

Operating instructions Compax3 I12T11

Positioning via digital I/Os & COM interface

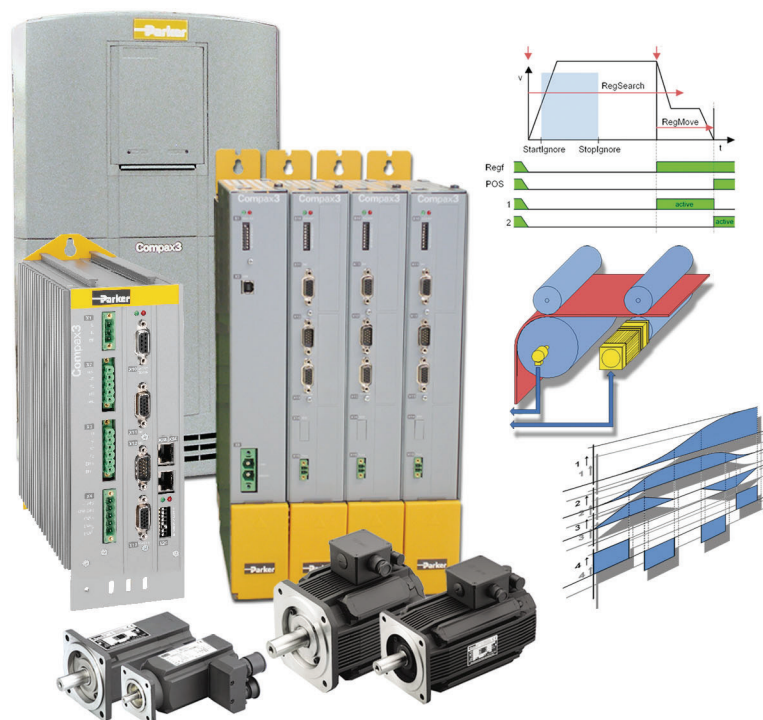

Release as from R09-63

192-120101 N09
C3I12T11
September 2014

Windows NT®, Windows 2000™, Windows XP™, Windows Vista, Windows 7 are trademarks of Microsoft Corporation.

Nonwarranty clause

We checked the contents of this publication for compliance with the associated hard and software. We can, however, not exclude discrepancies and do therefore not accept any liability for the exact compliance. The information in this publication is regularly checked, necessary corrections will be part of the subsequent publications.

Production site:



Parker Hannifin Manufacturing Germany GmbH & Co. KG
Electromechanical Automation Europe [EME]
Robert-Bosch-Strasse 22
77656 Offenburg (Germany)
Tel.: + 49 (0781) 509-0
Fax: + 49 (0781) 509-98176
Internet: www.parker.com/eme <http://www.parker.com/eme>
E-mail: sales.automation@parker.com <mailto:EM-Motion@parker.com>

Parker Hannifin GmbH - registered office: Bielefeld HRB 35489
Management Board: Ellen Raahede Secher, Dr.-Ing. Hans-Jürgen Haas, Günter Schrank, Kees Veraart - Chairman of the board of directors: Hansgeorg Greuner

Italy: Parker Hannifin Manufacturing Srl • SSD SBC • Electromechanical Automation •
Via Gounod, 1
I-20092 Cinisello Balsamo (MI), Italy
Tel.: +39 (0)2 361081 • Fax: +39 (0)2 36108400
E-mail: sales.automation@parker.com <mailto:sales.sbc@parker.com> •
Internet: www.parker.com/eme <http://www.parker.com/eme>

USA: Parker Hannifin Corporation • Electromechanical Automation
5500 Business Park Drive • Rohnert Park, CA 94928
Phone #: (800) 358-9068 • FAX #: (707) 584-3715
E-mail: CMR_help@parker.com mailto:emn_support@parker.com • Internet:
www.compumotor.com <http://www.compumotor.com>

NOTICE

Status of the Manuals:

Help and PDFs are updated simultaneously. In case of doubt the HTML help shows the actual state in comparison to PDF edition.

For additional HTML help please refer to our website. **Positioning via I/Os & RS232/RS485**
[http://www.Parker.com/Literature/Electromechanical Europe/user guides/C3112T11.chm](http://www.Parker.com/Literature/Electromechanical%20Europe/user%20guides/C3112T11.chm)

Inhalt

1. Introduction	10
1.1 Device assignment	10
1.2 Scope of delivery	10
1.3 Type specification plate	12
1.4 Packaging, transport, storage	13
1.5 Safety instructions.....	14
1.5.1. General hazards.....	14
1.5.2. Safety-conscious working	14
1.5.3. Special safety instructions	15
1.6 Warranty conditions	16
1.7 Conditions of utilization	17
1.7.1. Conditions of utilization for CE-conform operation.....	17
1.7.1.1 Conditions of utilization mains filter	17
1.7.1.2 Conditions of utilization for cables / motor filter	18
1.7.1.3 Additional conditions of utilization	19
1.7.2. Conditions of utilization for UL certification Compax3S.....	20
1.7.3. Conditions of utilization for UL approval Compax3M.....	21
1.7.4. Conditions of utilization for UL approval PSUP	22
1.7.5. Conditions of utilization for UL certification Compax3H.....	23
1.7.6. Current on the mains PE (leakage current).....	24
1.7.7. Supply networks	24
2. C3I12T11 Function overview	25
3. Compax3 device description	27
3.1 Meaning of the status LEDs - Compax3 axis controller	27
3.2 Meaning of the status LEDs - PSUP (mains module).....	28
3.3 Connections of Compax3S	29
3.3.1. Compax3S connectors.....	29
3.3.2. Connector and pin assignment C3S.....	30
3.3.3. Control voltage 24VDC / enable connector X4 C3S	32
3.3.4. Motor / Motor brake C3S connector X3	33
3.3.5. Compax3Sxxx V2.....	34
3.3.5.1 Main voltage supply C3S connector X1.....	34
3.3.5.2 Braking resistor / high voltage DC C3S connector X2.....	35
3.3.6. Compax3Sxxx V4.....	36
3.3.6.1 Power supply connector X1 for 3AC 400VAC/480VAC-C3S devices.....	36
3.3.6.2 Braking resistor / high voltage supply connector X2 for 3AC 400VAC/480VAC_C3S devices.....	37
3.3.6.3 Connection of the power voltage of 2 C3S 3AC devices.....	37
3.4 Installation instructions Compax3M	38
3.5 PSUP/Compax3M Connections	40
3.5.1. Front connector	40
3.5.2. Connections on the device bottom.....	41
3.5.3. Connections of the axis combination.....	42
3.5.4. Control voltage 24VDC PSUP (mains module)	43
3.5.5. Mains supply PSUP (mains module) X41	44
3.5.6. Braking resistor / temperature switch PSUP (mains module)	46

3.5.6.1	Temperature switch PSUP (mains module).....	47
3.5.7.	Motor / motor brake Compax3M (axis controller)	48
3.5.7.1	Measurement of the motor temperature of Compax3M (axis controller)	49
3.5.8.	X14 Safety technology option S1 for Compax3M (axis controller).....	49
3.5.9.	Safety technology option S3 for Compax3M (axis controller)	49
3.6	Connections of Compax3H	50
3.6.1.	Compax3H plugs/connections	50
3.6.2.	Connection of the power voltage	51
3.6.3.	Compax3H connections front plate	53
3.6.4.	Plug and pin assignment C3H	53
3.6.5.	Motor / Motor brake C3H	55
3.6.6.	Control voltage 24 VDC C3H.....	56
3.6.7.	Mains connection Compax3H.....	56
3.6.8.	Braking resistor / supply voltage C3H.....	57
3.6.8.1	Connect braking resistor C3H.....	57
3.6.8.2	Power supply voltage DC C3H	57
3.6.8.3	Connection of the power voltage of 2 C3H 3AC devices.....	57
3.7	Communication interfaces	58
3.7.1.	RS232 / RS485 interface (plug X10)	58
3.7.2.	Communication Compax3M	59
3.7.2.1	PC - PSUP (Mains module)	59
3.7.2.2	Communication in the axis combination (connector X30, X31)	59
3.7.2.3	Adjusting the basic address	60
3.7.2.4	Setting the axis function.....	60
3.8	Signal interfaces	61
3.8.1.	Resolver / Feedback (connector X13).....	61
3.8.2.	Analogue / encoder (plug X11)	63
3.8.2.1	Wiring of analog interfaces	63
3.8.2.2	Connections of the encoder interface	63
3.8.3.	Digital inputs/outputs (plug X12)	64
3.8.3.1	Connection of the digital Outputs/Inputs.....	65
3.8.3.2	Logic proximity switch types	65
3.9	Mounting and dimensions.....	66
3.9.1.	Mounting and dimensions Compax3S	66
3.9.1.1	Mounting and dimensions Compax3S0xxV2	66
3.9.1.2	Mounting and dimensions Compax3S100V2 and S0xxV4	67
3.9.1.3	Mounting and dimensions Compax3S150V2 and S150V4.....	68
3.9.1.4	Mounting and dimensions Compax3S300V4.....	69
3.9.2.	Mounting and dimensions PSUP/C3M.....	70
3.9.2.1	Mounting and dimensions PSUP10/C3M050D6, C3M100D6, C3M150D6	70
3.9.2.2	Mounting and dimensions PSUP20/PSUP30/C3M300D6.....	71
3.9.2.3	With upper mounting, the housing design may be different	71
3.9.3.	Mounting and dimensions C3H.....	72
3.9.3.1	Mounting distances, air currents Compax3H050V4	73
3.9.3.2	Mounting distances, air currents Compax3H090V4	73
3.9.3.3	Mounting distances, air currents Compax3H1xxV4.....	74
3.10	Safety function - STO (=safe torque off)	75
3.10.1.	General Description.....	75
3.10.1.1	Important terms and explanations	75
3.10.1.2	Intended use	76
3.10.1.3	Advantages of using the "safe torque off" safety function.	76
3.10.1.4	Devices with the STO (=safe torque off) safety function	77
3.10.2.	STO (= safe torque off) with Compax3S.....	78

3.10.2.1	STO Principle (= Safe Torque Off) with Compax3S	78
3.10.2.2	Conditions of utilization STO (=safe torque off) Safety function	80
3.10.2.3	Notes on the STO function.....	80
3.10.2.4	STO application example (= safe torque off)	81
3.10.2.5	Technical Characteristics STO Compax3S	84
3.10.3.	STO (= safe torque off) with Compax3m (Option S1).....	85
3.10.3.1	Safety switching circuits.....	85
3.10.3.2	Safety notes for the STO function in the Compax3M	86
3.10.3.3	Conditions of utilization for the STO function with Compax3M.....	86
3.10.3.4	STO delay times	87
3.10.3.5	Compax3M STO application description	88
3.10.3.6	STO function test	91
3.10.3.7	Technical details of the Compax3M S1 option	93

4. Setting up Compax3.....94

4.1	Configuration	94
4.1.1.	Selection of the supply voltage used	95
4.1.2.	Motor selection	96
4.1.3.	Optimize motor reference point and switching frequency of the motor current	96
4.1.4.	Ballast resistor.....	99
4.1.5.	General drive.....	99
4.1.6.	Defining the reference system	100
4.1.6.1	Measure reference.....	100
4.1.6.2	Machine Zero	103
4.1.6.3	Travel Limit Settings	120
4.1.6.4	Change assignment direction reversal / limit switches	123
4.1.6.5	Change initiator logic	123
4.1.7.	Defining jerk / ramps	124
4.1.7.1	Jerk limitation	124
4.1.7.2	Ramp upon error / deenergize.....	125
4.1.8.	Limit and monitoring settings	126
4.1.8.1	Current (Torque) Limit.....	126
4.1.8.2	Positioning window - Position reached	126
4.1.8.3	Following error limit.....	128
4.1.8.4	Maximum operating speed.....	128
4.1.9.	Operating mode / I/O assignment	129
4.1.9.1	I/O assignment for control via the Compax3 inputs/outputs	129
4.1.9.2	I/O assignment, control word and status word with control via COM port.....	130
4.1.10.	Encoder simulation	134
4.1.10.1	Encoder bypass with Feedback module F12 (for direct drives).....	134
4.1.11.	Absolute- /continuous mode	135
4.1.12.	Position mode in reset operation.....	135
4.1.13.	Defining the STOP function.....	135
4.1.14.	Reg-related positioning / defining ignore zone	137
4.1.15.	Write into set table.....	138
4.1.15.1	Dynamic positioning	139
4.1.15.2	Programmable status bits (PSBs).....	139
4.1.15.3	Set selection	140
4.1.15.4	MoveAbs and MoveRel.....	140
4.1.15.5	Reg-related positioning (RegSearch, RegMove).....	141
4.1.15.6	Electronic gearbox (Gearing).....	145
4.1.15.7	Speed specification (Velocity).....	147
4.1.15.8	Stop command (Stop)	147
4.1.16.	Error response	147
4.1.17.	Configuration name / comments.....	147

4.2	Configuring the signal Source	148
4.2.1.	Signal source of the load feedback system	148
4.2.2.	Select signal source for Gearing	148
4.2.2.1	Signal source HEDA	149
4.2.2.2	Encoder A/B 5V, step/direction or SSI feedback as signal source	150
4.2.2.3	+/-10V analog speed setpoint value as signal source	151
4.3	Load control	153
4.3.1.	Configuration of load control	154
4.3.2.	Error: Position difference between load mounted and motor feedback too high	155
4.3.3.	Load control signal image	155
4.4	Optimization	156
4.4.1.	Optimization window	156
4.4.2.	Scope	157
4.4.2.1	Monitor information	157
4.4.2.2	User interface	158
4.4.2.3	Example: Setting the Oscilloscope	162
4.4.3.	Controller optimization	164
4.4.3.1	Introduction	164
4.4.3.2	Configuration	166
4.4.3.3	Automatic controller design	182
4.4.3.4	Setup and optimization of the control	194
4.4.4.	Signal filtering with external command value	224
4.4.4.1	Signal filtering for external setpoint specification and electronic gearbox	225
4.4.5.	Input simulation	226
4.4.5.1	Calling up the input simulation	226
4.4.5.2	Operating Principle	226
4.4.6.	Setup mode	227
4.4.6.1	Motion objects in Compax3	228
4.4.7.	Load identification	229
4.4.7.1	Principle	229
4.4.7.2	Boundary conditions	229
4.4.7.3	Process of the automatic determination of the load characteristic value (load identification)	230
4.4.7.4	Tips	231
4.4.8.	Alignment of the analog inputs	231
4.4.8.1	Offset alignment	231
4.4.8.2	Gain alignment	232
4.4.8.3	Signal processing of the analog inputs	232
4.4.9.	C3 ServoSignalAnalyzer	233
4.4.9.1	ServoSignalAnalyzer - function range	233
4.4.9.2	Signal analysis overview	234
4.4.9.3	Installation and activation of the ServoSignalAnalyzer	235
4.4.9.4	Analyses in the time range	236
4.4.9.5	Measurement of frequency spectra	239
4.4.9.6	Measurement of frequency responses	242
4.4.9.7	Overview of the user interface	248
4.4.9.8	Basics of frequency response measurement	261
4.4.10.	ProfileViewer for the optimization of the motion profile	266
4.4.10.1	Mode 1: Time and maximum values are deduced from Compax3 input values	266
4.4.10.2	Mode 2: Compax3 input values are deduced from times and maximum values	267
4.4.11.	Turning the motor holding brake on and off	268

5. Control via RS232 / RS485 / USB	269
5.1 Status diagram	270
5.2 I/O assignment, control word and status word with control via COM port	271
5.2.1 I/O Assignment	271
5.2.2 Control Word	273
5.2.3 Status word 1 & 2	274
5.3 Examples include: Control via COM port.....	275
5.4 Layout of the set table	277
5.4.1 General layout of the table.....	277
5.4.2 Assignment of the different motion functions.....	277
5.4.3 Definition of the states of the programmable status bits (PSBs):.....	278
5.5 Compax3 communication variants	278
5.5.1 PC <-> Compax3 (RS232).....	279
5.5.2 PC <-> Compax3 (RS485).....	280
5.5.3 PC <-> C3M device combination (USB)	281
5.5.4 USB-RS485 Moxa Uport 1130 adapter	282
5.5.5 ETHERNET-RS485 NetCOM 113 adapter	283
5.5.6 Modem MB-Connectline MDH 500 / MDH 504	284
5.5.7 C3 settings for RS485 two wire operation.....	285
5.5.8 C3 settings for RS485 four wire operation	286
5.6 COM port protocol	287
5.6.1 RS485 settings values	287
5.6.2 ASCII - record	287
5.6.3 Binary record	288
5.7 Remote diagnosis via Modem.....	292
5.7.1 Structure	292
5.7.2 Configuration of local modem 1	293
5.7.3 Configuration of remote modem 2	294
5.7.4 Recommendations for preparing the modem operation	294
6. Compax3 - Objects	295
6.1 Objekt Overview I12 T11.....	296
7. Status values	300
7.1 D/A-Monitor	300
8. Error	301
9. Order code	302
9.1 Order code device: Compax3	303
9.2 Order code for mains module: PSUP	304
9.3 Order code for accessories.....	304
9.3.1 Order code for feedback cables	305
9.3.2 Order Code braking resistors.....	305
9.3.3 Order code mains filter (C3S).....	306
9.3.4 Order code capacitor module.....	306
9.3.5 Interface cable order code	307
9.3.6 Order Code input/output terminals (PIO)	307
9.3.7 Order note.....	308

10. Compax3 Accessories	309
10.1 Parker servo motors	309
10.1.1. Direct drives	309
10.1.1.1 Transmitter systems for direct drives	310
10.1.1.2 Linear motors	311
10.1.1.3 Torque motors.....	311
10.1.2. Rotary servo motors.....	311
10.2 EMC measures	312
10.2.1. Mains filter	312
10.2.1.1 Mains filter NFI01/01	313
10.2.1.2 Mains filter NFI01/02.....	313
10.2.1.3 Mains filter for NFI01/03.....	314
10.2.1.4 Mains filter NFI02/0x	314
10.2.1.5 Mains filter NFI03/01& NFI03/03	315
10.2.1.6 Mains filter NFI03/02.....	316
10.2.2. Motor output filter.....	317
10.2.2.1 Motor output filter MDR01/04.....	317
10.2.2.2 Motor output filter MDR01/01.....	317
10.2.2.3 Motor output filter MDR01/02.....	318
10.2.2.4 Wiring of the motor output filter.....	318
10.2.3. Mains chokes	319
10.2.3.1 Mains filter for PSUP30.....	319
10.3 Connections to the motor	320
10.3.1. Resolver cable	321
10.3.2. SinCos© cable.....	322
10.3.3. EnDat cable	322
10.3.4. Motor cable.....	323
10.3.4.1 Connection of terminal box MH145 & MH205	323
10.3.5. Encoder cable	324
10.4 External braking resistors.....	325
10.4.1. Permissible braking pulse powers of the braking resistors	326
10.4.1.1 Calculation of the BRM cooling time.....	326
10.4.1.2 Permissible braking pulse power: BRM08/01 with C3S015V4 / C3S038V4.....	327
10.4.1.3 Permissible braking pulse power: BRM08/01 with C3S025V2	328
10.4.1.4 Permissible braking pulse power: BRM09/01 with C3S100V2	328
10.4.1.5 Permissible braking pulse power: BRM10/01 with C3S150V4	329
10.4.1.6 Permissible braking pulse power: BRM10/02 with C3S150V4	329
10.4.1.7 Permissible braking pulse power: BRM05/01 with C3S063V2	330
10.4.1.8 Permissible braking pulse power: BRM05/01 with C3S075V4	330
10.4.1.9 Permissible braking pulse power: BRM05/02 with C3S075V4	331
10.4.1.10 Permissible braking pulse power: BRM04/01 with C3S150V2	331
10.4.1.11 Permissible braking pulse power: BRM04/01 with C3S300V4	332
10.4.1.12 Permissible braking pulse power: BRM04/02 with C3S150V2	332
10.4.1.13 Permissible braking pulse power: BRM04/02 with C3S300V4	333
10.4.1.14 Permissible braking pulse power: BRM04/03 with C3S300V4	333
10.4.1.15 Permissible braking pulse power: BRM11/01 with C3H0xxV4	334
10.4.1.16 Permissible braking pulse power: BRM12/01 with C3H1xxV4	334
10.4.1.17 Permissible braking pulse power: BRM13/01 with PSUP10D6	335
10.4.1.18 Permissible braking pulse power: BRM14/01 with PSUP10D6	335
10.4.2. Dimensions of the braking resistors	335
10.4.2.1 BRM8/01 braking resistors.....	335
10.4.2.2 BRM5/01 braking resistor	335
10.4.2.3 Braking resistor BRM5/02, BRM9/01 & BRM10/01	336
10.4.2.4 Braking resistor BRM4/0x and BRM10/02.....	336

10.4.2.5	Braking resistor BRM11/01 & BRM12/01	337
10.4.2.6	Ballast resistor BRM13/01 & BRM14/01	337
10.5	Capacitor module C4	338
10.6	Operator control module BDM	339
10.7	EAM06: terminal block for inputs and outputs	339
10.8	Interface cable	342
10.8.1.	RS232 - cable / SSK1	342
10.8.2.	RS485 cable to Pop / SSK27	343
10.8.3.	I/O-interface X12 / X22 / SSK22	344
10.8.4.	Ref X11 / SSK21	344
10.8.5.	Encoder coupling of 2 Compax3 axes / SSK29	345
10.8.6.	Modem cable SSK31	346
10.8.7.	Adapter cable SSK32/20	346
10.9	Options M1x	347
10.9.1.	Digital input/output option M12 (I12)	347
10.9.1.1	Assignment of the X22 connector	347
10.9.2.	HEDA (motion bus) - Option M11	348
10.9.3.	Option M10 = HEDA (M11) & I/Os (M12)	349
11.	Technical Data	350
12.	Index	366

1. Introduction

In this chapter you can read about:

Device assignment	10
Scope of delivery	10
Type specification plate	12
Packaging, transport, storage	13
Safety instructions	14
Warranty conditions	16
Conditions of utilization	17

1.1 Device assignment

This manual is valid for the following devices:

- ◆ Compax3S025V2 + supplement
- ◆ Compax3S063V2 + supplement
- ◆ Compax3S100V2 + supplement
- ◆ Compax3S150V2 + supplement
- ◆ Compax3S015V4 + supplement
- ◆ Compax3S038V4 + supplement
- ◆ Compax3S075V4 + supplement
- ◆ Compax3S150V4 + supplement
- ◆ Compax3S300V4 + supplement
- ◆ Compax3H050V4 + supplement
- ◆ Compax3H090V4 + supplement
- ◆ Compax3H125V4 + supplement
- ◆ Compax3H155V4 + supplement
- ◆ Compax3M050D6 + supplement - Safety Option S1
- ◆ Compax3M100D6 + supplement - Safety Option S1
- ◆ Compax3M150D6 + supplement - Safety Option S1
- ◆ Compax3M300D6 + supplement - Safety Option S1
- ◆ PSUP10D6
- ◆ PSUP20D6
- ◆ PSUP30D6

With the supplement:

- ◆ F10 (Resolver)
- ◆ F11 (SinCos®)
- ◆ F12 (linear and rotary direct drives)
- ◆ I12 T11

1.2 Scope of delivery

The following items are furnished with the device:

- ◆ Manuals*
 - ◆ Installation manual (German, English, French)
 - ◆ Compax3 DVD
 - ◆ Startup Guide (German / English)

*Comprehensiveness of documentation depends on device type

- ◆ Device accessories
 - Device accessories for Compax3S
 - ◆ Cable clamps in different sizes for large area shielding of the motor cable, the screw for the cable clamp as well as
 - ◆ the mating plug connectors for the Compax3S plug connectors X1, X2, X3, and X4
 - ◆ a toroidal core ferrite for one cable of the motor holding brake
 - ◆ Lacing cord
 - ◆ Device accessories for Compax3M
 - ◆ Cable clamps in different sizes for large area shielding of the motor cable, the screw for the cable clamp as well as
 - ◆ the matching plug for the Compax3M connectors X14, X15, X43
 - ◆ a toroidal core ferrite for a cable of the motor holding brake
 - ◆ an interface cable (SSK28/23) for communication within the axis combination
 - ◆ With safety option S3: Mating plugs X28 and connection cable X26 / X27
 - ◆ Device accessories for PSUP
 - ◆ Matching plug for the PSUP connectors X9, X40, X41
 - ◆ 2 bus terminal connectors (BUS07/01) for mains module and the last axis controller in the combination
 - ◆ Device accessories for Compax3H
 - ◆ Mating connector for X3 and X4
 - ◆ SSK32/20: RS232 adapter cable (programming port C3HxxxV4 - SSK1 - PC)
 - ◆ VBK17/01: SubD jumper mounted

1.3 Type specification plate

Compax3 - Type
specification plate
(example):

The present device type is defined by the type specification plate (on the housing):



Explanation:

1	Type designation: The complete order designation of the device (2, 5, 6, 9, 8).
2	C3 : Abbreviation for Compax3
	S025 : Single axis device, nominal device current in 100mA (025=2.5A) M050 : Multi-axis device, nominal device current in 100mA (050=5A) H050 : High power device, nominal device current in 1A (050=50A)
3	D6 : Designation nominal supply V2 : Mains supply voltage (2=230VAC/240VAC, 4=400VAC/480VAC)
	Unique number of the particular device
4	Nominal supply voltage Power Input: Input supply data Power Output: Output data
5	Designation of the feedback system F10 : Resolver F11 : SinCos® / Single- or Multiturn F12 : Feedback module for direct drives
6	Device interface I10 : Analog, step/direction and encoder input I11 / I12 : Digital Inputs / Outputs and RS232 / RS485 I20 : Profibus DP / I21 : CANopen / I22 : DeviceNet / I30 : Ethernet Powerlink / I31 : EtherCAT / I32 : Profinet C20 : integrated controller C3 <i>powerPLmC</i> , Linux & Web server
7	Date of factory test
8	Options Mxx : I/O extension, HEDA Sx : optional safety technology on C3M
9	Technology function T10 : Servo controller T11 : Positioning T20 : Pressure / Volume flow rate T30 : Motion control in accordance with IEC61131-3 T40 : Electronic cam
10	CE compliance
11	Certified safety technology (corresponding to the logo displayed)
12	UL certified (corresponding to the logo displayed)

1.4 Packaging, transport, storage

Packaging material and transport



Caution!

The packaging material is inflammable, if it is disposed of improperly by burning, lethal fumes may develop.

The packaging material must be kept and reused in the case of a return shipment. Improper or faulty packaging may lead to transport damages.

Make sure to transport the drive always in a safe manner and with the aid of suitable lifting equipment (**Weight** (see on page 350, see on page 361)). Do never use the electric connections for lifting. Before the transport, a clean, level surface should be prepared to place the device on. The electric connections may not be damaged when placing the device.

First device checkup

- ◆ Check the device for signs of transport damages.
- ◆ Please verify, if the indications on the **Type identification plate** (see on page 12) correspond to your requirements.
- ◆ Check if the consignment is complete.

Disposal

This product contains materials that fall under the special disposal regulation from 1996, which corresponds to the EC directory 91/689/EEC for dangerous disposal material. We recommend to dispose of the respective materials in accordance with the respectively valid environmental laws. The following table states the materials suitable for recycling and the materials which have to be disposed of separately.

Material	suitable for recycling	Disposal
Metal	yes	no
Plastic materials	yes	no
Circuit boards	no	yes

Please dispose of the circuit boards according to one of the following methods:

- ◆ Burning at high temperatures (at least 1200°C) in an incineration plant licensed in accordance with part A or B of the environmental protection act.
- ◆ Disposal via a technical waste dump which is allowed to take on electrolytic aluminum condensers. Do under no circumstances dump the circuit boards at a place near a normal waste dump.

Storage

If you do not wish to mount and install the device immediately, make sure to store it in a dry and clean **environment** (see on page 363). Make sure that the device is not stored near strong heat sources and that no metal chippings can get into the device.

Please note in the event of storage >1 year:

Forming the capacitors

Forming the capacitors only required with 400VAC axis controllers and PSUP mains module

If the device was stored longer than one year, the intermediate capacitors must be re-formed!

Forming sequence:

- ◆ Remove all electric connections
- ◆ Supply the device with 230VAC single phase for 30 minutes
 - ◆ via the L1 and L2 terminals on the device or
 - ◆ multi axis devices via L1 and L2 on the PSUP mains module

1.5 Safety instructions

In this chapter you can read about:

General hazards	14
Safety-conscious working	14
Special safety instructions	15

1.5.1. General hazards

General Hazards on Non-Compliance with the Safety Instructions

The device described in this manual is designed in accordance with the latest technology and is safe in operation. Nevertheless, the device can entail certain hazards if used improperly or for purposes other than those explicitly intended.

Electronic, moving and rotating components can

- ◆ constitute a hazard for body and life of the user, and
- ◆ cause material damage

Designated use

The device is designed for operation in electric power drive systems (VDE0160). Motion sequences can be automated with this device. Several motion sequences can be combined by interconnecting several of these devices. Mutual interlocking functions must be incorporated for this purpose.

1.5.2. Safety-conscious working

This device may be operated only by qualified personnel.

Qualified personnel in the sense of these operating instructions consists of:

- ◆ Persons who, by virtue to their training, experience and instruction, and their knowledge of pertinent norms, specifications, accident prevention regulations and operational relationships, have been authorized by the officer responsible for the safety of the system to perform the required task and in the process are capable of recognizing potential hazards and avoiding them (definition of technical personnel according to VDE105 or IEC364),
- ◆ Persons who have a knowledge of first-aid techniques and the local emergency rescue services.
- ◆ persons who have read and will observe the safety instructions.
- ◆ Those who have read and observe the manual or help (or the sections pertinent to the work to be carried out).

This applies to all work relating to setting up, commissioning, configuring, programming, modifying the conditions of utilization and operating modes, and to maintenance work.

This manual and the help information must be available close to the device during the performance of all tasks.

1.5.3. Special safety instructions



Caution!

Due to movable machine parts and high voltages, the device can pose a lethal danger. Danger of electric shock in the case of non-respect of the following instructions. The device corresponds to DIN EN 61800-3, i.e. it is subject to limited sale. The device can emit disturbances in certain local environments. In this case, the user is liable to take suitable measures.

- ◆ Check that all live terminals are secured against contact. Perilous voltage levels of up to 850V occur.
- ◆ Do not bypass power direct current

Be cautious when performing configuration downloads with master - slave couplings (electronic gear, cam) Deactivate the drive before starting the configuration download: Master and Slave axis.



Caution!

Due to movable machine parts and high voltages, the device can pose a lethal danger. Danger of electric shock in the case of non-respect of the following instructions. The device corresponds to DIN EN 61800-3, i.e. it is subject to limited sale. The device can emit disturbances in certain local environments. In this case, the user is liable to take suitable measures.

- ◆ The device must be permanently grounded due to high earth leakage currents.
- ◆ The drive motor must be grounded with a suitable protective lead.
- ◆ The devices are equipped with high voltage DC condensers. Before removing the protective cover, the discharging time must be awaited. After switching off the supply voltage, it may take up to 10 minutes (with additional capacity modules it may take up to 30 minutes) to discharge the capacitors.
Danger of electric shock in case of non respect.
- ◆ Before you can work on the device, the supply voltage must be switched off at the L1, L2 and L3 clamps. Wait at least 10 minutes so that the power direct current may sink to a secure value (<50V). Check with the aid of a voltmeter, if the voltage at the DC+ and DC- clamps has fallen to a value below 50V.
Danger of electric shock in case of non respect.
- ◆ Do never perform resistance tests with elevated voltages (over 690V) on the wiring without separating the circuit to be tested from the drive.
- ◆ Please exchange devices only in currentless state and, in an axis system, only in a defined original state.
- ◆ If the axis controller is replaced, it is absolutely necessary to transfer the configuration determining the correct operation of the drive to the device, before the device is put into operation. Depending on the operation mode, a machine zero run will be necessary.
- ◆ The device contains electrostatically sensitive components. Please heed the electrostatic protection measures while working at/with the device as well as during installation and maintenance.
- ◆ Operation of the PSUP30 only with line choke.



Attention - hot surface!

The heat dissipater can reach very high temperatures (>70°C)

Protective seals



Caution!

The user is responsible for protective covers and/or additional safety measures in order to prevent damages to persons and electric accidents.

Please note in the event of storage >1 year:

Forming the capacitors

Forming the capacitors only required with 400VAC axis controllers and PSUP mains module

If the device was stored longer than one year, the intermediate capacitors must be re-formed!

Forming sequence:

- ◆ Remove all electric connections
- ◆ Supply the device with 230VAC single phase for 30 minutes
 - ◆ via the L1 and L2 terminals on the device or
 - ◆ multi axis devices via L1 and L2 on the PSUP mains module

1.6 Warranty conditions

- ◆ The device must not be opened.
- ◆ Do not make any modifications to the device, except for those described in the manual.
- ◆ Make connections to the inputs, outputs and interfaces only in the manner described in the manual.
- ◆ Fix the devices according to the **mounting instructions**. (see on page 66, see on page 72)

We cannot provide any guarantee for other mounting methods.

Note on exchange of options

Device options must be exchanged in the factory to ensure hardware and software compatibility.

- ◆ When installing the device, make sure the heat dissipators of the device receive sufficient air and respect the recommended mounting distances of the devices with integrated ventilator fans in order to ensure free circulation of the cooling air.
- ◆ Make sure that the mounting plate is not exposed to external temperature influences.

1.7 Conditions of utilization

In this chapter you can read about:

Conditions of utilization for CE-conform operation	17
Conditions of utilization for UL certification Compax3S	20
Conditions of utilization for UL approval Compax3M	21
Conditions of utilization for UL approval PSUP	22
Conditions of utilization for UL certification Compax3H	23
Current on the mains PE (leakage current)	24
Supply networks	24

1.7.1. Conditions of utilization for CE-conform operation

- Industry and trade -

The EC guidelines for electromagnetic compatibility 2004/108/EC and for electrical operating devices for utilization within certain voltage limits 2006/95/EC are fulfilled when the following boundary conditions are observed:

Operation of devices only in the state in which they are delivered.

In order to ensure contact protection, all mating plugs must be present on the device connections even if they are not wired.

Please respect the specifications of the manual, especially the technical characteristics (mains connection, circuit breakers, output data, ambient conditions,...).

1.7.1.1 Conditions of utilization mains filter

Mains filter: A mains filter is required in the mains input line if the motor cable exceeds a certain length. Filtering can be provided centrally at the system mains input or separately for each device or with C3M for each axis system.

Use of the devices in a commercial and residential area (limit value class in accordance with EN 61800-3)

The following mains filters are available for independent utilization:

Device: Compax3S	Limit value class	Motor cable length	Mains filter Order No.:
S0xxV2	C2	< 10 m	without
	C2	> 10 m, < 100 m	NFI01/01
S1xxV2, S0xxV4, S150V4	C2	< 10 m	without
	C2	> 10 m, < 100 m	NFI01/02
S300V4	C3	< 10 m	without
	C2, C3	> 10 m, < 100 m	NFI01/03
Device: Compax3H	Limit value class	Motor cable length	Mains filter Order No.:
H050V4	C2	< 10 m	without
	C2	> 10 m, < 50 m	NFI02/01
H090V4	C2	< 10 m	without
	C2	> 10 m, < 50 m	NFI02/02
H1xxV4	C2	< 10 m	without
	C2	> 10 m, < 50 m	NFI02/03

Use of the devices in the industrial area (limit values class C3 in accordance with EN 61800-3)

The following mains filters are available for independent utilization:

Device: PSU	Limit value class	Reference: Axis system with motor cable	Mains filter Order No.:
P10	C3	< 6 x 10 m	NFI03/01
P10	C3	< 6 x 50 m	NFI03/02
P20	C3	< 6 x 50 m	NFI03/03
P30	C3	< 6 x 50 m	NFI03/03

Connection length: Connection between mains filter and device:

unshielded: < 0.5 m
shielded < 5 (fully shielded on ground - e.g. ground of control cabinet)

1.7.1.2 Conditions of utilization for cables / motor filter

Motor and Feedback cable: Operation of the devices only with motor and feedback cables whose plugs contain a special full surface area screening.

Compax3S motor cable < 100 m (the cable should not be rolled up!)
A **motor output filter** (see on page 317) is required for motor cables >20 m:
◆ MDR01/04 (max. 6.3 A rated motor current)
◆ MDR01/01 (max. 16 A rated motor current)
◆ MDR01/02 (max. 30 A rated motor current)

Compax3H motor cable A motor output filter is required for motor cables >50m. Please contact us.

Compax3M motor cable <80m per axis (the cable must not be rolled up!)
The entire length of the motor cable per axis combination may not exceed 300m.
A **motor output filter** (see on page 317) is required for motor cables >20 m:
◆ MDR01/04 (max. 6.3 A rated motor current)
◆ MDR01/01 (max. 16 A rated motor current)
◆ MDR01/02 (max. 30 A rated motor current)

Shielding connection of the motor cable

The cable must be fully-screened and connected to the Compax3 housing. Use the cable clamps/shield connecting terminals furnished with the device.

The shield of the cable must also be connected with the motor housing. The fixing (via plug or screw in the terminal box) depends on the motor type.

Feedback cable < 100 m
Compax3S,
Compax3H &
Compax3F:

Compax3M encoder cable: < 80m

Cable für Compax3S, Compax3M Corresponding to the specifications of the terminal clamp with a temperature range of up to 60°C.

Cable für Compax3H Corresponding to the specifications of the terminal clamp with a temperature range of up to 75°C.

- Cable installation:**
- ◆ Signal lines and power lines should be installed as far apart as possible.
 - ◆ Signal lines should never pass close to excessive sources of interference (motors, transformers, contactors etc.).
 - ◆ Do not place mains filter output cable parallel to the load cable.

1.7.1.3 Additional conditions of utilization

Motors: Operation with standard motors.

Control: Use only with aligned controller (to avoid control loop oscillation).

Grounding: Connect the filter housing and the device to the cabinet frame, making sure that the contact area is adequate and that the connection has low resistance and low inductance.

Never mount the filter housing and the device on paint-coated surfaces!

Compax3S300V4 For CE and UL conform operation of the Compax3S300V4, a mains filter is compulsory:

- ◆ 400 VAC / 0.740 mH certified in accordance with EN 61558-1 bzw. 61558-2-2
- ◆ We offer the mains filter as an accessory: LIR01/01

Accessories: Make sure to use only the accessories recommended by Parker

Connect all cable shields at both ends, ensuring large contact areas!

Warning:

This is a product in the restricted sales distribution class according to EN 61800-3. In a domestic area this product can cause radio frequency disturbance, in which case the user may be required to implement appropriate remedial measures.

1.7.2. Conditions of utilization for UL certification Compax3S

UL certification for Compax3S

conform to UL:	◆ according to UL508C
Certified	◆ E-File_No.: E235342

The UL certification is documented by a "UL" logo on the device (type specification plate).



Conditions of utilization

- ◆ The devices are only to be installed in a degree of contamination 2 environment (maximum).
- ◆ The devices must be appropriately protected (e.g. by a switching cabinet).
- ◆ The X2 terminals are not suitable for field wiring.
- ◆ Tightening torque of the field wiring terminals (green Phoenix plugs)
 - ◆ C3S0xxV2 0.57 - 0.79Nm 5 - 7Lb.in
 - ◆ C3S1xxV2, 0.57 - 0.79Nm 5 - 7Lb.in
 - C3S0xxV4, C3S150V4
 - ◆ C3S300V4 1.25 - 1.7Nm 11 - 15Lb.in
- ◆ Temperature rating of field installed conductors shall be at least 60°C. Use copper lines only
Please use the cables described in the **accessories chapter** (see on page 302, see on page 304), they feature a temperature rating of at least 60°C.
- ◆ Maximum Surrounding Air Temperature: 45°C.
- ◆ Motor over temperature monitoring is only supported, if the external temperature sensor is connected.
- ◆ Suitable for use on a circuit capable of delivering at least 5000 symmetrical amperes effectively and 480 Volts when protected with fuses.
Fuses:
In addition to the main fuse, the devices must be equipped with a S201K, S203K, S271K or S273K circuit breaker with K characteristic made by ABB.
 - ◆ C3S025V2: ABB, nom 480V 10A, 6kA
 - ◆ C3S063V2: ABB, nom 480V, 16A, 6kA
 - ◆ C3S100V2: ABB, nom 480V, 16A, 6kA
 - ◆ C3S150V2: ABB, nom 480V, 20A, 6kA
 - ◆ C3S015V4: ABB, nom 480V, 6A, 6kA
 - ◆ C3S038V4: ABB, nom 480V, 10A, 6kA
 - ◆ C3S075V4: ABB, nom 480V, 16A, 6kA
 - ◆ C3S150V4: ABB, nom 480V, 20A, 6kA
 - ◆ C3S300V4: ABB, nom 480V, 25A, 6kA



CAUTION

Risk of electric shock.
Discharge time of the bus capacitor is 10 minutes.

- ◆ The drive provides internal motor overload protection.
This must be set so that 200% of the motor nominal current are not exceeded.
- ◆ Cable cross-sections
 - ◆ Mains input: corresponding to the recommended fuses.
 - ◆ Motor cable: corresponding to the **Nominal output currents** (see on page 352, see on page 353)
 - ◆ Maximum cross-section limited by the terminals mm² / AWG
 - ◆ C3S0xxV2 2.5mm² AWG 12
 - ◆ C3S1xxV2, 4.0mm² AWG 10
 - C3S0xxV4, C3S150V4
 - ◆ C3S300V4 6.0mm² AWG 7

1.7.3. Conditions of utilization for UL approval Compax3M

UL approval for Compax3M

Conform to UL:	◆ in accordance with UL508C
Certified	◆ E-File_No.: E235342

The UL approval is documented by a "UL" logo on the device (type specification plate).



Conditions of utilization

- ◆ The devices are only to be installed in a degree of contamination 2 environment (maximum).
- ◆ The devices must be appropriately protected (e.g. by a switching cabinet).
- ◆ Tightening torque of the field wiring terminals (green Phoenix plugs)

Device	X43: Motor connector	X15: Temperature monitoring
C3M050-150	0.5Nm (4.43Lb.in)	0.22Nm (1.95Lb.in)
C3M300	1.2Nm (10.62Lb.in)	0.22Nm (1.95Lb.in)

- ◆ Temperature rating of field installed conductors shall be at least 60°C. Use copper lines only
Please use the cables described in the **accessories chapter** (see on page 302, see on page 304), they feature a temperature rating of at least 60°C.
- ◆ Maximum Surrounding Air Temperature: 40°C.
- ◆ Control voltage supply (24VDC) only permissible with "class 2" power supply.
- ◆ Compax3M may only be operated with a mains module of the PSUP series.
- ◆ Motor Over Temperature sensing is not provided by the drive unless the external temperature sensor is connected.



Caution!

Risk of electric shock.

Discharge time of the bus capacitor is 10 minutes.

The drive provides internal motor overload protection.

This must be set so that 200% of the motor nominal current are not exceeded.

- ◆ Cable cross-sections
 - ◆ Mains input: corresponding to the recommended fuses.
 - ◆ Motor cable: corresponding to the **Nominal output currents** (see on page 352, see on page 353)
- ◆ Maximum cross-section limited by the terminals mm² / AWG

Line cross-sections of the power connections (on the device bottoms)

Compax3 device:	Cross-section: Minimum... Maximum [with conductor sleeve]
M050, M100, M150	0.25 ... 4 mm ² (AWG: 23 ... 11)
M300	0.5 ... 6 mm ² (AWG: 20 ... 10)

1.7.4. Conditions of utilization for UL approval PSUP

UL approval for mains modules PSUP

Conform to UL:	◆ in accordance with UL508C
Certified	◆ E-File_No.: E235342

The UL approval is documented by a "UL" logo on the device (type specification plate).



UL approval PSUP30 in preparation!

Conditions of utilization

- ◆ The devices are only to be installed in a degree of contamination 2 environment (maximum).
- ◆ The devices must be appropriately protected (e.g. by a switching cabinet).
- ◆ Tightening torque of the field wiring terminals (green Phoenix plugs)

Device	X40: Ballast resistor	X41: Mains connector	X9: 24VDC
PSUP10	0.5 Nm (4.43Lb.in)	1.2 Nm (10.62Lb.in)	1.2 Nm (10.62Lb.in)
PSUP20	0.5 Nm (4.43Lb.in)	1.7 Nm (15Lb.in)	1.2 Nm (10.62Lb.in)
PSUP30	UL approval in preparation		

- ◆ Temperature rating of field installed conductors shall be at least 60°C. Use copper lines only
Please use the cables described in the **accessories chapter** (see on page 302, see on page 304), they feature a temperature rating of at least 60°C.
- ◆ Maximum Surrounding Air Temperature: 40°C.
- ◆ Control voltage supply (24VDC) only permissible with "class 2" power supply.
- ◆ Suitable for use on a circuit capable of delivering not more than 5000 rms symmetrical amperes and 480 volts maximum and protected by (see below).
- ◆ The devices need a "branch circuit protection".

PSUP10D6

Maximum fuse rating per device	Measure for line and device protection: MCB miniature circuit breaker (K characteristic) 25A in accordance with UL category DIVQ (ABB) S203UP-K25 (480VAC)
---------------------------------------	---

PSUP20D6

Maximum fuse rating per device 2 special purpose fuses in line are required	Cable protection measure: MCB (K characteristic) with a rating of 50A / 4xxVAC (depending on the input voltage). (ABB) S203U-K50 (440VAC) Device protection measure: Fuses 80A / 700VAC per supply leg in accordance with UL category JFHR2: Bussmann 170M1366 or 170M1566D
--	---



Caution!

Risk of electric shock.
Discharge time of the bus capacitor is 10 minutes.

1.7.5. Conditions of utilization for UL certification Compax3H

UL certification for Compax3H

Conform to UL:	◆ according to UL508C
Certified	◆ E-File_No.: E235342

The UL certification is documented by a "UL" logo on the device (type specification plate).



Conditions of utilization

- ◆ The devices are only to be installed in a degree of contamination 2 environment (maximum).
- ◆ The devices must be appropriately protected (e.g. by a switching cabinet).
- ◆ Tightening Torque of the Field Wiring Terminals.

Terminal clamps - max. line cross sections

The line cross sections must correspond to the locally valid safety regulations. The local regulations have always priority.

	Power clamps (minimum/maximum section)	
C3H050V4	2.5 / 16mm ²	
	Massive	Multewire
C3H090V4	16 / 50mm ²	25 / 50mm ²
C3H1xxV4	25 / 95mm ²	35 / 95mm ²

The standard connection clamps of Compax3H090V4 and Compax3H1xxV4 are not suitable for flat line bars.

Temperature rating of field installed conductors shall be at least 75°C. Do only use copper lines.

- ◆ Maximum Surrounding Air Temperature: 45°C.
- ◆ Motor overtemperature monitoring is only supported, if the external temperature sensor is connected.
- ◆ Suitable for use on a circuit capable of delivering not more than 18000A symmetrical amperes effectively when protected with fuses as follows:

Device	Protection data
C3H050V4	480 VAC 80 A
C3H090V4	480 VAC 100 A
C3H125V4	480 VAC 160 A
C3H155V4	480 VAC 200 A

Caution!

Risk of electric shock.

Upon removing power to the equipment, please wait at least 10 minutes before accessing the device to ensure internal voltage levels are less than 50VDC.

- ◆ The drive provides internal motor overload protection. This must be set so that 200% of the motor nominal current are not exceeded.
- ◆ Cable cross-sections
 - ◆ Mains input: corresponding to the recommended fuses.
 - ◆ Motor cable: corresponding to the **Nominal output currents** (see on page 352, see on page 353)
 - ◆ This device is provided with Solid State Short Circuit (output) Protection.



1.7.6. Current on the mains PE (leakage current)



Caution!

This product can cause a direct current in the protective lead. If a residual current device (RCD) is used for protection in the event of direct or indirect contact, only a type B (all current sensitive) RCD is permitted on the current supply side of this product. Otherwise, a different protective measure must be taken, such as separation from the environment by doubled or enforced insulation or separation from the mains power supply by means of a transformer.

Please heed the connection instructions of the RCD supplier.

Mains filters do have high leakage currents due to their internal capacity. An internal mains filter is usually integrated into the servo controllers. Additional discharge currents are caused by the capacities of the motor cable and the motor winding. Due to the high clock frequency of the power output stage, the leakage currents do have high-frequency components. Please check if the FI protection switch is suitable for the individual application.

If an external mains filter is used, an additional leakage current will be produced.

The figure of the leakage current depends on the following factors:

- ◆ Length and properties of the motor cable
- ◆ Switching frequency
- ◆ Operation with or without external mains filter
- ◆ Motor cable with or without shield network
- ◆ Motor housing grounding (how and where)

Remark:

- ◆ The leakage current is important with respect to the handling and usage safety of the device.
- ◆ A pulsing leakage current occurs if the supply voltage is switched on.

Please note:

The device must be operated with effective grounding connection, which must comply with the local regulations for high leakage currents (>3.5 mA).

Due to the high leakage currents it is not advisable to operate the servo drive with an earth leakage circuit breaker.

1.7.7. Supply networks

This product is designed for fixed connection to TN networks (TN-C, TN-C-S or TN-S). Please note that the line-earth voltage may not exceed 300VAC.

- ◆ When grounding the neutral conductor, mains voltages of up to 480VAC are permitted.

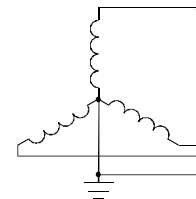

- ◆ When grounding an external conductor (delta mains, two-phase mains), mains voltages (external conductor voltages) of up to 240VAC are permitted.

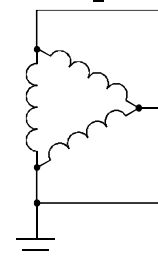

Devices which are to be connected to an IT network must be provided with a separating transformer. Then the devices are operated locally as in a TN network. The secondary sided center of the separating transformer must be grounded and connected to the PE connector of the device.

2. C3I12T11 Function overview

Positioning via I/Os and RS232 / RS485.

Due to its high functionality, the Positioning version of Compax3 forms an ideal basis for many applications in high-performance motion automation.

Up to 31 motion profiles with the motion functions:

- ◆ Absolute or relative positioning,
- ◆ electronic gearbox,
- ◆ register-related positioning,
- ◆ speed control,
- ◆ Stop - Set
- ◆ ...

can be created with the help of the PC software.

The positioning is triggered via the parallel interface (digital interfaces; Option M10 or M12 required) or via RS232 / RS485 / USB.

The signal inputs reg input, limit switch and machine zero proximity switch lie fixed on Compax3 standard inputs.

As a rule there are 2 possible usages:

Access via Compax3 inputs and outputs

The functions are triggered via the Compax3 inputs (standard and optional inputs). Therefore the input/output option M12 resp. M10 (with HEDA) is required.

The status information is sent out via the digital Compax3 outputs (standard and optional outputs).

Access via RS232 / RS485

The functions are triggered via a control word and also in part "by hardware" via the Compax3 inputs (standard inputs).

The status information is sent out via a status word and also in part via the digital Compax3 outputs (standard).

Here the input/output option M12 / M10 is not required for control.

Compax3 control technology

High-performance control technology and openness for various sender systems are fundamental requirements for a fast and high-quality automation of movement.

Model / standards / auxiliary material

The structure and size of the device are of considerable importance. High-quality electronics are a fundamental requirement for the particularly small and compact form of the Compax3 devices. All connectors are located on the front of the Compax3S.

Partly integrated mains filters permit connection of motor cables up to a certain length without requiring additional measures. EMC compatibility is within the limits set by EN 61800-3, Class A. The Compax3 is CE-conform.

The intuitive user interface familiar from many applications, together with the oscilloscope function, wizards and online help, simplifies making and modifying settings via the PC.

The optional **Operator control module (BDM01/01)** (see on page 339) for Compax3S/F makes it possible to exchange devices quickly without requiring a PC.



Configuration Configuration is made with a PC with the help of the Compax3 ServoManager.

3. Compax3 device description

In this chapter you can read about:

Meaning of the status LEDs - Compax3 axis controller	27
Meaning of the status LEDs - PSUP (mains module)	28
Connections of Compax3S	29
Installation instructions Compax3M	38
PSUP/Compax3M Connections	40
Connections of Compax3H	50
Communication interfaces	58
Signal interfaces	60
Mounting and dimensions	66
Safety function - STO (=safe torque off)	75

3.1 Meaning of the status LEDs - Compax3 axis controller

Device status LEDs	Right LED (red)	Left LED (green)
Voltages missing	off	off
During the booting sequence	alternately flashing	
<ul style="list-style-type: none"> ◆ No configuration present. ◆ SinCos® feedback not detected. ◆ Compax3 IEC61131-3 program not compatible with Compax3 Firmware. ◆ no Compax3 IEC61131-3 program ◆ Hall signals invalid. 	flashes slowly	off
Axis powerless	off	flashes slowly
Power supplied to axis; commutation calibration running	off	flashes quickly
Axis powered	off	on
Axis in error state / error present / axis powered (error reaction 1)	flashes quickly	on
Axis in error state / error present / axis not powered (error reaction 2)	on	off
Compax3 faulty: Please contact us	on	on

Note on Compax3H: The **internal** device status LEDs are only connected to the **external** housing LEDs, if the RS232 jumper at X10 is fitted to the control and the upper dummy cover is fitted.

3.2 Meaning of the status LEDs - PSUP (mains module)

PSUP Status LEDs	Left LED (green)	Right LED (red)
Control voltage 24 VDC is missing	off	off
Error of mains module*	off	on
Address assignment CPU active or incorrect wiring	flashes quickly	-
Address assignment CPU completed	flashes slowly	-
Device state: INIT Mains voltage is missing or built up	flashes	flashes quickly
Device state: ERROR One or multiple errors occurred	flashes	on
Device state: RUN	on	off
Device in bootloader state	flashes slowly	flashes slowly

*can be read out in each axis controller



Caution!

When the control voltage is missing there is no indication whether or not high voltage supply is available.

3.3 Connections of Compax3S

In this chapter you can read about:

Compax3S connectors29
 Connector and pin assignment C3S.....30
 Control voltage 24VDC / enable connector X4 C3S32
 Motor / Motor brake C3S connector X3.....33
 Compax3Sxxx V234
 Compax3Sxxx V436

3.3.1. Compax3S connectors



X1	AC Supply	X20	HEDA in (Option M10, M11)	Option M21 inputs
X2	Ballast / DC power voltage	X21	HEDA out (Option M10, M11)	Option M21 inputs
X3	Motor / Brake	X22	Inputs Outputs (Option M10/12)	
X4	24VDC / Enable	X23/ X24	Bus (Option)	Connector type depends on the bus system!
X10	RS232/RS485	S24	Bus settings	
X11	Analog/Encoder	LED1	Device status LEDs	
X12	Inputs/Outputs	LED2	HEDA LEDs	
X13	Motor position feedback	LED3	Bus LEDs	



Caution - Risk of Electric Shock!

Always switch devices off before wiring them!
 Dangerous voltages are still present until 10 min. after switching off the power supply.



Caution!

When the control voltage is missing there is no indication whether or not high voltage supply is available.



Attention - PE connection!

PE connection with 10mm² via a grounding screw at the bottom of the device.



Attention - hot surface!

The heat dissipater can reach very high temperatures (>70°C)

Line cross sections of the line connections X1, X2, X3

Compax3 device:	Cross-section: Minimum... Maximum[mm ²]
S025V2, S063V2	0.25 ... 2.5 (AWG: 24 ... 12)
S100V2, S150V2 S015V4, S038V4, S075V4, S150V4	0.25 ... 4 (AWG: 24 ... 10)
S300V4	0.5 ... 6 (AWG: 20 ... 7)

3.3.2. Connector and pin assignment C3S

Overview:

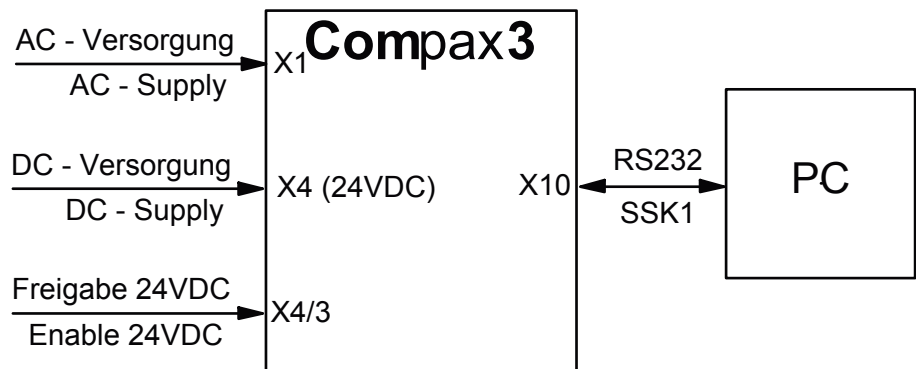

Further information on the assignment of the plug mounted at the particular device can be found below!

In detail: The fitting of the different plugs depends on the extension level of Compax3. In part, the assignment depends on the Compax3 option implemented.

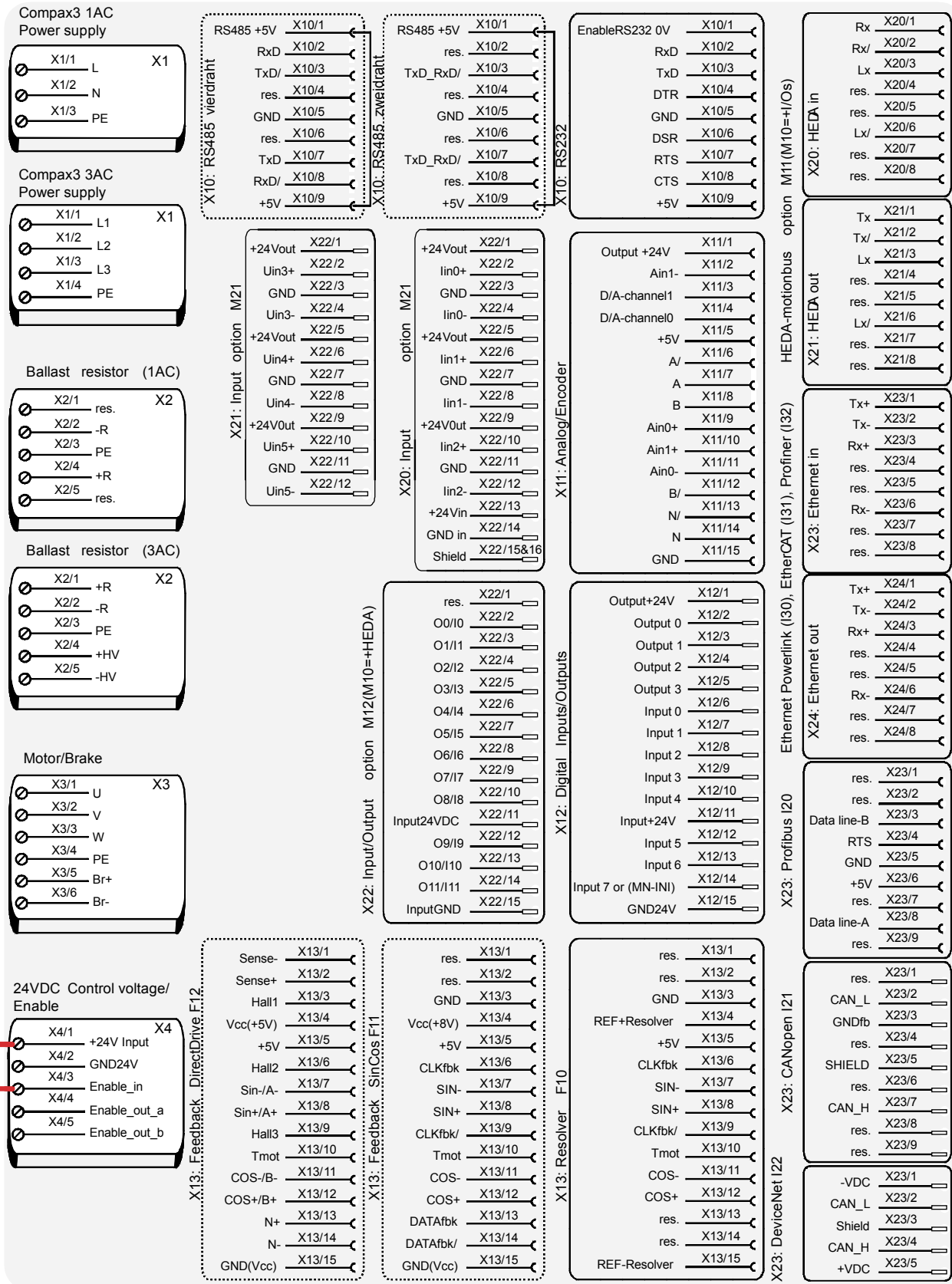

The jumper drawn in at X4 (at the left side in red) is used to enable the device for testing purposes. During operation, the enable input is in most cases switched externally.

3.3.3. Control voltage 24VDC / enable connector X4 C3S

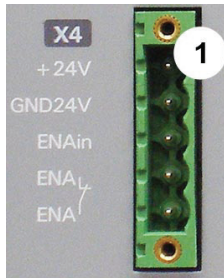

PIN	Description
1	+24V (supply)
2	Gnd24V
3	Enable_in
4	Enable_out_a
5	Enable_out_b

Line cross sections:
 minimum: 0.25mm²
 maximum: 2.5mm²
 (AWG: 24 ... 12)

Control voltage 24VDC Compax3S and Compax3H

Controller type	Compax3
Voltage range	21 - 27VDC
Current drain of the device	0.8 A
Total current drain	0.8 A + Total load of the digital outputs + current for the motor holding brake
Ripple	0.5Vpp
Requirement according to safe extra low voltage (SELV)	yes
Short-circuit proof	conditional (internally protected with 3.15AT)

Hardware - enable (input X4/3 = 24VDC)

This input is used as safety interrupt for the power output stage.

Tolerance range: 18.0V - 33.6V / 720Ω

"Safe torque off (X4/3=0V)

For implementation of the "safety torque off" safety feature in accordance with the "protection against unexpected start-up" described in EN1037. Observe instructions in the corresponding **chapter** (see on page 75) with the circuitry examples!

The energy supply to the drive is reliably shut off, the motor has no torque. A relay contact is located between X4/4 and X4/5 (normally closed contact)

Enable_out_a - Enable_out_b	Power output stage is
Contact opened	activated
Contact closed	disabled

Series connection of these contacts permits certain determination of whether all drives are de-energized.

Relay contact data:

Switching voltage (AC/DC): 100mV - 60V

Switching current: 10mA - 0.3A

Switching power: 1mW...7W

3.3.4. Motor / Motor brake C3S connector X3

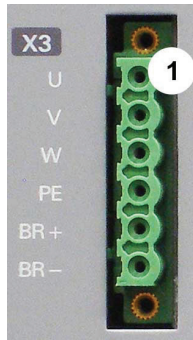

PIN	Designation	Motor cable lead designation*		
1	U (motor)	U / L1 / C / L+	1	U1
2	V (motor)	V / L2	2	V2
3	W (motor)	W / L3 / D / L-	3	W3
4	PE (motor)	YE / GN	YE / GN	YE / GN
5	BR+ Motor holding brake	WH	4	Br1
6	BR- Motor holding brake	BK	5	Br2

* depending on the cable type

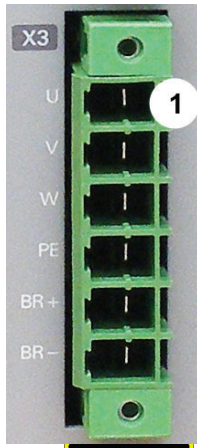

Requirements for motor cable

< 100m (the cable should not be rolled up!)

A **motor output filter** (see on page 317) is required for motor cables >20 m:

Shielding connection of the motor cable

The cable must be fully-screened and connected to the Compax3 housing. Use the cable clamps/shield connecting terminals furnished with the device.

The shield of the cable must also be connected with the motor housing. The fixing (via plug or screw in the terminal box) depends on the motor type.

Attention - Please wire the motor holding brake!

Connect the brake only on motors which have a holding brake! Otherwise make no brake connections at all.

Requirements cables for motor holding brake

If a motor holding brake is present, **one cable** of the motor holding brake must be fed on the device side through the toroidal core ferrite provided as accessory ZBH0x/xx (63Ω @1MHz, di=5.1mm), in order to ensure error-free switching on and off of the motor holding brake.

Motor holding brake output

Motor holding brake output	Compax3
Voltage range	21 – 27VDC
Maximum output current (short circuit proof)	1.6A

Motor cable

3.3.5. Compax3Sxxx V2

In this chapter you can read about:

Main voltage supply C3S connector X134
 Braking resistor / high voltage DC C3S connector X235

3.3.5.1 Main voltage supply C3S connector X1

Device protection

By cyclically switching on and off the power voltage, the input current limitation can be overloaded, which will cause a device error.

Therefore please wait at least 2 minutes after switching off before you switch the device on again!

Power supply plug X1 for 1 AC 230VAC/240VAC devices

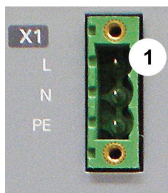

PIN	Designation
1	L
2	N
3	PE

Mains connection Compax3S0xxV2 1AC

Controller type	S025V2	S063V2
Continuous working voltage	Single phase 230VAC/240VAC 80-253VAC / 50-60Hz	
Receiver current consumption	6Arms	13Arms
Maximum fuse rating per device	10 A (automatic circuit breaker K)	16A (automatic circuit breaker K)

* for **UL conform operation** (see on page 20), a miniature circuit breaker, K characteristic, Type S203 is to be used.



Caution - Risk of Electric Shock!

Always switch devices off before wiring them!
 Dangerous voltages are still present until 10 min. after switching off the power supply.

Power supply plug X1 for 3AC 230VAC/240VAC devices

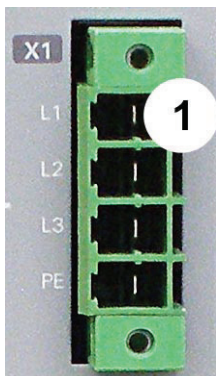

PIN	Designation
1	L1
2	L2
3	L3
4	PE

Mains connection Compax3S1xxV2 3AC

Controller type	S100V2	S150V2
Supply voltage	Three phase 3* 230VAC/240VAC 80-253VAC / 50-60Hz	
Input current	10Arms	13Arms
Maximum fuse rating per device	16A	20A
	MCB miniature circuit breaker, K characteristic	

* for **UL conform operation** (see on page 20), a miniature circuit breaker, K characteristic, Type S203 is to be used.

Caution! The 3AC V2 devices must only be operated with three phases!



Caution - Risk of Electric Shock!

Always switch devices off before wiring them!
 Dangerous voltages are still present until 10 min. after switching off the power supply.

3.3.5.2 Braking resistor / high voltage DC C3S connector X2

The energy generated during braking operation is absorbed by the Compax3 storage capacity.
 If this capacity is too small, the braking energy must be drained via a braking resistor.

Braking resistor / high voltage supply plug X2 for 1AC 230VAC/240VAC devices

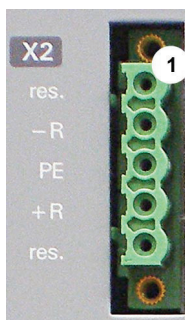

PIN	Designation
1	factory use
2	- braking resistor (not short-circuit protected!)
3	PE
4	+ braking resistor (not short-circuit protected!)
5	factory use

Braking operation Compax3S0xxV2 1AC

Controller type	S025V2	S063V2
Capacitance / storable energy	560µF / 15Ws	1120µF / 30Ws
Minimum braking- resistance	100Ω	56Ω
Recommended nominal power rating	20 ... 60W	60 ... 180W
Maximum continuous current	8A	15A

Caution! The power voltage DC of two Compax3 1AC V2 devices (230VAC/240VAC devices) must not be connected.

Braking resistor / high voltage supply plug X2 for 3AC 230VAC/240VAC devices

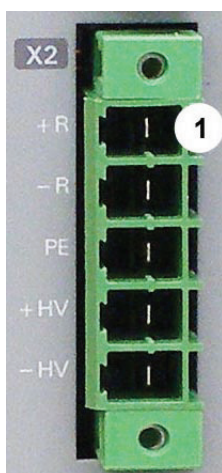

PIN	Description	
1	+ Braking resistor	no short-circuit protection!
2	- Braking resistor	
3	PE	
4	+ DC high voltage supply	
5	- DC high voltage supply	

Braking operation Compax3S1xxV2 3AC

Controller type	S100V2	S150V2
Capacitance / storable energy	780µF / 21Ws	1170µF / 31Ws
Minimum braking- resistance	22Ω	15Ω
Recommended nominal power rating	60 ... 450W	60 ... 600W
Maximum continuous current	20A	20A

Connection of a braking resistor

Minimum line cross section: 1.5mm²
 Maximum line length: 2m
 Maximum output voltage: 400VDC

3.3.6. Compax3Sxxx V4

In this chapter you can read about:

Power supply connector X1 for 3AC 400VAC/480VAC-C3S devices36
 Braking resistor / high voltage supply connector X2 for 3AC 400VAC/480VAC_C3S devices37
 Connection of the power voltage of 2 C3S 3AC devices37

3.3.6.1 Power supply connector X1 for 3AC 400VAC/480VAC-C3S devices

Device protection

By cyclically switching on and off the power voltage, the input current limitation can be overloaded, which will cause a device error.

Therefore please wait at least 2 minutes after switching off before you switch the device on again!

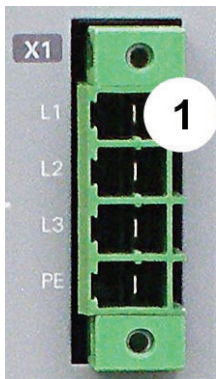

PIN	Designation
1	L1
2	L2
3	L3
4	PE

Mains connection Compax3SxxxV4 3AC

Controller type	S015V4	S038V4	S075V4	S150V4	S300V4
Continuous working voltage	Three phase 3*400VAC/480VAC 80-528VAC / 50-60Hz				
Receiver current consumption	3Aeff	6Arms	10Arms	16Arms	22Arms
Maximum fuse rating per device	6A	10A	16A	20A	25A
	MCB miniature circuit breaker, K characteristic				D*

* for UL conform operation (see on page 20), a miniature circuit breaker, K characteristic, Type S203 is to be used.

Caution!



The 3AC V4 devices must only be operated with three phases!

Caution - Risk of Electric Shock!

Always switch devices off before wiring them!
 Dangerous voltages are still present until 10 min. after switching off the power supply.

3.3.6.2 Braking resistor / high voltage supply connector X2 for 3AC 400VAC/480VAC_C3S devices

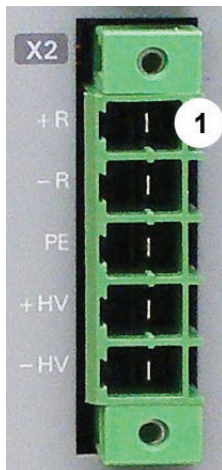

PIN	Description	
1	+ Braking resistor	no short-circuit protection!
2	- Braking resistor	
3	PE	
4	+ DC high voltage supply	
5	- DC high voltage supply	

Braking operation Compax3SxxxV4 3AC

Controller type	S015V4	S038V4	S075V4	S150V4	S300V4
Capacity / storable energy 400V / 480V	235µF 37 / 21 Ws	235µF 37 / 21 Ws	470µF 75 / 42 Ws	690µF 110 / 61 Ws	1230µF 176 / 98 Ws
Minimum ballast - resistance	100 Ω	100 Ω	56 Ω	47 Ω	15 Ω
Recommended nominal power rating	60 ... 100W	60 ... 250W	60 ... 500 W	60 ... 1000 W	60 ... 1000 W
Maximum continuous current	10A	10A	15A	20A	30A

Connection of a braking resistor

Minimum line cross section: 1.5 mm²
 Maximum line length: 2 m
 Maximum output voltage: 800 VDC

3.3.6.3 Connection of the power voltage of 2 C3S 3AC devices

Caution!

The power voltage DC of the single phase Compax3 servo axes must not be connected!

In order to improve the conditions during brake operation, the DC power voltage of 2 servo axes may be connected. The capacity as well as the storable energy are increased; furthermore the braking energy of one servo axis may be utilized by a second servo axis, depending on the application.



It is not permitted to connect the power voltage in order to use one brake circuit for two servo axes, as this function cannot be ensured reliably.

Note the following:

Caution! In case of non-compliance with the following instructions, the device may be destroyed!

- ◆ You can only connect two similar servo axes (same power supply; same rated currents)
- ◆ Connected servo axes must always be fed separately via the AC power supply. If the external pre-fuse of one of the servo axes takes action, the second servo axis must also be disconnected automatically.

Please connect as follows:

Servo axis 1 X2/4 to servo axis 2 X2/4
 Servo axis 1 X2/5 to servo axis 2 X2/5

3.4 Installation instructions Compax3M

General introductory notes

- ◆ Operation of the Compax3M multi-axis combination is only possible in connection with a PSUP (mains module).
- ◆ Axis controllers are aligned at the right of the mains module.
- ◆ Arrangement within the multi-axis combination sorted by power (with the same device types according to device utilization), the axis controller with the highest power is placed directly at the right of the mains module.
e.g. first the device type with high utilization, at the right of this, the same device type with a lower utilization.
- ◆ Max. 15 Compax3M (axis controllers) per PSUP (mains module) are permitted (please respect the total capacity of max. 2400µF for PSUP10, max. 5000µF for PSUP20).
- ◆ The continuation of the current rail connection outside the axis combination is not permitted and will lead to a loss of the CE and UL approbation.
- ◆ External components **may not** be connected to the rail system.

Required tools:

- ◆ Allen key M5 for fixing the devices in the control cabinet.
- ◆ Crosstip screwdriver M4 for connection rails of the DC rail modules.
- ◆ Crosstip screwdriver M5 for grounding screw of the device.
- ◆ Flat-bladed screwdriver 0.4x2.5 / 0.6x3.5 / 1.0x4.0 for wiring and mounting of the phoenix clamps.

Order of installation

- ◆ Fixing the devices in the control cabinet.
 - ◆ Predrilling the mounting plate in the control cabinet according to the specifications. Dimensions. Fit M5 screws loosely in the bores.
 - ◆ Fit device on the upper screws and place on lower screw. Tighten screws of all devices. The tightening torque depends on the screw type (e.g. 5.9Nm for M5 screw DIN 912 8.8).
- ◆ Connection of the internal supply voltage.

The Compax3M axis controllers are connected to the supply voltages via the rail modules. **Details** (see on page 42).

 - ◆ Deblocking the yellow protective cover with a flat-bladed screwdriver on the upper surface (click mechanism). Remove the closing devices (contact protection) that are not required from between the devices.
 - ◆ Connecting the rail modules, beginning with the mains module.

For this, loosen crosshead screws (5 screws at the right in the mains module, all 10 screws in the next axis controller), push the rails one after the other against to the left and tighten screws. Proceed accordingly for all adjacent axis controllers in the combination.

Max. tightening torque: 1.5Nm.
 - ◆ Close all protective covers. The protective covers must latch audibly.

Please note:

Insufficiently fixed screw connections of the DC power voltage rails may lead to the destruction of the devices.

Protective seals



Caution - Risk of Electric Shock!

In order to secure the contact protection against the alive rails, it is absolutely necessary to respect the following:

- ◆ Insert the yellow plastic comb at the left or right of the rails.

Make sure that the yellow plastic combs are placed at the left of the first device and at the right of the last device in the system and have not been removed.
- ◆ Setup of the devices only with closed protective covers.
- ◆ Connect protective earth to mains module (M5 crosshead screw on front of device bottom).
- ◆ Connecting the internal communication. **Details** (see on page 59).
- ◆ Connecting the signal and fieldbus connectors. **Details** (see on page 60).
- ◆ Connection of mains power supply **Details** (see on page 44) ballast resistor **details** (see on page 46) and motor **details** (see on page 48).
- ◆ Connecting the configuration interface to the PC. **Details** (see on page 59).

3.5 PSUP/Compax3M Connections

In this chapter you can read about:

Front connector40
 Connections on the device bottom41
 Connections of the axis combination.....42
 Control voltage 24VDC PSUP (mains module)43
 Mains supply PSUP (mains module) X4144
 Braking resistor / temperature switch PSUP (mains module)46
 Motor / motor brake Compax3M (axis controller)48
 X14 Safety technology option S1 for Compax3M (axis controller)49
 Safety technology option S3 for Compax3M (axis controller)49

3.5.1. Front connector

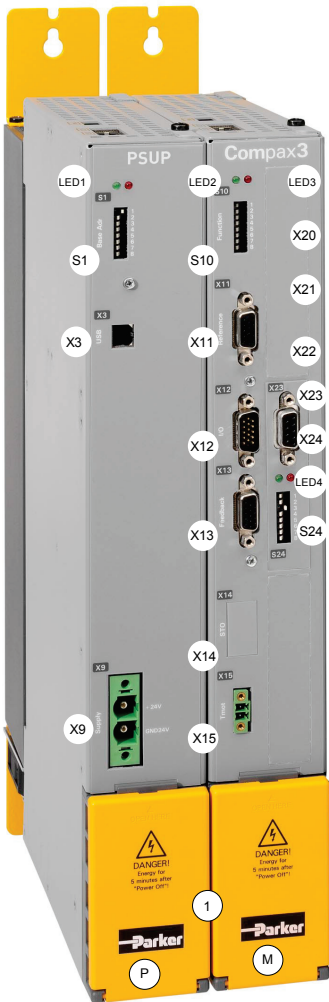

P	PSUP Mains module
LED1	Status LEDs Mains module
S1	Basic address
X3	Configuration interface (USB)
X9	Supply voltage 24VDC
M	Axis controller
LED2	Status LEDs of the axis
S10	Function
X11	Analog/Encoder
X12	Inputs/Outputs
X13	Motor position feedback
X14	Safety technology (Option S1) (replaced by X28 with Option S3)
X15	Motor temperature monitoring
LED3	HEDA LEDs
X20	HEDA in (Option)
X21	HEDA out (Option)
X22	Inputs Outputs (Option M10/12)
X23	Bus (option) connector type depends on the bus system!
X24	Bus (option) depends on the bus system!
LED4	Bus LEDs
S24	Bus settings
1	Behind the yellow protective covers you can find the rails for the supply voltage connection. ♦ Supply voltage 24VDC ♦ DC power voltage supply

3.5.2. Connections on the device bottom



Caution - Risk of Electric Shock!

Always switch devices off before wiring them!
Dangerous voltages are still present until 10 min. after switching off the power supply.



Caution!

When the control voltage is missing there is no indication whether or not high voltage supply is available.



Attention - PE connection!

PE connection with 10mm² via a grounding screw at the bottom of the device.



Attention - hot surface!

The heat dissipater can reach very high temperatures (>70°C)

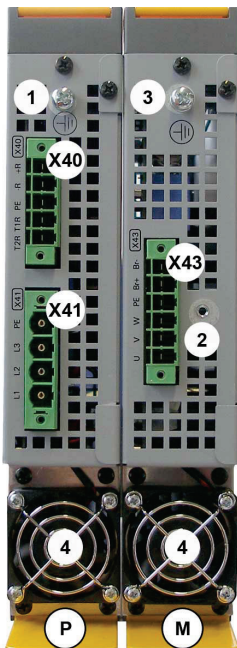

P	Mains module PSUP
X40	Ballast resistor
X41	Mains supply VAC/PE
1	Central ground connection for the axis system, with 10mm ² to the ground screw on the housing.
4	Fan*
M	Axis controller
X43	Motor / Brake
2	Fixing for motor shield clamp
4	Fan*
3	optionally, the axis controller features a ground screw on the housing, if the grounding is not possible via the back plate.

* is internally supplied.

Line cross-sections of the power connections (on the device bottoms)

Compax3 device:	Cross-section: Minimum... Maximum [with conductor sleeve]
M050, M100, M150	0.25 ... 4 mm ² (AWG: 23 ... 11)
M300	0.5 ... 6 mm ² (AWG: 20 ... 10)
PSUP10	Mains supply: 0.5 ... 6 mm ² (AWG: 20 ... 10) Braking resistor: 0.25 ... 4 mm ² (AWG: 23 ... 11)
PSUP20 & PSUP30	Mains supply: 0.5 ... 16 mm ² (AWG: 20 ... 6) Braking resistor: 0.25 ... 4 mm ² (AWG: 23 ... 11)

3.5.3. Connections of the axis combination

The axis controllers are connected to the supply voltages via rails.

- ◆ Supply voltage 24VDC
- ◆ DC power voltage supply

The rails can be found behind the yellow protective covers. In order to connect the rails of the devices, you may have to remove the yellow plastic device inserted at the side.

CAUTION: Risk of Electric Shock



Caution - Risk of Electric Shock!

Please note before opening:

- ◆ **Warning** - Possible risk of electric shock; disconnect power before removing cover.
- ◆ **Caution!** - Dangerous electric voltage! Respect discharge time.



Caution - Risk of Electric Shock!

Always switch devices off before wiring them!

Dangerous voltages are still present until 10 min. after switching off the power supply.



Caution!

When the control voltage is missing there is no indication whether or not high voltage supply is available.

Protective seals



Caution - Risk of Electric Shock!

In order to secure the contact protection against the alive rails, it is absolutely necessary to respect the following:

- ◆ Insert the yellow plastic comb at the left or right of the rails.
Make sure that the yellow plastic combs are placed at the left of the first device and at the right of the last device in the system and have not been removed.
- ◆ Setup of the devices only with closed protective covers.

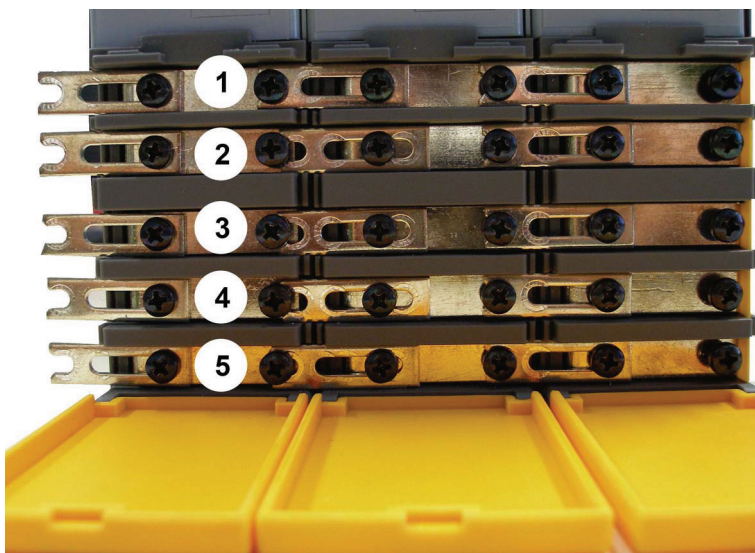

- 1 24VDC
- 2 GND24V
- 3 -HV DC
- 4 PE
- 5 +HV DC

Note: External components **may not** be connected to the rail system.

Maximum capacity in the axis system:

- ◆ PSUP10: 2400 µF
- ◆ PSUP20 & PSUP30: 5000 µF

Reference value for the required capacity in an axis system

100 µF per kW of the temporal medium value of the total power (transmissions + power dissipation) in the axis system.

Example: PSUP20 (1175 µF) with one axis controller (440 µF)

Total power 15 kW, 100 µF/kW => 1500 µF required in the axis system.
Axis system: 1615 µF are sufficient.

Protective seals



Caution!

The user is responsible for protective covers and/or additional safety measures in order to prevent damages to persons and electric accidents.

3.5.4. Control voltage 24VDC PSUP (mains module)

Connector X9

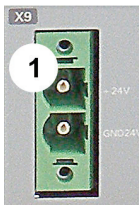

Pin	Designation
1	+24 V
2	GND24V

Line cross sections:
minimum: 0.5mm² with conductor sleeve
maximum: 6mm² with conductor sleeve
(AWG: 20 ... 10)

Control voltage 24 VDC PSUP

Device type	PSUP
Voltage range	21 - 27VDC
Ripple	0.5Vpp
Requirement according to safe extra low voltage (SELV)	yes (class 2 mains module)
Current drain PSUP	PSUP10: 0.2A PSUP20 / PSUP30: 0.3A
Electric current drain Compax3M	C3M050D6: 0.85 3M100D6: 0.85A C3M150D6: 0.85A C3M300D6: 1.0 A + Total load of the digital outputs + current for the motor holding brake

3.5.5. Mains supply PSUP (mains module) X41

Device protection

By cyclically switching on and off the power voltage, the input current limitation can be overloaded, which may cause damage to the device.

Wait at least one minute between two switching on processes!

Operation of the PSUP30 only with mains filter!

Connector X41

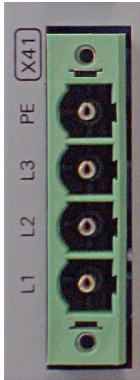

Pin	Designation
PE	Earth conductor
L3	Phase 3
L2	Phase 2
L1	Phase 1

Mains connection PSUP10D6

Device type PSUP10	230V	400V	480V
Supply voltage	230VAC ±10% 50-60Hz	400VAC ±10% 50-60Hz	480VAC ±10% 50-60Hz
Rated voltage	3AC 230V	3AC 400V	3AC 480V
Input current	22Arms	22Arms	18Arms
Output Voltage	325VDC ±10%	565VDC ±10%	680VDC ±10%
Output power	6kW	10 kW	10 kW
Pulse power (<5s)	12kW	20kW	20kW
Heat dissipation	60W	60W	60W
Maximum fuse rating per device	Measure for line and device protection: MCB miniature circuit breaker (K characteristic) 25A in accordance with UL category DIVQ Recommendation: (ABB) S203UP-K25 (480VAC)		

Mains connection PSUP20D6

Device type PSUP20	230V	400V	480V
Supply voltage	230VAC ±10% 50-60Hz	400VAC ±10% 50-60Hz	480VAC ±10% 50-60Hz
Rated voltage	3AC 230V	3AC 400V	3AC 480V
Input current	44Arms	44Arms	35Arms
Output Voltage	325VDC ±10%	565VDC ±10%	680VDC ±10%
Output power	12kW	20kW	20kW
Pulse power (<5s)	24kW	40kW	40kW
Heat dissipation	120W	120W	120W
Maximum fuse rating per device 2 special purpose fuses in line are required	Cable protection measure: MCB (K characteristic) with a rating of 50A / 4xxVAC (depending on the input voltage) Recommendation: (ABB) S203U-K50 (440VAC) Device protection measure: Circuit breakers 80A / 700VAC per supply leg in accordance with UL category JFHR2 Requirement: Bussmann 170M1366 or 170M1566D		

PSUP30D6 Mains connection

Device type PSUP30	230V	400V	480V
Supply voltage	230VAC ±10% 50-60Hz	400VAC ±10% 50-60Hz	480VAC ±10% 50-60Hz
Rated voltage	3AC 230V	3AC 400V	3AC 480V
Input current	50Arms	50Arms	42Arms
Output Voltage	325VDC ±10%	565VDC ±10%	680VDC ±10%
Output power	17kW	30kW	30kW
Pulse power (<5s)	34kW	60kW	60kW
Heat dissipation	140W	140W	140W
Maximum fuse rating per device 2 special purpose fuses in line are required	Cable protection measure: MCB (K characteristic) with a rating of 63A / 4xVAC (depending on the input voltage) Recommendation: (ABB) S203U-K63 (440VAC) Device protection measure: Circuit breakers 125A / 700VAC per supply leg in accordance with UL category JFHR2 Requirement: Bussmann 170M1368 or 170M1568D		

Caution!

Only three-phase operation of the PSUP devices is permitted!

The PSUP30 mains module may only be operated with mains filter (see on page 319)

Required mains filter for the PSUP30: 0.45 mH / 55 A

We offer the following mains filters:

- ◆ LCG-0055-0.45 mH (WxDxH: 180 mm x 140 mm x 157 mm; 10 kg)
- ◆ LCG-0055-0.45 mH-UL (with UL approval) (WxDxH: 180 mm x 170 mm x 157 mm; 15 kg)

Dimensional drawing: LCG-0055-0.45 mH

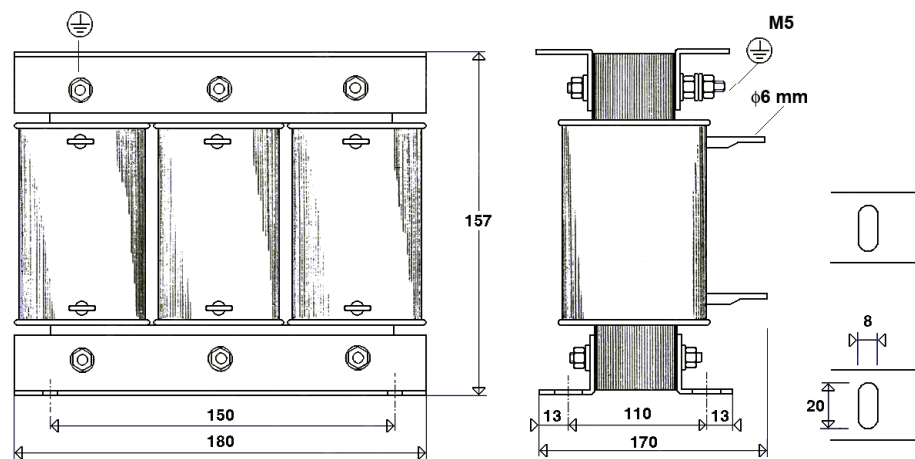

Dimensional drawing: LCG-0055-0.45 mH-UL

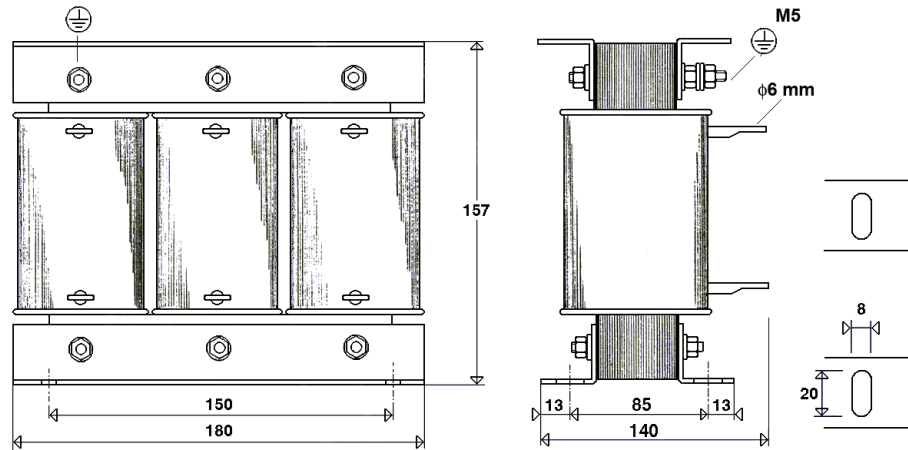

Caution - Risk of Electric Shock!

Always switch devices off before wiring them!
 Dangerous voltages are still present until 10 min. after switching off the power supply.

3.5.6. Braking resistor / temperature switch PSUP (mains module)

The energy generated during braking operation must be dissipated via a braking resistor.

Connector X40

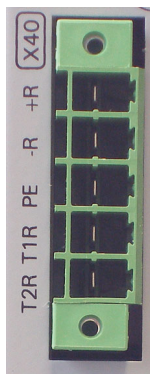

Pin	Description	
+R	+ Braking resistor	short-circuit proof!
-R	- Braking resistor	
PE	PE	
T1R	Temperature Switch	
T2R	Temperature Switch	

Braking operation PSUPxxD6 (mains module)

Device type	PSUP10	PSUP20	PSUP30
Capacitance / storable energy	550 μF/ 92 Ws at 400 V 53 Ws at 480 V	1175 μF/ 197 Ws at 400 V 114 Ws at 480 V	1175 μF/ 197 Ws at 400 V 114 Ws at 480 V
Minimum braking-resistance	27 Ω	15 Ω	10 Ω
Recommended nominal power rating	500 ... 1500 W	500 ... 3500 W	500 ... 5000 W
Pulse power rating for 1s	22 kW	40 kW	60 kW
Maximum permissible continuous current	13 A	15 A	15 A

Maximum capacity in the axis system:

- ◆ PSUP10: 2400 μF
- ◆ PSUP20 & PSUP30: 5000 μF

Reference value for the required capacity in an axis system

100 µF per kW of the temporal medium value of the total power (transmissions + power dissipation) in the axis system.

Example: PSUP20 (1175 µF) with one axis controller (440 µF)

Total power 15 kW, 100 µF/kW => 1500 µF required in the axis system.
Axis system: 1615 µF are sufficient.

Connection of a braking resistor on PSUP (mains module)

Minimum line cross section: 1.5 mm²
Maximum line length: 2 m
Maximum intermediate circuit voltage: 810 VDC
Switch-on threshold: 780 VDC
Hysteresis 20 VDC

Braking operation Compax3MxxxD6 (axis controller)

Device type Compax3	M050	M100	M150	M300
Capacity/ storable energy	110µF/ 18Ws at 400V 10Ws at 480V	220µF/ 37Ws at 400V 21Ws at 480V	220µF/ 37Ws at 400V 21Ws at 480V	440µF/ 74Ws at 400V 42Ws at 480V

3.5.6.1 Temperature switch PSUP (mains module)

Connector X40 Pin T1R, T2R

Temperature monitoring:

The temperature switch (normally closed contact) must be connected, unless an error message will be issued.

Temperature switch/relay

No galvanic separation, the temperature sensor (normally closed contact) must comply with the safe separation according to EN 60664.

If there is no temperature monitoring due to the connected braking resistor, the T1R and T2R connections must be connected by a jumper.



Caution!

Without temperature monitoring, the braking resistor might be destroyed.

3.5.7. Motor / motor brake Compax3M (axis controller)

Connector X43



Compax3M motor cable

PIN	Designation	Motor cable lead designation*		
BR-	Motor holding brake *	BK	5	Br2
BR+	Motor holding brake *	WH	4	Br1
PE	PE (motor)	YE / GN	YE / GN	YE / GN
W	W (motor)	W / L3 / D / L-	3	U3
V	V (motor)	V / L2	2	U2
U	U (motor)	U / L1 / C / L+	1	U1

* depending on the cable type

<80m per axis (the cable must not be rolled up!)

The entire length of the motor cable per axis combination may not exceed 300m. A **motor output filter** (see on page 317) is required for motor cables >20 m:

- ◆MDR01/04 (max. 6.3 A rated motor current)
- ◆MDR01/01 (max. 16 A rated motor current)
- ◆MDR01/02 (max. 30 A rated motor current)

Shielding connection of the motor cable

The cable must be fully-screened and connected to the Compax3 housing. Use the cable clamps/shield connecting terminals furnished with the device.

The shield of the cable must also be connected with the motor housing. The fixing (via plug or screw in the terminal box) depends on the motor type.



Motor cables can be found in the accessories chapter of the device description.

Motor holding brake output

Motor holding brake output	Compax3
Voltage range	21 – 27VDC
Maximum output current (short circuit proof)	1.6A



Attention - Please wire the motor holding brake!

Connect the brake only on motors which have a holding brake! Otherwise make no brake connections at all.

Requirements cables for motor holding brake

If a motor holding brake is present, **one cable** of the motor holding brake must be fed on the device side through the toroidal core ferrite provided as accessory ZBH0x/xx (63Ω @1MHz, di=5.1mm), in order to ensure error-free switching on and off of the motor holding brake.

3.5.7.1 Measurement of the motor temperature of Compax3M (axis controller)

Connector X15

The acquisition of the motor temperature by the axis controller can either take place via the connection of X15 (Tmot) or via the feedback cable and the corresponding connection on X13 PIN10.



Pin	Description
1	+5V
2	Sensor

The temperature acquisition on X15 Tmot can not be connected at the same time as X13 Pin 10.

3.5.8. X14 Safety technology option S1 for Compax3M (axis controller)

Connector X14 (Not available with Safety option S3)



Pin	Description	
1	STO1/	+24VDC
2	STO-GND	GND
3	STO2/	+24VDC
4	STO-GND	GND



Note!

If the Compax3M axis controller features a safety option, these connections must also be wired, otherwise it is not possible to set up the axis.

3.5.9. Safety technology option S3 for Compax3M (axis controller)

For a description of the S3 safety option, please refer to the following manuals:

- ◆ 192-120210 Installation Manual Safety Option S3 for Compax3M
- ◆ 192-120211 Programming Manual Safety Option S3 for Compax3M
- ◆ 192-120212 Description of the Standard I/O Profile R0110001xx for Option S3 (Compax3M)

These manuals can be found on the Compax3 DVD in the ""Safety_Option_S3"" folder.

3.6 Connections of Compax3H

In this chapter you can read about:

Compax3H plugs/connections	50
Connection of the power voltage.....	51
Compax3H connections front plate	52
Plug and pin assignment C3H	53
Motor / Motor brake C3H	55
Control voltage 24 VDC C3H	56
Mains connection Compax3H	56
Braking resistor / supply voltage C3H	57

3.6.1. Compax3H plugs/connections

The following figure is an example for all sizes.
The fitting of the different controller plugs depends on the extension level of Compax3.

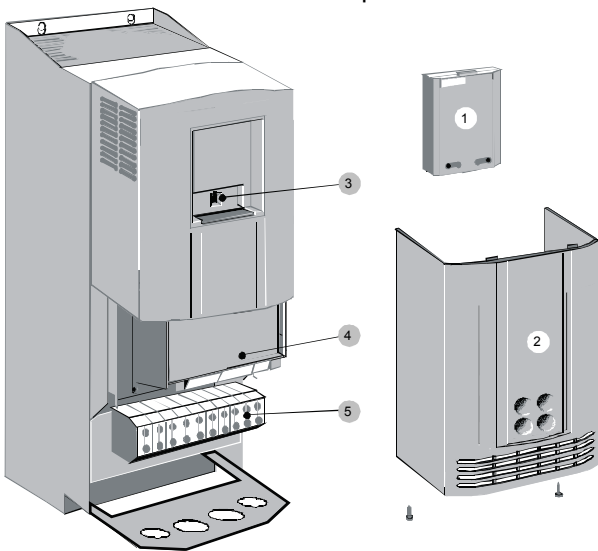

- (1): Dummy cover with display of the **external** device status LEDs.
- (2): lower clamp cover, fixed by 2 screws at the device bottom.
- (3): RS232 programming interface
Connection to the PC via adapter cable SSK32/20 (furnished with the device) and standard RS232 cable SSK1.
- (4): Control
- (5): Power connections



Always switch devices off before wiring them!

Dangerous voltages are still present until 5 minutes after switching off the power supply!



Caution!

If the control voltage is missing and if the X10-X10 jumper is not fitted (VBK17/01) on the control part, the availability of power voltage is not displayed.



PE connection

PE connection with 10mm² via a grounding screw at the bottom of the device.



Attention hot surface!

Metal parts can heat up to a temperature of 90°C during operation.

3.6.2. Connection of the power voltage

The terminal block of the drive can be found under the front cover. It is secured with 2 screws at the bottom of the device. Remove the bottom cover in order to access the connection clamps.
 Make sure that all live parts are covered by the housing after installation.

Illustration of the connection clamps exemplarily for all sizes:

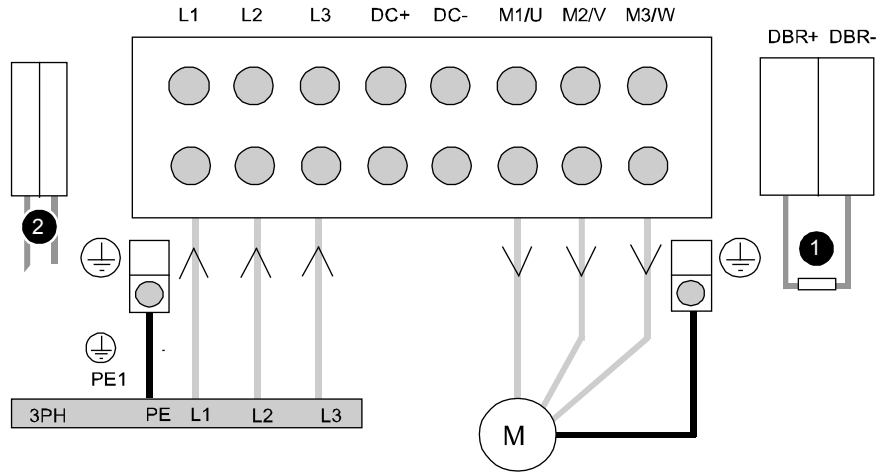

L1, L2, L3: 3 phase mains connection
 M1, M2, M3: Motor connections
 DC+, DC-: DC link voltage
 (1) DBR+ and DBR-: Connection of external braking resistor
 (2) AUX1, AUX2: only with C3H1xxV4 external supply (AC) for device ventilator L, N

- ◆ All shields must be connected via a cable joint to the cable feed through plate.
- ◆ Braking resistor and cable must be shielded if they are not installed in a control cabinet.
- ◆ The standard connection clamps of C3H090V4 and C3H1xxV4 are **not** suitable for flat line bars.

Attention: The MOT/TEMP connection is not supported by the Compax3H050; do therefore not wire this connection!

Terminal clamps - max. line cross sections

The line cross sections must correspond to the locally valid safety regulations. The local regulations have always priority.

	Power clamps (minimum/maximum section)	
C3H050V4	2.5 / 16mm ²	
	Massive	Multiwire
C3H090V4	16 / 50mm ²	25 / 50mm ²
C3H1xxV4	25 / 95mm ²	35 / 95mm ²

The standard connection clamps of Compax3H090V4 and Compax3H1xxV4 are not suitable for flat line bars.

Cover plate for cable feed through

The cable feed through holes have the following dimensions:	
C3H050V4	28.6mm for M20, PG16 and 1/2" NPT (America). 37.3mm for M32, PG29 and 1" NPT (America).
C3H090V4	22.8mm for M20, PG16 and 1/2" NPT (America). 28.6mm for M25, PG21 and 3/4" NPT (America). 47.3mm for M40, PG36 and 1 1/4" NPT (America). 54.3mm for M50, PG42 and 1 1/2" NPT (America).
C3H1xxV4	22.8mm for M20, PG16 and 1/2" NPT (America) 28.6mm for M25, PG21 and 3/4" NPT (America)

Recommended tightening torques

	High voltage supply	Ballast resistor	Grounding
C3H050V4	4Nm / 35lb-in	4Nm / 35lb-in	4.5Nm / 40lb-in
C3H090V4	6-8Nm / 53-70lb-in	6-8Nm / 53-70lb-in	6-8Nm / 53-70lb-in
C3H1xxV4	15-20Nm / 132-177lb-in	0.7Nm / 6.1lb-in	42Nm / 375lb-in

cable glands

Use metallic cable joints permitting a 360° shielding in order to comply with the EMC directive.

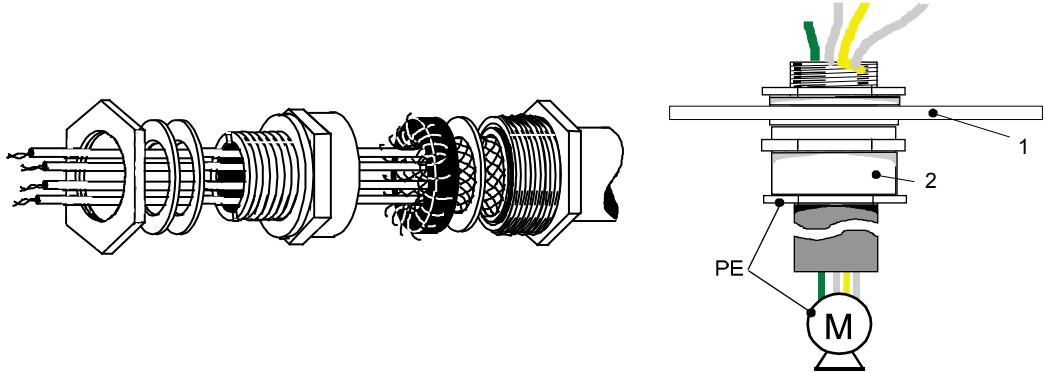

1: Cable feed through plate

2: metallic joint with 360° shielding for EMC compliant design

The device must be grounded without interruption according to EN 61800-5-1. The mains supply lines must be protected with a suitable fuse or a circuit breaker (FI switches or earth fault fuses are not recommended).

For installation in accordance with EN 61800-5-1 mm Europe:

- ◆ For grounding without interruption, two separate protective leads (2 cross-section) or one lead ($>10\text{mm}^2$ cross-section) are required. Each protective lead must meet the requirements according to EN 60204.

3.6.3. Compax3H connections front plate

Communication and signal interfaces

Showcase front plate of the control (number of connectors depends on the extension level of the Compax3)

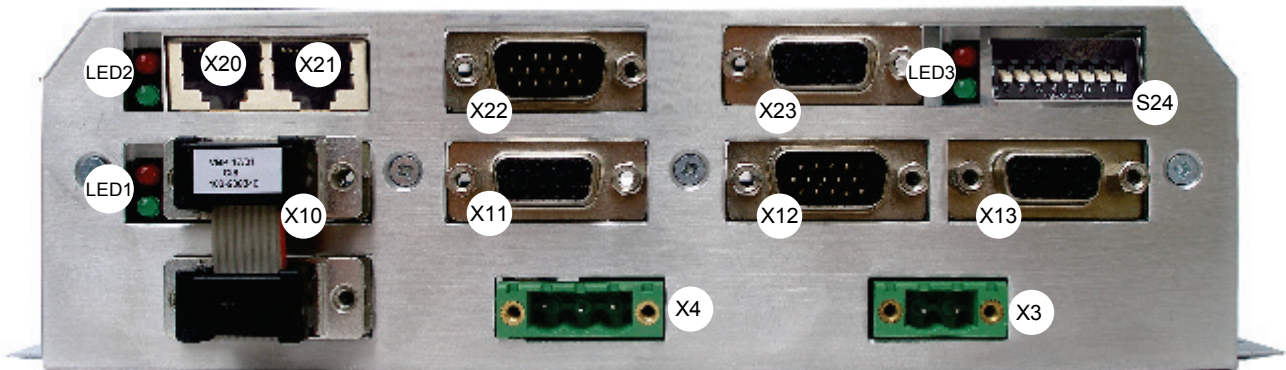

X3	Motor brake	X20	HEDA in (Option)	
X4	24VDC	X21	HEDA out (Option)	
X10	RS232/RS485 with jumper to the programming interface	X22	Inputs Outputs (Option M10/12)	
X11	Analog/Encoder	X23	Bus (Option)	Connector type depends on the bus system!
X12	Inputs/Outputs	S24	Bus settings	
X13	Motor position feedback	LED1	Device status LEDs	
		LED2	HEDA LEDs	
		LED3	Bus LEDs	

Note on Compax3H: The **internal** device status LEDs are only connected to the **external** housing LEDs, if the RS232 jumper at X10 is fitted to the control and the upper dummy cover is fitted.
The RS232 programming interface under the upper dummy cover is only available if the X10 jumper at the controller is fitted.

3.6.4. Plug and pin assignment C3H

Overview

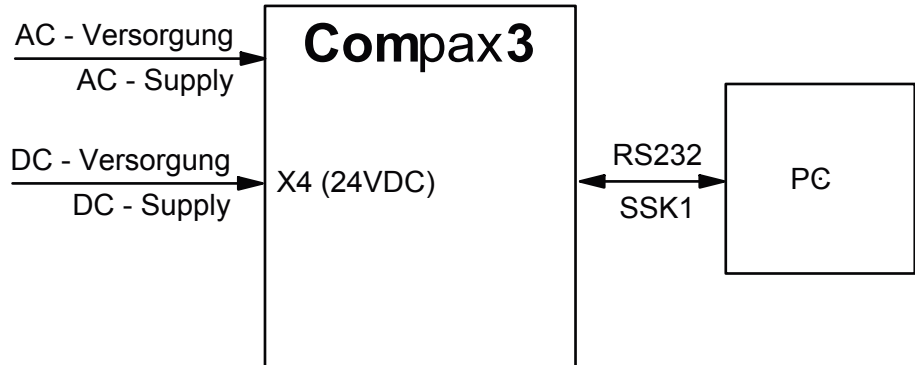

Further information on the assignment of the plug mounted at the particular device can be found below!

In detail: The fitting of the different plugs depends on the extension level of Compax3. In part, the assignment depends on the Compax3 option implemented.

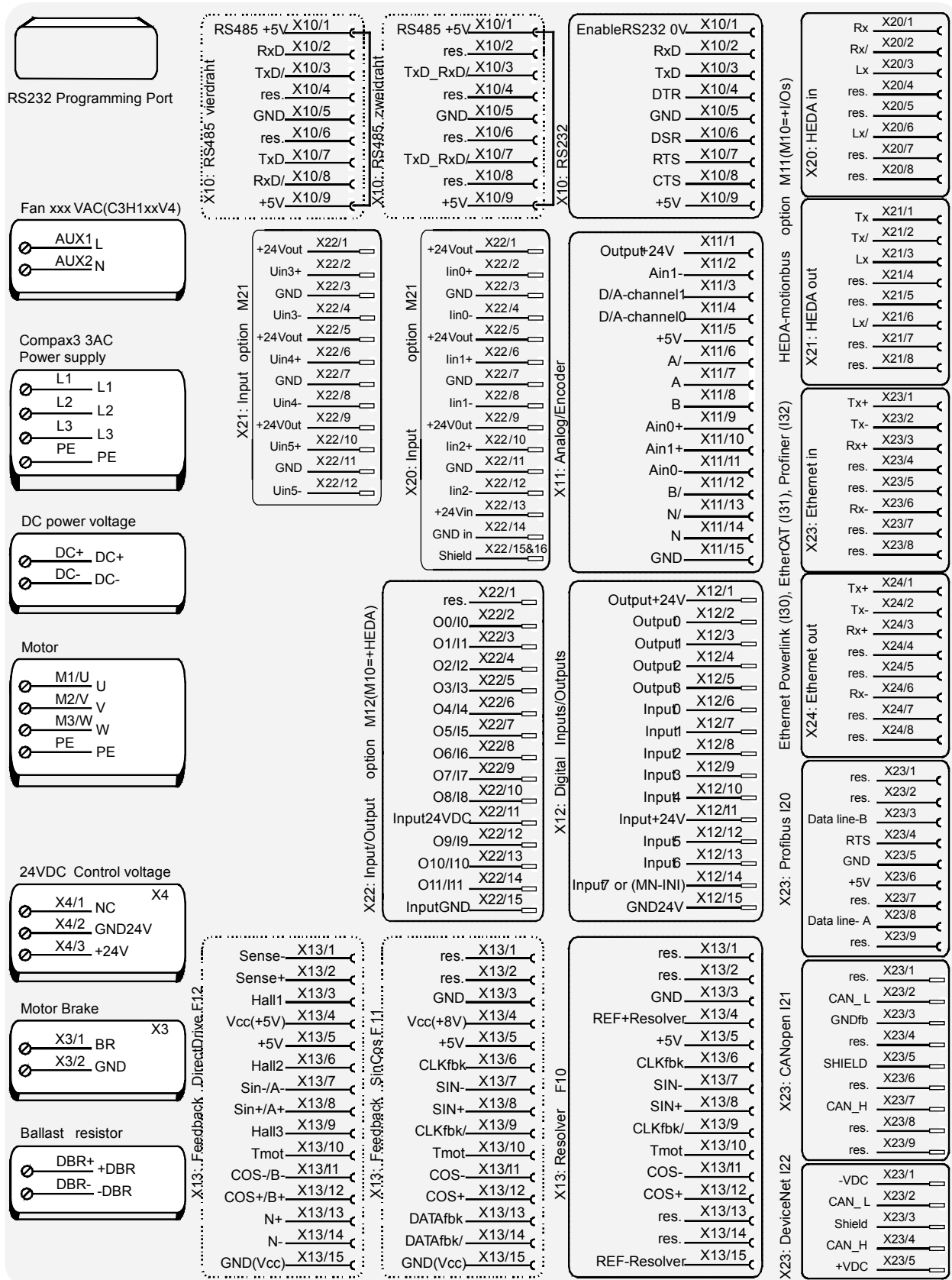

The RS232 programming interface under the upper dummy cover is only available if the X10 jumper at the controller is fitted.

Please note

C3H1xxV4 uses a ventilator fan which must be externally supplied via separate connections. The ventilator fan is available in two versions for single phase feed: 220/240VAC; 110/120VAC

3.6.5. Motor / Motor brake C3H

Compax3H motor cable

A motor output filter is required for motor cables >50m. Please contact us.

Shielding connection of the motor cable

The motor cable should be fully shielded and connected to the Compax3 housing.

The shield of the motor cable must also be connected with the motor housing. The fixing (via plug or screw in the terminal box) depends on the motor type. Motor connection clamps figure (see on page 51)

PIN	Designation	Motor cable lead designation*		
M1/U	U (motor)	U / L1 / C / L+	1	U1
M2/V	V (motor)	V / L2	2	U2
M3/W	W (motor)	W / L3 / D / L-	3	U3
PE	PE (motor)	YE / GN	YE / GN	YE / GN

* depending on the cable type

Compax3H motor cable

A motor output filter is required for motor cables >50m. Please contact us.

Shielding connection of the motor cable

The motor cable should be fully shielded and connected to the Compax3 housing. The shield of the motor cable must also be connected with the motor housing. The fixing (via plug or screw in the terminal box) depends on the motor type.



Attention - Please wire the motor holding brake!

Connect the brake only on motors which have a holding brake! Otherwise make no brake connections at all.

Requirements cables for motor holding brake

If a motor holding brake is present, **one cable** of the motor holding brake must be fed on the device side through the toroidal core ferrite provided as accessory ZBH0x/xx (63Ω @1MHz, di=5.1mm), in order to ensure error-free switching on and off of the motor holding brake.

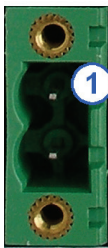

Connection of motor brake X3 figure (see on page 52)

PIN	Designation	Motor cable lead designation*		
1	BR	WH	4	Br1
2	GND	BK	5	Br2

Motor holding brake output

Motor holding brake output	Compax3
Voltage range	21 – 27VDC
Maximum output current (short circuit proof)	1.6A

3.6.6. Control voltage 24 VDC C3H



Connection of control voltage 24VDC figure (see on page 52)

Connector X4 Pin	Description	
1	NC	NC
2	GND24V	GND
3	+24 V	24 VDC (power supply)

Control voltage 24VDC Compax3S and Compax3H

Controller type	Compax3
Voltage range	21 - 27VDC
Current drain of the device	0.8 A
Total current drain	0.8 A + Total load of the digital outputs + current for the motor holding brake
Ripple	0.5Vpp
Requirement according to safe extra low voltage (SELV)	yes
Short-circuit proof	conditional (internally protected with 3.15AT)

3.6.7. Mains connection Compax3H

Device protection

Avoid permanent switching on and off so that the charging connection is not overloaded. Therefore wait at least 1 minute before switching on the device again.

Connection of mains voltage figure (see on page 51)

Mains connection Compax3HxxxV4 3*400VAC

Device type Compax3	H050V4	H090V4	H125V4	H155V4
Continuous working voltage	Three-phase 3*400VAC 350-528VAC / 50-60Hz			
Receiver current consumption	66Arms	95Arms	143Arms	164Arms
Output current	50Arms	90Arms	125Arms	155Arms
Maximum input fuse rating per device	80A	100A	160A	200A
Recommended line protection in accordance with UL	JDDZ Class K5 or H JDRX Class H			

Mains connection Compax3HxxxV4 3*480VAC

Device type Compax3	H050V4	H090V4	H125V4	H155V4
Continuous working voltage	Three-phase 3*480VAC 350-528VAC / 50-60Hz			
Receiver current consumption	54Arms	82Arms	118Arms	140Arms
Output current	43Arms	85Arms	110Arms	132Arms
Maximum input fuse rating per device	80A	100A	160A	200A
Recommended line protection in accordance with UL	JDDZ Class K5 or H JDRX Class H			

3.6.8. Braking resistor / supply voltage C3H

The energy generated during braking operation is absorbed by the Compax3 storage capacity.

If this capacity is too small, the braking energy must be drained via a braking resistor.

3.6.8.1 Connect braking resistor C3H

Connection of braking resistor figure (see on page 51)

PIN	Designation
DBR+	+ Braking resistor
DBR-	- Braking resistor

Braking operation of Compax3HxxxV4

Controller type	H050V4	H090V4	H125V4	H155V4
Capacitance / storable energy 400V / 480V	2600 μ F 602 / 419 Ws	3150 μ F 729 / 507 Ws	5000 μ F 1158 / 806 Ws	5000 μ F 1158 / 806 Ws
Minimum braking- resistance	24 Ω	15 Ω	8 Ω	8 Ω
Maximum continuous current	11 A	17 A	31 A	31 A

Minimum line cross section: 2.5mm²
 Maximum line length: 2m
 Maximum output voltage: 830VDC

3.6.8.2 Power supply voltage DC C3H

Connection of power voltage DC -figure (see on page 51)

PIN	Description
DC+	+ DC high voltage supply
DC-	- DC high voltage supply



Warning!

Do not connect any braking resistor on DC+/DC- .

3.6.8.3 Connection of the power voltage of 2 C3H 3AC devices

In order to improve the conditions during brake operation, the DC power voltage of 2 servo axes may be connected.

The capacity as well as the storable energy are increased; furthermore the braking energy of one servo axis may be utilized by a second servo axis, depending on the application.



It is not permitted to connect the power voltage in order to use one brake circuit for two servo axes, as this function cannot be ensured reliably.

Note the following:

Caution! In case of non-compliance with the following instructions, the device may be destroyed!

- ◆ You can only connect two similar servo axes (same power supply; same rated currents)
- ◆ Connected servo axes must always be fed separately via the AC power supply.
- ◆ If the external pre-fuse of one of the servo axes takes action, the second servo axis must also be disconnected automatically.

Please connect as follows:

Servo axis 1 DC+ with servo axis 2 DC+

Servo axis 1 DC- with servo axis 2 DC-

- figure (see on page 51)

3.7 Communication interfaces

In this chapter you can read about:

RS232 / RS485 interface (plug X10).....58
 Communication Compax3M.....59

3.7.1. RS232 / RS485 interface (plug X10)

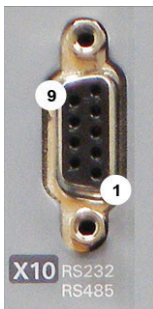

Interface selectable by contact functions assignment of X10/1:

X10/1=0V RS232

X10/1=5V RS485

PIN X10	RS232 (Sub D)
1	(Enable RS232) 0V
2	RxD
3	TxD
4	DTR
5	GND
6	DSR
7	RTS
8	CTS
9	+5V
PIN X10	RS485 two wire (Sub D) Pin 1 and 9 jumpered externally
1	Enable RS485 (+5V)
2	res.
3	TxD_RxD/
4	res.
5	GND
6	res.
7	TxD_RxD
8	res.
9	+5V
PIN X10	RS485 four wire (Sub D) Pin 1 and 9 externally jumpered
1	Enable RS485 (+5V)
2	RxD
3	TxD/
4	res.
5	GND
6	res.
7	TxD
8	RxD/
9	+5V

USB - RS232/RS485 converter

The following USB - RS232 converters were tested:

- ◆ ATEN UC 232A
- ◆ USB GMUS-03 (available under several company names)
- ◆ USB / RS485: Moxa Uport 1130
http://www.moxa.com/product/UPort_1130_1130I.htm
- ◆ Ethernet/RS232/RS485: NetCom 113 <http://www.vscom.de/666.htm>
- ◆ Exsys Adapter USB to RS232 with FTDI processor (Windows 7)

3.7.2. Communication Compax3M

In this chapter you can read about:

PC - PSUP (Mains module)59
 Communication in the axis combination (connector X30, X31).....59
 Adjusting the basic address60
 Setting the axis function.....60

3.7.2.1 PC - PSUP (Mains module)

Connector X3

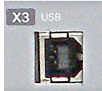

USB2.0

Connect your PC to the USB sleeve X3 of the mains module via an USB cable (SSK33/03).

3.7.2.2 Communication in the axis combination (connector X30, X31)

The communication in the axis combination is implemented via a SSK28 cable and double RJ45 sleeves on the device top.

Beginning with the PSUP (mains module) the connection is always made from X30 to X31 of the next device. On the first device (X31) and the last device (X30) in the multi-axis combination, a bus termination plug (**BUS07/01** (see on page 349)) is required.

Orientation to the back side

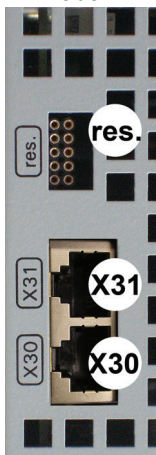

Orientation to the front plate

	PSUP (Mains module)
X30	out
X31	in
res.	factory use
	Compax3M (axis)
X30	out
X31	in
res.	factory use

3.7.2.3 Adjusting the basic address

On the mains module, the basic address of the device combination is set in steps of 16 with the aid of the first three dip switches.

The mains module contains the set basic address while the axes placed at the right in the combination contain the following addresses.

Switch S1

Address setting

Basic addresses

Switch	Value upon ON
1	16
2	32
3	64

Settings:

left: OFF

right: ON

Settable value range: 0, 16, 32, 48, 64, 80, 96, 112

Address of the 1st axis = basic address+1

The addresses of the axis controllers are newly assigned after PowerOn.

Example:

Basic address = 48; mains module with 6 axis controllers in the combination

1. Axis right: Address = 49

2. Axis right: Address = 50

...

6. Axis right: Address = 54



3.7.2.4 Setting the axis function

Switch S10

Function settings for T30 and T40

The value of switch S10 on the axis controller is stored in object O110.1

C3plus.Switch_DeviceFunction and can be evaluated with the aid of a program.

This helps realize a more simple function selection.



3.8 Signal interfaces

In this chapter you can read about:

Resolver / Feedback (connector X13).....61
 Analogue / encoder (plug X11)63
 Digital inputs/outputs (plug X12)64

3.8.1. Resolver / Feedback (connector X13)

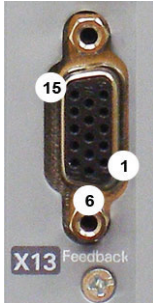

Assignment with feedback F10 (Resolver)

PIN X13	Feedback /X13 High Density /Sub D
	Resolver (F10)
1	factory use
2	factory use
3	GND
4	REF-Resolver+
5	+5V (for temperature sensor)
6	factory use
7	SIN-
8	SIN+
9	factory use
10	Tmot*
11	COS-
12	COS+
13	factory use
14	factory use
15	REF-Resolver-

Assignment with feedback F11 (SinCos)

PIN X13	Feedback /X13 High Density /Sub D
	SinCos (F11)
1	factory use
2	factory use
3	GND
4	Vcc (+8V with Compax3S & Compax3H; +10 V with Compax3M)
5	res+5 V (for temperature sensor)
6	factory use
7	SIN-
8	SIN+
9	factory use
10	Tmot*
11	COS-
12	COS+
13	DATAfbk
14	DATAfbk/
15	GND (Vcc)

Assignment with feedback F12 (EnDat)

PIN X13	Feedback /X13 High Density /Sub D		
	EnDat 2.1 & 2.2 with incremental track (Endat01, Endat02)	EnDat 2.1 fully digital (Endat21) (cable length max. 90 m)	EnDat 2.2 fully digital (Endat02, Endat22) (cable length max. 25 m)
1	Sense -*		factory use
2	Sense +*		factory use
3	factory use		
4	Vcc (+5 V) * max. 350 mA load		
5	+5 V (for temperature sensor)		
6	CLKfbk		
7	SIN- / A- (Encoder)	factory use	
8	SIN+ / A+ (Encoder)	factory use	
9	CLKfbk/		
10	Tmot*		
11	COS- / B- (Encoder)	factory use	
12	COS+ / B+ (Encoder)	factory use	
13	DATAfbk		
14	DATAfbk/		
15	GND (Vcc)		

*X13 Pin10 Tmot may not be connected at the same time as X15 (on Compaxx3M).

Resolver cables (see on page 321) can be found in the accessories chapter of the device description.

SinCos® cables (see on page 322) can be found in the accessories chapter of the device description.

EnDat - cable GBK38 (EnDat2.1) and GBK56 (EnDat2.2) (see on page 305, see on page 322)

Incremental Feedback (optionally with hall sensors)

PIN X13	Feedback option F12 / X13 High Density /Sub D
1	Sense -*
2	Sense +*
3	Hall1 (digital)
4	Vcc (+5V)* max. 350 mA load
5	+5 V (for temperature sensors and Hall sensors)
6	Hall2 (digital)
7	SIN-, A- (Encoder) or analog Hall sensor
8	SIN+, A+, (Encoder) or analog Hall sensor
9	Hall3 (digital)
10	Tmot*
11	COS-, B- (Encoder) or analog Hall sensor
12	COS+, B+ (Encoder) or analog Hall sensor
13	N+
14	N-
15	GND (Vcc)

*X13 Pin10 Tmot may not be connected at the same time as X15 (on Compaxx3M).

Note on F12:

*+5V (Pin 4) is measured and controlled directly at the end of the line via Sense+ and Sense-.

Cable length max.: 100m

Caution!

- ◆ Pin 4 and Pin 5 must under no circumstances be connected!
- ◆ Plug in or pull out feedback connector only in switched off state (24VDC switched off).

3.8.2. Analogue / encoder (plug X11)

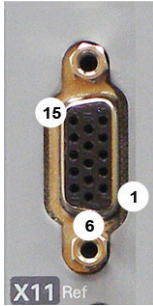

PIN X11	Reference High Density Sub D		
		Encoders	SSI
1	+24V (output) max. 70mA		
2	Ain1 -; analog input - (14Bits; max. +/-10V)		
3	D/A monitor channel 1 (±10V, 8-bit resolution)		
4	D/A monitor channel 0 (±10V, 8-bit resolution)		
5	+5 V (output for encoder) max. 150 mA		
6	- Input: steps RS422 (5V - level)	A/ (Input / -simulation)	Clock-
7	+ Input: steps RS422 (5V - level)	A/ (Input / -simulation)	Clock+
8	+ Input: direction RS422 (5V - level)	B Input / -simulation)	
9	Ain0 +: analog input + (14Bits; max. +/-10V)		
10	Ain1 +: analog input + (14Bits; max. +/-10V)		
11	Ain0 -: analog input- (14Bits; max. +/-10V)		
12	- Input: direction RS422 (5V - level)	B/ input / -simulation)	
13	factory use	N/ input / -simulation)	DATA-
14	factory use	N input / -simulation)	DATA+
15	GND		

Technical Data X11 (see on page 358)

3.8.2.1 Wiring of analog interfaces

Output

Input

Compax3

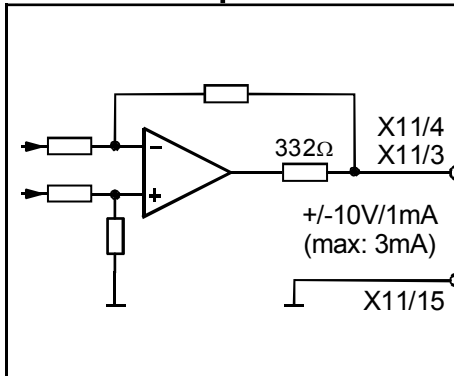

Compax3

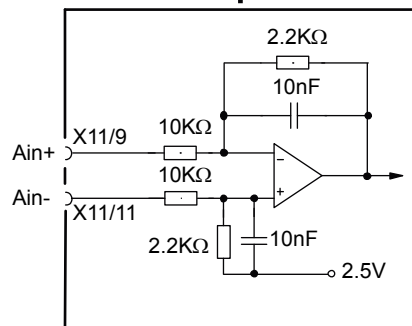

Perform an **offset adjustment** (see on page 231)!

Structure image of the **internal signal processing of the analog inputs**, Ain1 (X11/10 and X11/2) has the same wiring!

3.8.2.2 Connections of the encoder interface

Compax3

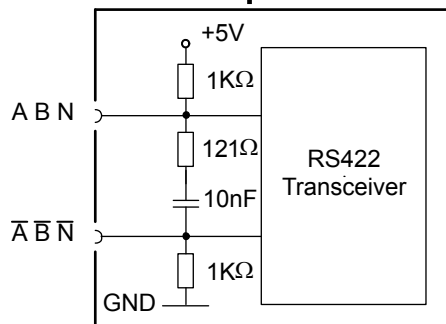

The input connection is available in triple (for A & /A, B & /B, N & /N)

3.8.3. Digital inputs/outputs (plug X12)

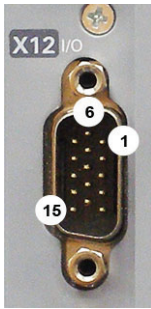

Pin X12	Input / Output	High density/Sub D	
1	O	+24 V DC output (max. 400mA)	
2	O0	No error	Only for "fixed assignment" Functions are available, if "Fixed assignment" was selected for the I/O assignment in the configuration wizard
3	O1	Position / speed / gear synchronization attained (max. 100 mA)	
4	O2	Power stage without current (max. 100mA)	
5	O3	Axis energized with a setpoint of 0 (max. 100 mA)	
6	I0="1":	Quit (positive edge) / activate the axis	
	I0="0"	Axis disable with delay	
7	I1	no Stop	
8	I2	JOG +	
9	I3	JOG -	
10	I4	Reg input	
11	I	24V input for the digital outputs Pins 2 to 5	
12	I5	Limit switch 1	
13	I6	Limit switch 2	
14	I7	Machine zero initiator	
15	O	GND24V	

All inputs and outputs have 24V level.

Maximum capacitive loading of the outputs: 30nF (max. 2 Compax3 inputs can be connected)

Input-/Output extension (see on page 129)

Optimization window display

The display of the digital inputs in the optimization window of the C3 ServoManager does not correspond to the physical status (24Volt=on, 0Volt=off) but to the logic status: if the function of an input or output is inverted (e.g. limit switch, negatively switching), the corresponding display (LED symbol in the optimization window) is OFF with 24Volts at the input and ON with 0 Volts at the input.

In operation via RS232 / RS485 the inputs I0 ... I3 as well as the outputs O0 ... O3 can be freely assigned as an option.

Configurable via the C3 ServoManager (configuration: Operating mode / I/O assignment)

3.8.3.1 Connection of the digital Outputs/Inputs

Wiring of digital outputs

Compax3

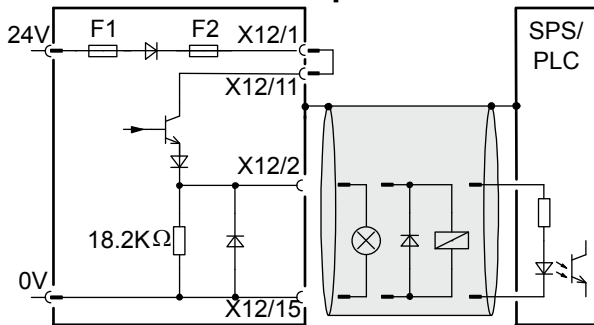

The circuit example is valid for all digital outputs!
The outputs are short circuit proof; a short circuit generates an error.

Status of digital inputs

SPS/PLC

Compax3

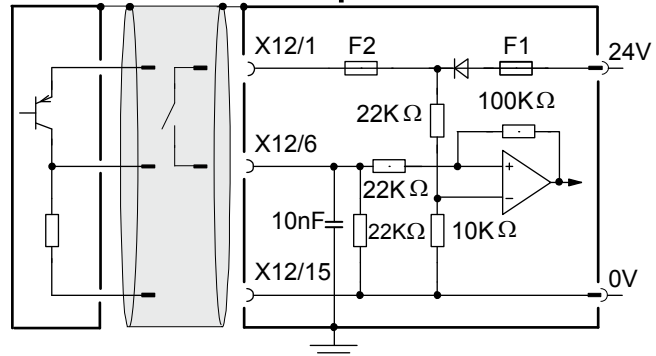

The circuit example is valid for all digital inputs!

Signal level:

- ◆ > 9.15V = "1" (38.2% of the control voltage applied)
- ◆ < 8.05V = "0" (33.5% of the control voltage applied)

F1: Delayed action fuse

F2: Quick action electronic fuse; can be reset by switching the 24 VDC supply off and on again.

3.8.3.2 Logic proximity switch types

Type	1	2	3	4
Transistor switch	PNP	PNP	NPN	NPN
Logic	(N.O.) "active high"	(N.C) "active low"	(N.O.) "active low"	(N.C) "active high"
Description of logic	Compax3 sees a logical "1" upon activation	Compax3 sees a logical "0" upon activation	Compax3 sees a logical "0" upon activation	Compax3 sees a logical "1" upon activation
Fail safe logic	no	yes	Only conditional ¹⁾	no
Instruction for pull up resistor in the initiator	-	-	R _{min} =3k3 R _{max} =10k ²⁾	R _{min} =3k3 R _{max} =10k ²⁾
Connections				

¹⁾ When the connection between transistor emitter of the initiator and X12/15 (GND24V of the Compax3) is lost, it can not be guaranteed, that the Compax3 detects a logical „0“.

²⁾ The INSOR NPN types INHE5212 and INHE5213 manufactured by Schönbuch Electronic do correspond to this specification.

3.9 Mounting and dimensions

In this chapter you can read about:

Mounting and dimensions Compax3S.....	66
Mounting and dimensions PSUP/C3M.....	70
Mounting and dimensions C3H.....	72

3.9.1. Mounting and dimensions Compax3S

3.9.1.1 Mounting and dimensions Compax3S0xxV2

Mounting:

3 socket head screws M5

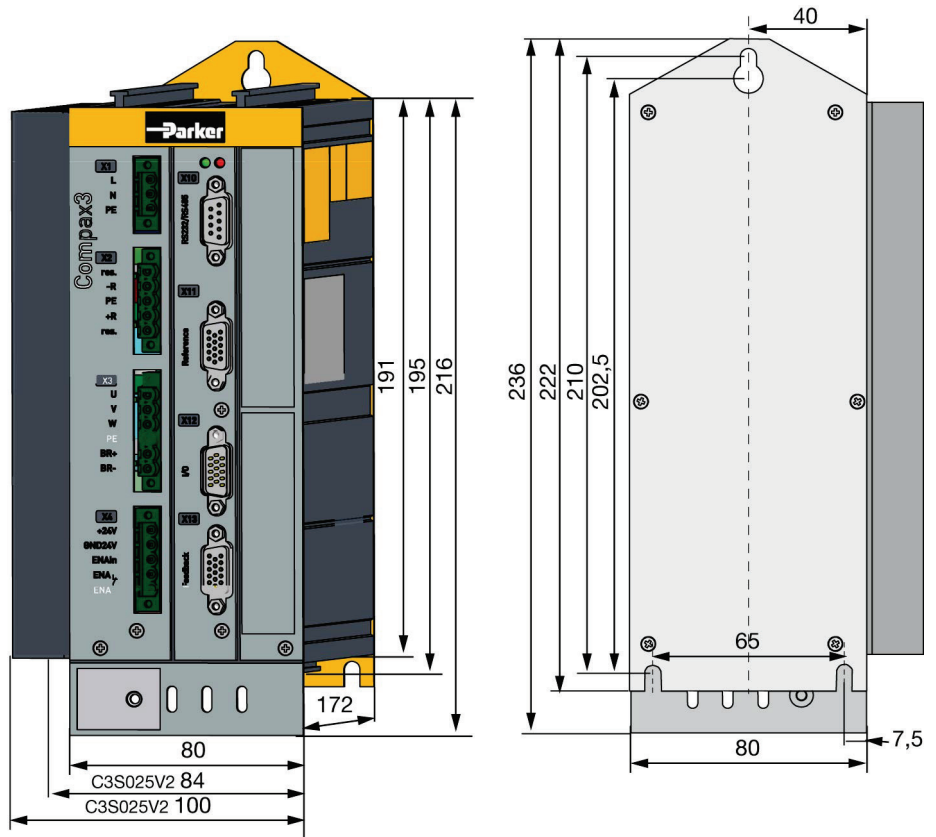

Stated in mm

Please respect an appropriate mounting gap in order to ensure sufficient convection:

- ◆ At the side: 15mm
- ◆ At the top and below: at least 100mm

3.9.1.2 Mounting and dimensions Compax3S100V2 and S0xxV4

Mounting:

3 socket head screws M5

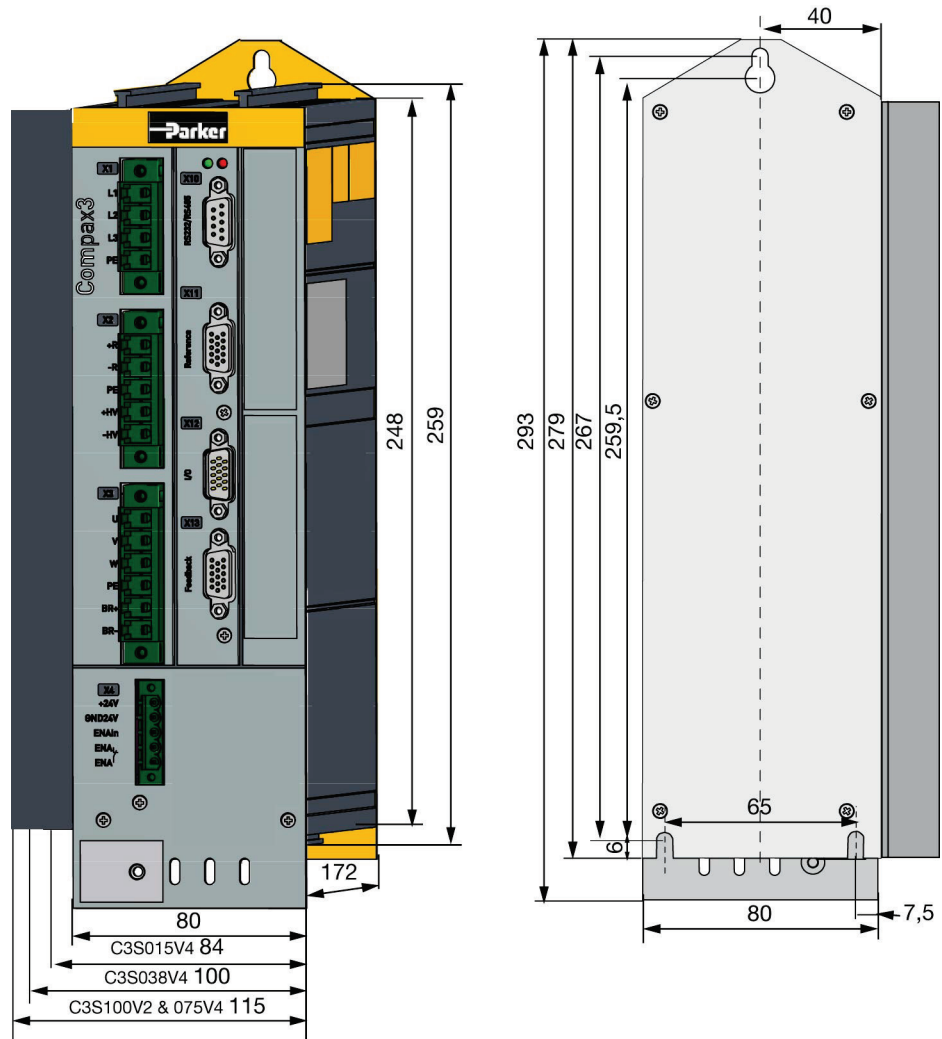

Stated in mm

Please respect an appropriate mounting gap in order to ensure sufficient convection:

- ◆ At the side: 15mm
- ◆ At the top and below: at least 100mm

3.9.1.3 Mounting and dimensions Compax3S150V2 and S150V4

Mounting:

4 socket head screws M5

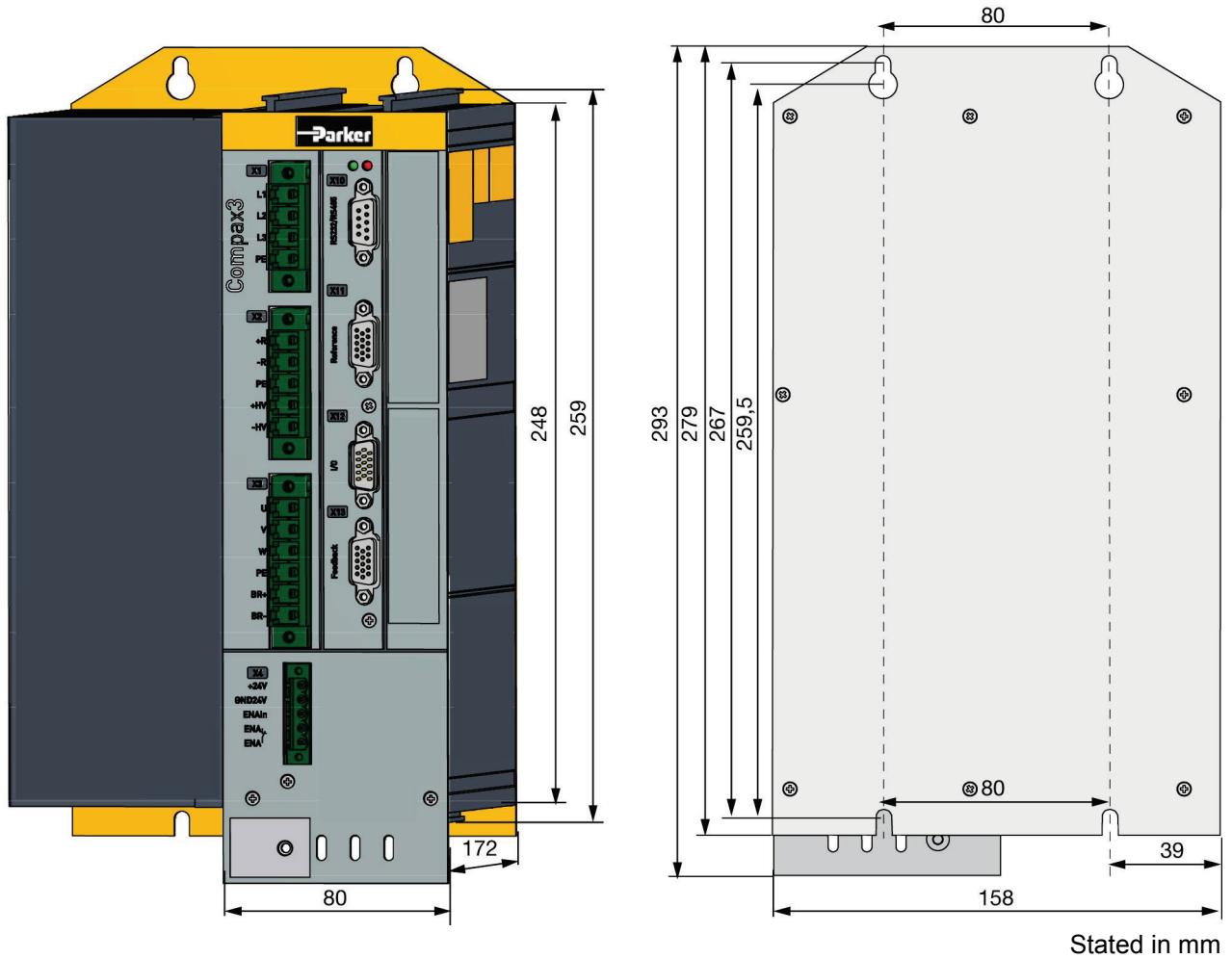

Stated in mm

Please respect an appropriate mounting gap in order to ensure sufficient convection:

- ◆ At the side: 15mm
- ◆ At the top and below: at least 100mm

3.9.1.4 Mounting and dimensions Compax3S300V4

Mounting:

4 socket head screws M5

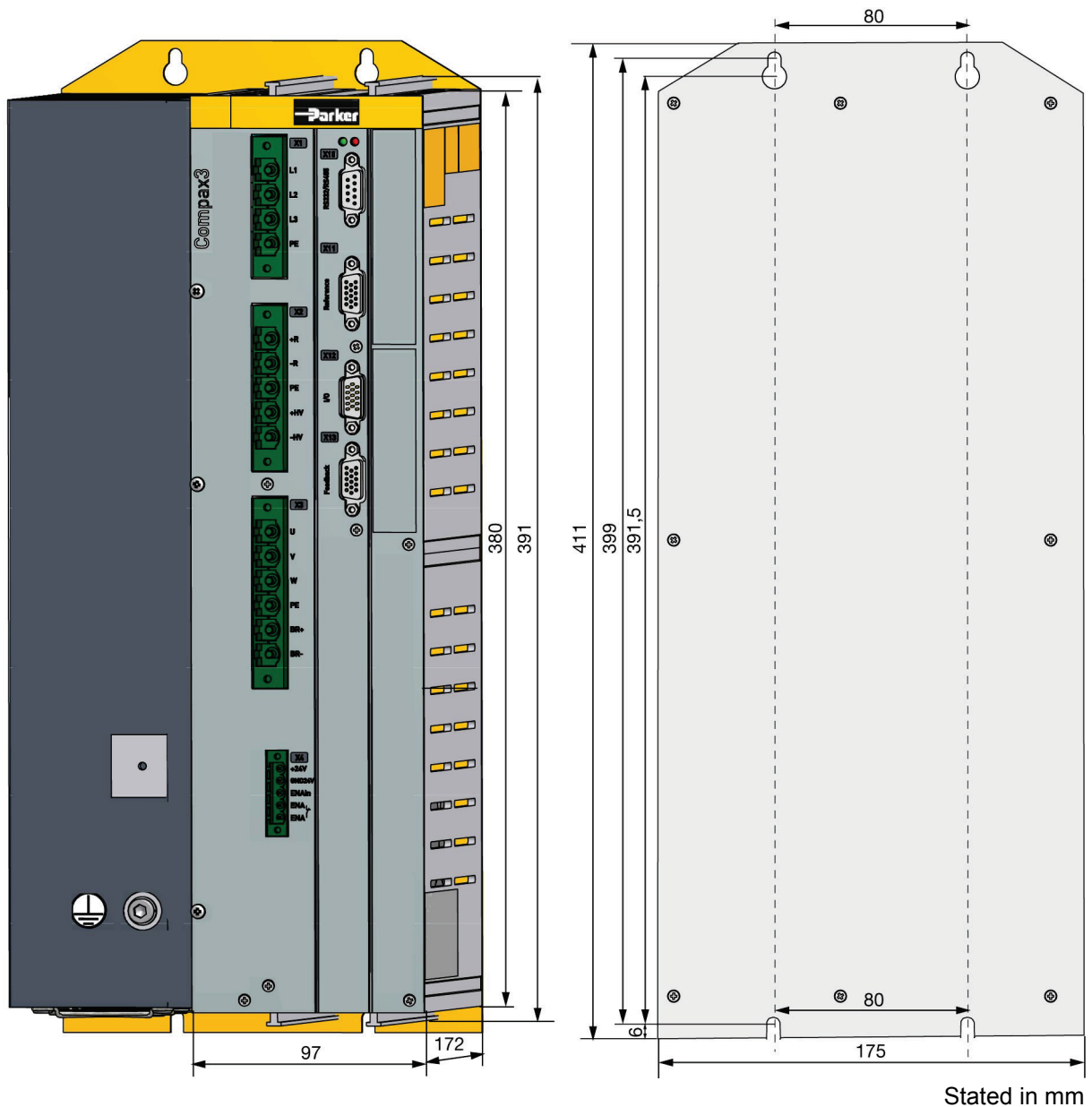

Stated in mm

Please respect an appropriate mounting gap in order to ensure sufficient convection:

- ◆ At the side: 15mm
- ◆ At the top and below: at least 100mm

Compax3S300V4 is force-ventilated via a fan integrated into the heat dissipator!

3.9.2. Mounting and dimensions PSUP/C3M

Ventilation: During operation, the device radiates heat (power loss). Please provide for a sufficient mounting distance below and above the device in order to ensure free circulation of the cooling air. Please do also respect the recommended distances of other devices. Make sure that the mounting plate is not exhibited to other temperature influences than that of the devices mounted on this very plate. The devices must be mounted vertically on a level surface. Make sure that all devices are sufficiently fixed.

3.9.2.1 Mounting and dimensions PSUP10/C3M050D6, C3M100D6, C3M150D6

The devices are force-ventilated via a ventilator fan fixed to the lower part of the heat dissipator!

Mounting spacing: At the top and below: at least 100mm

Information on PSUP10D6/C3M050D6, C3M100D6, C3M150D6

Mounting:
2 socket head screws M5

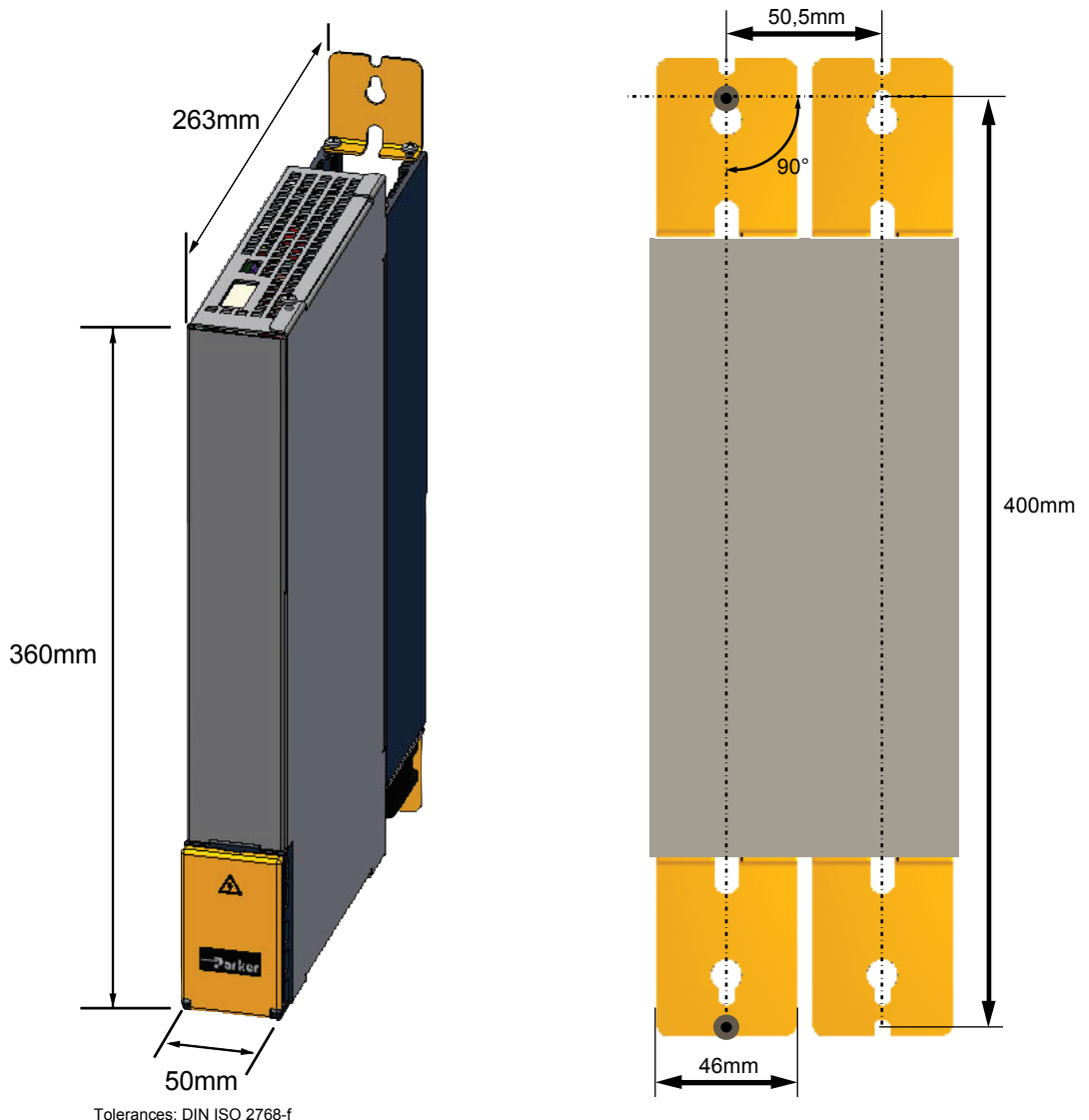

3.9.2.2 Mounting and dimensions PSUP20/PSUP30/C3M300D6

Information on PSUP20/PSUP30/C3M300D6

Mounting:
4 socket head screws M5

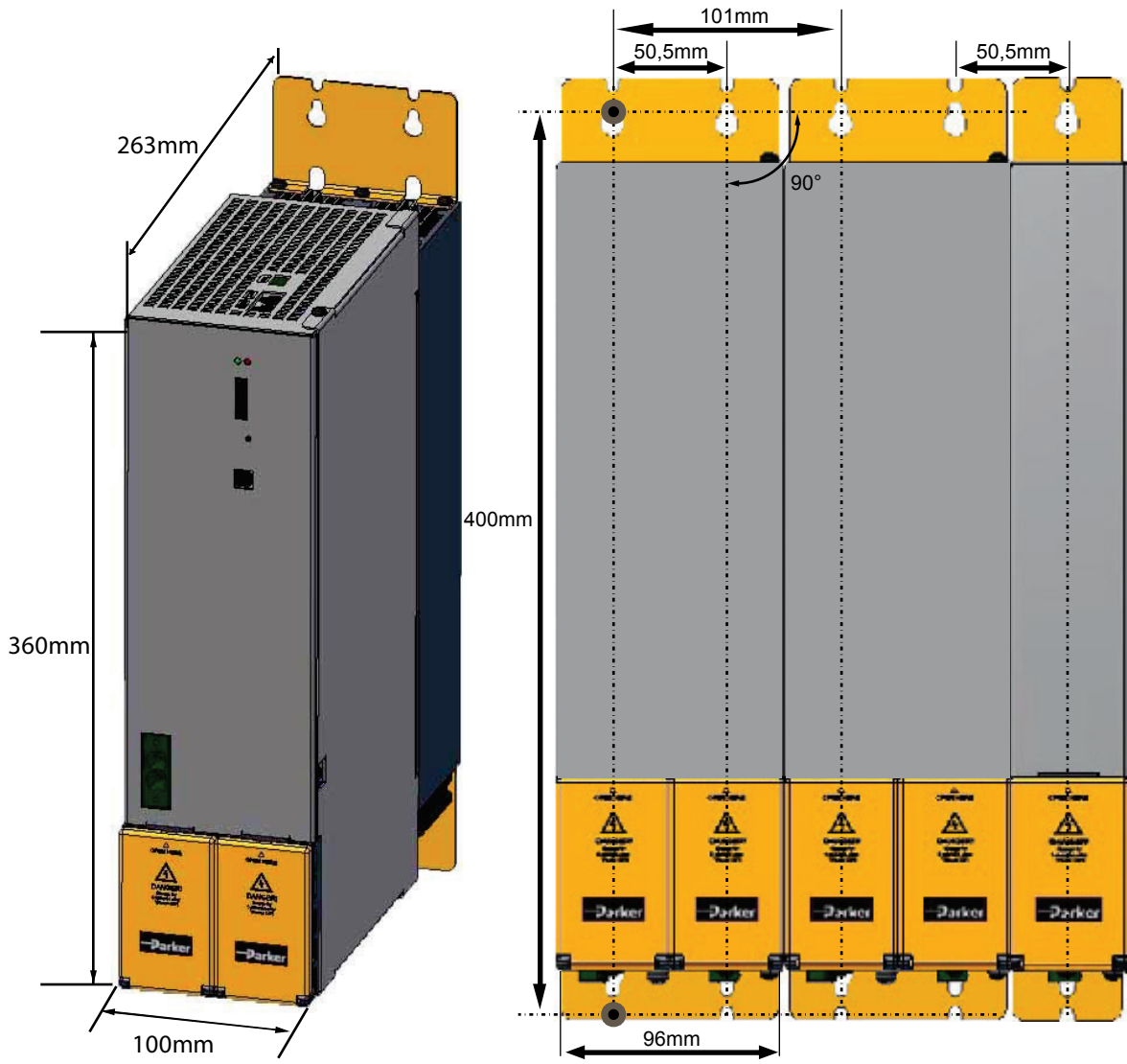

Tolerances: DIN ISO 2768-f

3.9.2.3 With upper mounting, the housing design may be different

Mounting:
3 socket head screws M5

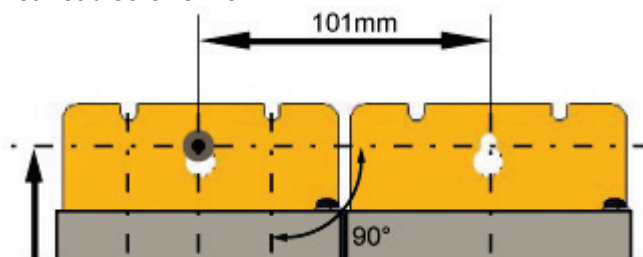

3.9.3. Mounting and dimensions C3H

The devices must be mounted vertically on a level surface in the control cabinet.

Dimensions:

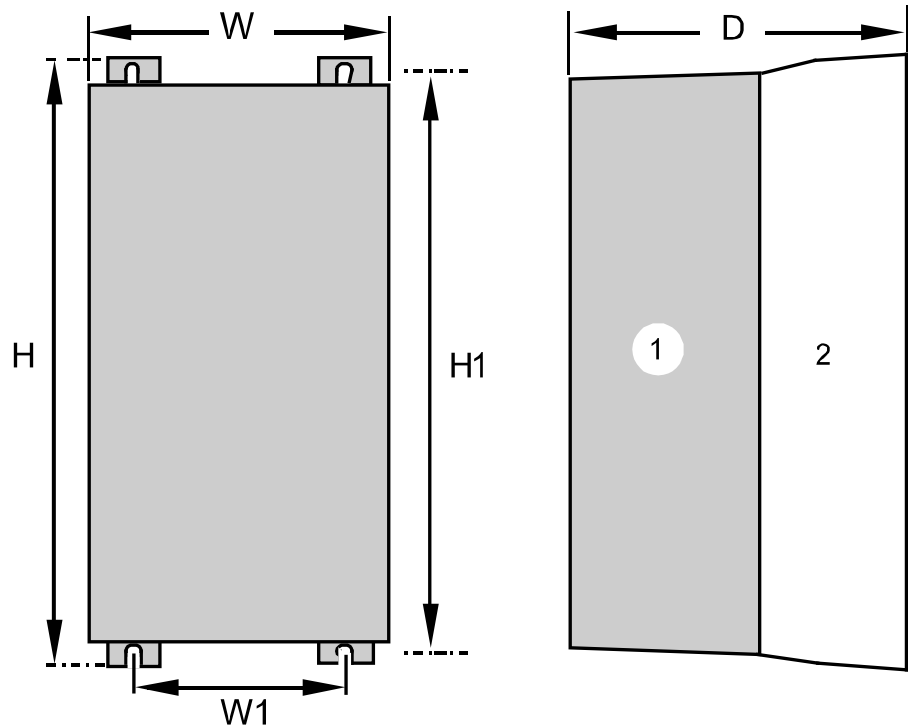

(1): Electronics
(2): Head dissipator

	H	H1	D	W	W1
C3H050V4	453mm	440mm	245mm	252mm	150mm
C3H090V4	668.6mm	630mm	312mm	257mm	150mm
C3H1xxV4	720mm	700mm	355mm	257mm	150mm

Mounting:4 screws M6

Ventilation: During operation, the device radiates heat (power loss). Please provide for a sufficient mounting distance below and above the device in order to ensure free circulation of the cooling air. Please do also respect the recommended distances of other devices. Make sure that the mounting plate is not exhibited to other temperature influences than that of the devices mounted on this very plate. If two or more devices are combined, the mounting distances are added.

3.9.3.1 Mounting distances, air currents Compax3H050V4

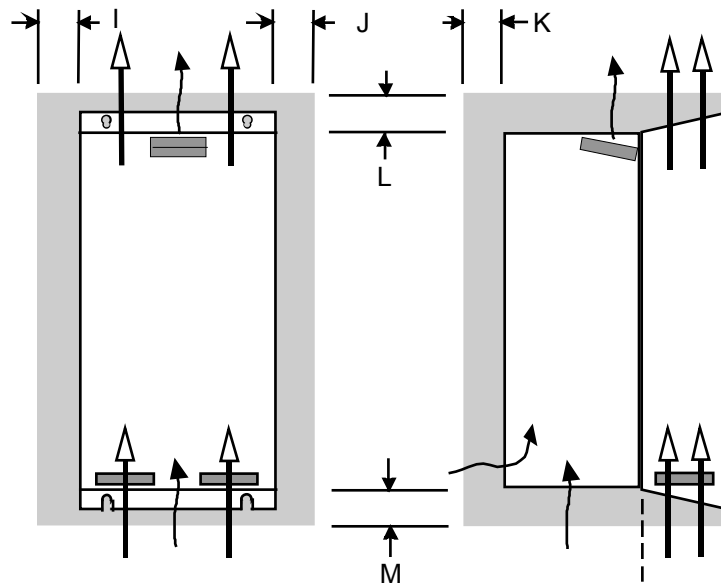

in mm

	I	J	K	L	M
C3H050V4	15	5	25	70	70

3.9.3.2 Mounting distances, air currents Compax3H090V4

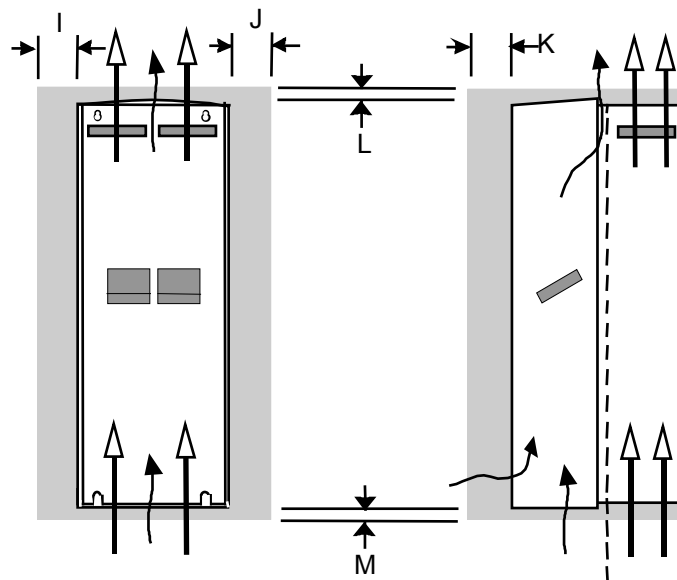

in mm

	I	J	K	L	M
C3H090V4	0	0	25	70	70

3.9.3.3 Mounting distances, air currents Compax3H1xxV4

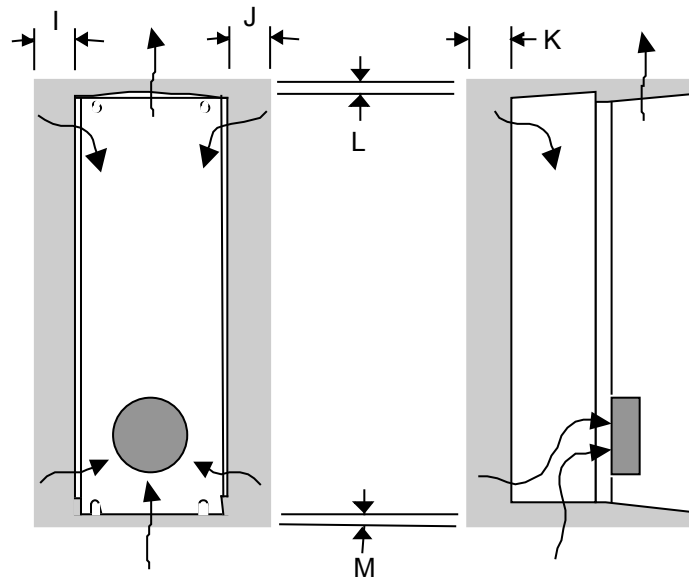

in mm

	I	J	K	L	M
C3H1xxV4	0	0	25	70	70

3.10 Safety function - STO (=safe torque off)

In this chapter you can read about:

General Description.....75
 STO (= safe torque off) with Compax3S78
 STO (= safe torque off) with Compax3m (Option S1).....85

3.10.1. General Description

In this chapter you can read about:

Important terms and explanations.....75
 Intended use.....76
 Advantages of using the "safe torque off" safety function.....76
 Devices with the STO (=safe torque off) safety function.....77

The present documentation assumes a basic knowledge of our drive controllers as well as an understanding of safety-oriented machine design. References to standards and other regulations are only rudimentarily expressed. For complementary information, we recommend the respective technical literature.

3.10.1.1 Important terms and explanations

Term	Explanation
Safety category 3 in accordance with EN ISO 13849-1	Definition according to standard: Circuit with safety function against individual errors. Some, but not all errors are detected. An accumulation of errors may lead to a loss of the safety function. The remaining risk is accepted. The determination of the safety category required for an application (risk analysis) lies within the responsibility of the machine manufacturer. It can take place according to the method described in EN ISO 13849-1, appendix A.
"Safe torque off" or abbreviated: STO=Safe torque off	With the "safe torque off", the energy supply of the drive is safely interrupted according to EN 1037, paragraph 4.1. The drive is not to be able to produce a torque and thus dangerous movements (see EN 1037, paragraph 5.3.1.3). The standstill position must not be monitored. If an external force effect, e.g. a drop of hanging loads, is possible with the "safe torque off", additional measures to safely prevent those must be provided (e.g. additional mechanical brakes). The following measures are appropriate for a "safe torque off": Contactor between mains and drive system (mains contactor) Contactor between power section and motor (motor contactor) Safe blocking of the power semiconductor control (start inhibitor)
Start inhibitor	Safe blocking of the power semiconductor control. With the aid of this function, you can obtain a "safe torque off".

Stop categories according to EN60204-1 (9.2.2)

Stop category	Safety function	Requirement	System behavior	Remark
0	Safe torque off (STO)	Stopping by immediately switching off the energy supply of the machine drive elements	Uncontrolled stop	Uncontrolled stop is the stopping of a machine movement by switching off the energy of the machine drive elements. Available brakes and/or other mechanical stopping components are applied.
1	Safe stop 1 (SS1)	Stop where the energy of the machine drive elements is maintained in order to reach a stop. The energy supply is only interrupted, if the standstill is attained.	Controlled stop	Controlled stop is the stopping of a machine movement by for instance resetting the electrical command signal to zero, as soon as the stop signal has been detected by the controller, the electrical energy for the machine drive elements remains however during the stopping procedure.
2	Safe stop 2 (SS2)	Stop where the energy to the machine drive elements is maintained.	Controlled stop	This category is not covered.

3.10.1.2 Intended use

The Compax3 drive controller supports the "safe torque off" (STO) safety function, with protection against unexpected startup according to the requirements of EN ISO 13849-1, category 3 to PLe and EN 1037.

Together with the external safety control device, the "safe stop 1" (SS1) safety function according to the requirements of EN ISO 13849-1 category 3 can be used. As the function is however realized with the aid of an individually settable time delay on the safety switching device, you must take into account that, due to an error in the drive system during the active braking phase, the axis trundles to a stop unguided or may even accelerate actively in the worst case until the expiry of the preset switch-off time.

According to a risk evaluation which must be carried out according to the machine standard 98/37/EG and 2006/42/EG or EN ISO 12100, EN ISO 13849-1 and EN ISO 14121-1, the machine manufacturer must project the safety system for the entire machine including all integrated components. This does also include the electrical drives.

Qualified personnel

Projecting, installation and setup require a detailed understanding of this description.

Standards and accident prevention regulation associated with the application must be known and respected as well as risks, protective and emergency measures.

3.10.1.3 Advantages of using the "safe torque off" safety function.

Safety category 3 in accordance with EN ISO 13849-1

Requirements performance feature	Use of the safe torque off function	Conventional solution: Use of external switching elements
Reduced switching overhead	Simple wiring, certified application examples Grouping of drive controllers on a mains contactor is possible.	Two safety-oriented power contactors in series connection are required.
Use in the production process High operating cycles, high reliability, low wear	Extremely high operating cycles thanks to almost wear-free technology (low-voltage relay and electronic switch). The "safe torque off" status is attained due to the use of wear-free electronic switches (IGBTs).	This performance feature cannot be reached with conventional technology.
Use in the production process High reaction speed, fast restart	Drive controller remains performance- and control-oriented in connected state. No significant waiting times due to restart.	When using power contactors in the supply, a long waiting time for the energy discharge of the DC link circuit is required. When using two power contactors on the motor side, the reaction times may increase, you must however take into consideration other disadvantages: a) Securing that switching takes only place in powerless state (Direct current! Constant electric arcs must be prevented). b) Increased overhead for EMC conform wiring.
Emergency-stop function	According to the German version of the standard: Permitted without control of mechanical power switching elements 1)	Switch-off via mechanical switching elements is required

1) According to the preface of the German version of the EN 60204-1/11.98, electronic equipment for emergency-stop devices are also permitted, if they comply with the safety categories as described in EN ISO 13849-1.

3.10.1.4 Devices with the STO (=safe torque off) safety function

The STO (Safe torque off) safety function is implemented in the following devices:

Compax3 technology function

- ◆ I10T10, I11T11, I12T11,
- ◆ I10T20, I20T20, I32T20
- ◆ I11T30, I20T30, I21T30, I22T30, I30T30, I31T30, I32T30,
I11T40, I20T40, I21T40, I22T40, I30T40, I31T40, I32T40
I11T70, I20T70, I32T70
- ◆ I20T11, I21T11, I22T11, I30T11, I31T11, I32T11
- ◆ C10T11, C10T30, C10T40,
C13T11, C13T30, C13T40,
C20T11, C20T30, C20T40

with the device power / series

S025V2, S063V2, S100V2, S150V2, S015V4, S038V4, S075V4, S150V4,
S300V4

M050D6, M100D6, M150D6, M300D6,

and is only valid with the stated conditions of utilization.

3.10.2. STO (= safe torque off) with Compax3S

In this chapter you can read about:

STO Principle (= Safe Torque Off) with Compax3S	78
Conditions of utilization STO (=safe torque off) Safety function.....	80
Notes on the STO function.....	80
STO application example (= safe torque off).....	81
Technical Characteristics STO Compax3S	84

3.10.2.1 STO Principle (= Safe Torque Off) with Compax3S

To ensure safe protection against a motor starting up unexpectedly, the flow of current to the motor and thus to the power output stage must be prevented. This is accomplished for Compax3S with two measures independent of each other (Channel 1 and 2), without disconnecting the drive from the power supply:

Channel 1:

Activation of the power output stage can be disabled in the Compax3 controller by means of a digital input or with a fieldbus interface (depending on the Compax3 device type) (deactivation of the energize input).

Channel 2:

The power supply for optocouplers and drivers of power output stage signals is disconnected by a safety relay activated by the enable input "ENAIin"(X4/3) and equipped with force-directed contacts. This prevents control signals from being transferred to the power output stage.



**The STO (= Safe Torque Off) safety function in accordance with EN ISO 13849-1: 2008 PLd or PLe, Kat.3 is only possible when using both channels via an external safety switching device
Please note the application examples!**

Circuit diagram illustrating working principle:

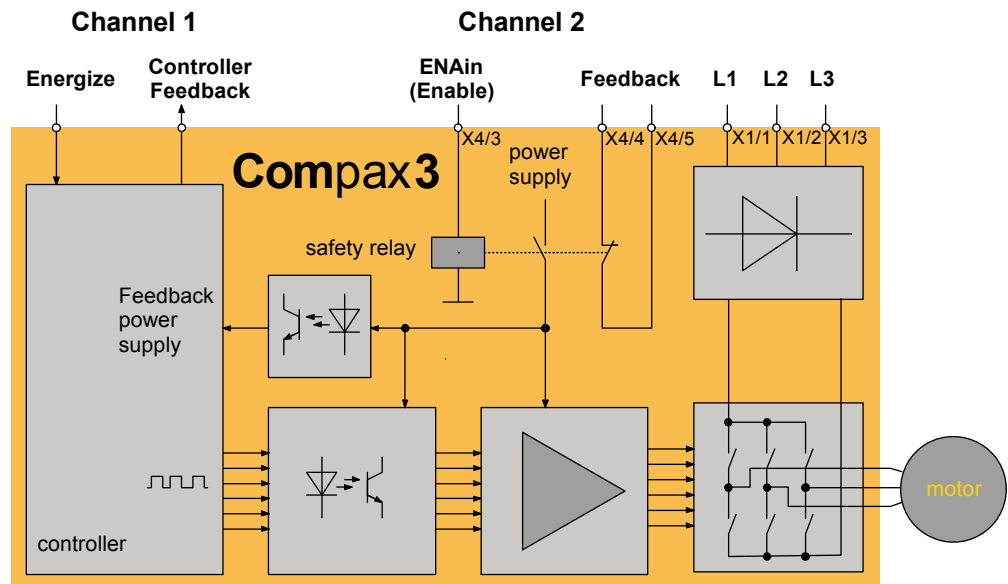

Notes

- ◆ In normal operation of Compax3, 24VDC of power is supplied to the "Enable" input (X4/3). The control of the drive takes then place via the digital inputs/outputs or via the fieldbus.

STO delay times

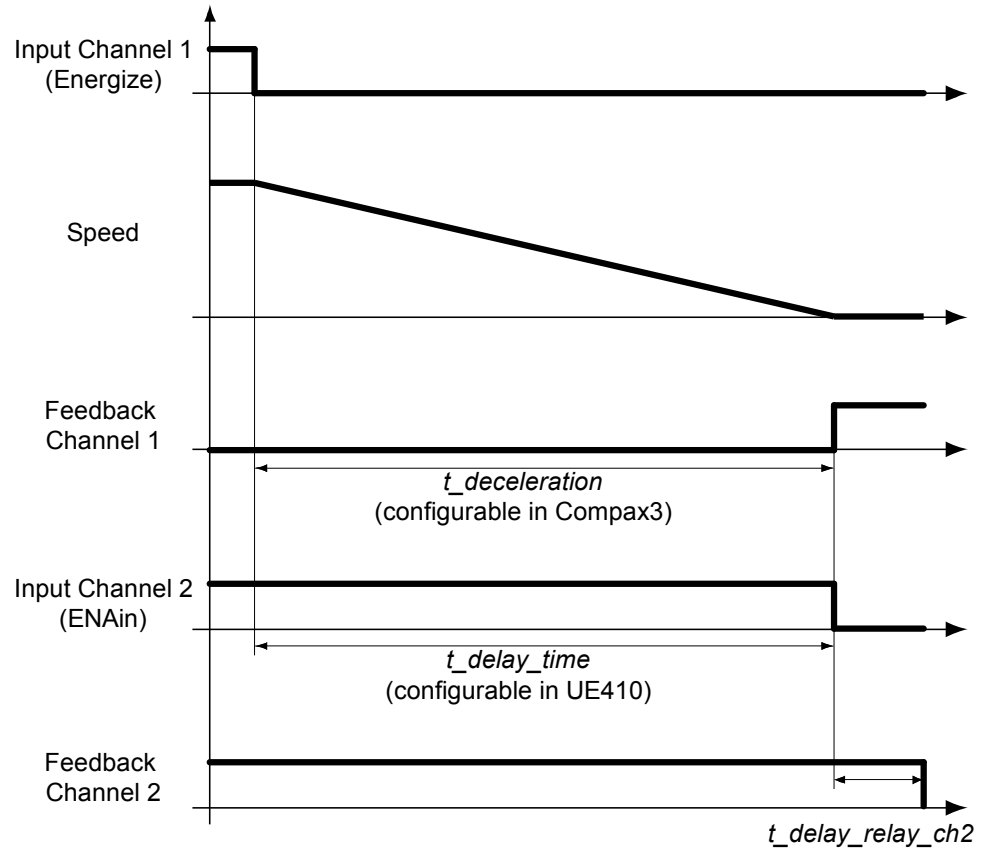

The deceleration time $t_{deceleration}$ depends on the configuration of the Compax3. It must be configured so that oscillation free bringing to standstill is possible, depending on the mechanical load. The delay time t_{delay_time} must be set in the safety control device UE410 so that $t_{delay_time} > t_{deceleration}$. Only after the elapsing of the relay delay $t_{delay_relay_ch2}$, the STO function is completely activated. The relay delay time $t_{delay_relay_ch2}$ is 15 ms.

3.10.2.2 Conditions of utilization STO (=safe torque off) Safety function

- ◆ STO can only be implemented in Compax3 with a corresponding safety switching device considering the application examples.
- ◆ Safety functions must be tested 100%.
- ◆ The Compax3S and the safety switching device used must be mounted in a protected way (IP54 mounting cabinet).
- ◆ Only qualified staff members are permitted to install the STO (=safe torque off) function and place it in service.
- ◆ For all applications in which the first channel of the “Safe torque off” is implemented by means of a PLC, care must be taken that the part of the program that is responsible for current flowing to or not flowing to the drive is programmed with the greatest possible care. The Safe Torque off application example of Compax3 with fieldbus should be considered.
The designer and operator responsible for the system and machine must refer programmers who are involved to these safety-related points.
- ◆ Terminal X4/2 (GND 24 V and at the same time the reference point for the safety relay bobbin) must be connected with the PE protective lead. This is the only way to ensure protection against incorrect operation through earth faults (EN60204-1 Section 9.4.3)!
- ◆ All conditions necessary for CE-conform operation must be observed.
- ◆ When using an external safety switching device with adjustable delay time, (as illustrated in the STO application example), it must be ensured that the delay time cannot be adjusted by persons not authorized to do so (for example by applying a lead seal). With the UE410-MU3T5 safety switching device, this is not necessary, if the anti manipulation measures are respected.
- ◆ The adjustable delay time on the safety switching device must be set to a value greater than the duration of the braking ramp controlled by the Compax3 with maximum load and maximum speed.
If the setting range for the specified Emergency power-off module is not sufficient, the Emergency power-off module must be replaced by another equivalent module.
- ◆ All safety-related external leads (for example the control lead for the safety relay and feedback contact) must absolutely be laid so they are protected, for example in a cable duct. Short circuits and crossed wires must be reliably excluded!
- ◆ If there are external forces operating on the drive axes, additional measures are required (for example additional brakes). Please note in particular the effects of gravity on suspended loads!

3.10.2.3 Notes on the STO function

- ◆ It should be noted in connection with the STO (= safe torque off) application example illustrated here that after the Emergency stop switch has been activated, no galvanic isolation in accordance with EN 60204-1 Section 5.5 is guaranteed. This means that the entire system must be disconnected from the mains power supply with an additional main switch or mains power contactor for repair jobs. Please note in this regard that even after the power is disconnected, dangerous electrical voltages may still be present in the Compax3 drive for about 10 minutes.
- ◆ During the active braking phase of Stop category 1 (controlled bringing to a stop with safely monitored delay time according to EN60204-1) or safe stop 1, faulty function must be expected. If an error in the drive system or mains failure occurs during the active braking phase, the axis may trundle to a stop unguided or might even actively accelerate until the expiry of the defined switch-off time.
- ◆ Please note that the control of the drive via Energize (Energize input or fieldbus interface) is not executed in all operating conditions. The following restrictions apply when the set-up window of the C3 ServoManager is used:
 - ◆ If the setup mode is switched on, the fieldbus interface and the energize input are blocked.
 - ◆ the energize input can be ignored if the input simulator is activated (depending on the settings).

Note on error switch-off

	<p><u>If the "safe torque off" function of Compax3 is required or used for a machine or system, the two errors:</u></p> <ul style="list-style-type: none"> ◆ "Motor_Stalled" (Motor stalled) and ◆ "Tracking" (following error) <p><u>are not to be switched off (see on page 128, see on page 147).</u></p>
---	--

Note on RS485 implementation: The "Energize" function (channel 1) can be implemented via the RS485 bus interface (X10) via a corresponding programming of the Compax3.

If, in this case, the motor current is to be disabled via channel 1, the Bit0 of the DeviceControl (Control word_1) must be set to "LOW" via the RS485 bus interface.

3.10.2.4 STO application example (= safe torque off)

The application example described here corresponds to Stop Category 1 as defined by EN60204-1.

Together with the external safety switching device, the "Safe Stop 1"(SS1) safety function can also be implemented.

A Stop Category 0 in accordance with EN 60204-1 can be implemented, for example by setting the delay time on the Emergency power-off module as well as on the Compax3 (delay time for "switch to currentless") to 0. The Compax3M will then be turned off immediately in 2 channels and will therefore not be able to generate any more torque. Please take into consideration that the motor will not brake and a coasting down of the motor may result in hazards. If this is the case, the STO function in stop category 0 is not permitted.

Circuit layout overview

- ◆ 2 Compax3 devices (the circuit example is also valid for one or multiple devices, if it is adapted accordingly)
- ◆ 1 Emergency Power-off module (UE410-MU3T5 manufactured by Sick)
With adjustable delayed deactivation of the Compax3 enable input ENAi.
The time must be set so that all axes are at a standstill before the Compax3 controllers are deactivated.
- ◆ The operating instructions of the UE410-MU3T5 safety switching device must be observed.
- ◆ 1 emergency power-off switch
- ◆ Hazardous area accessible via a safety door with safety door switch S6.
- ◆ 1 pushbutton per Compax3
- ◆ For the Energize input on Compax3, a debouncing time > 3 ms must be configured
- ◆ 1 relay per Compax3
The relay must be dimensioned so that it has a lifetime of at least 20 years, taking the cycle time into consideration. If this is not the case, the relays must be exchanged for new relays after expiration of the lifetime.

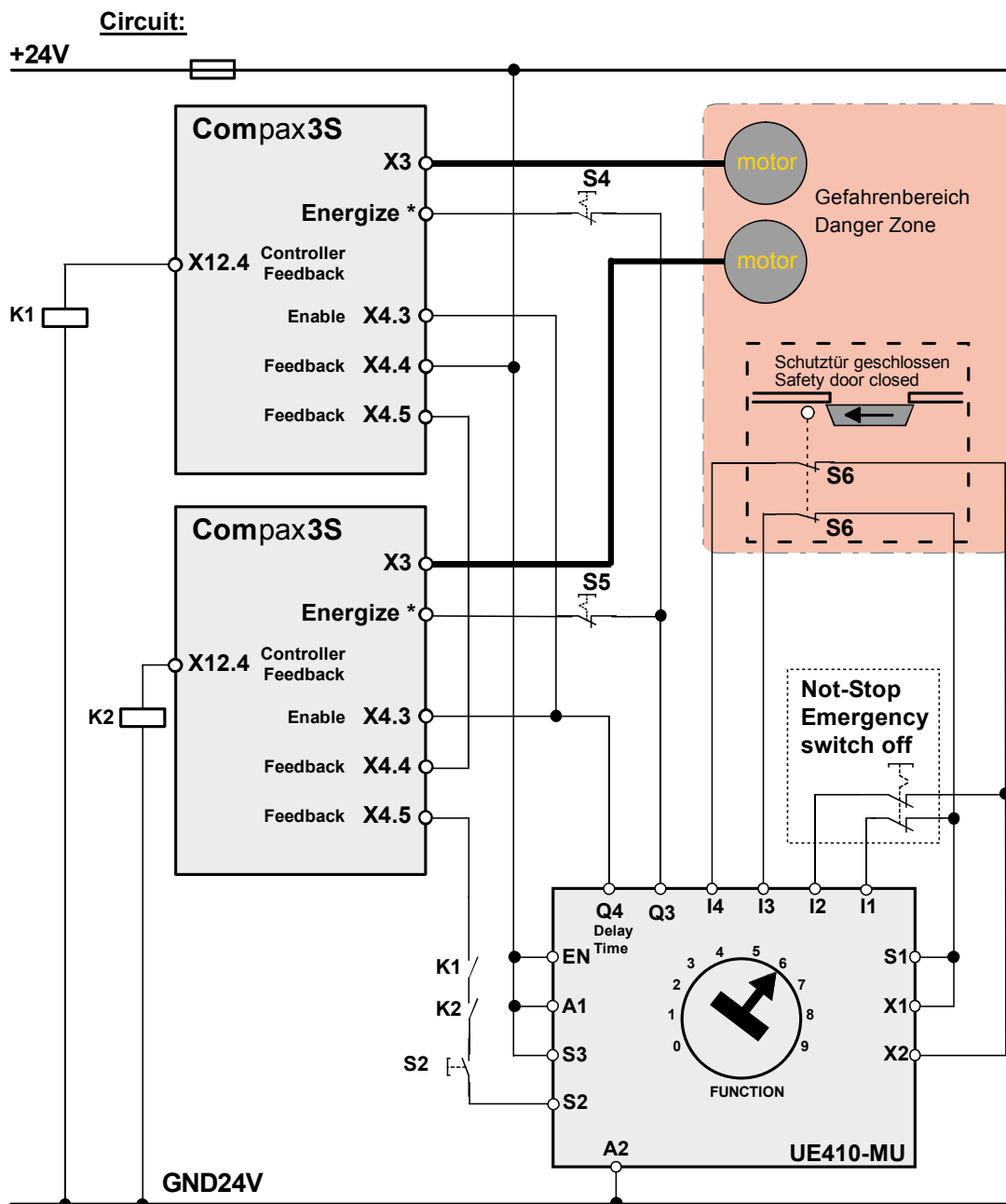

Energize / Ackn = I0 (X12/6)

Instead of the safety switching device manufactured by Sick mentioned above, you may use other safety switching devices.

The safety switching device must however provide the following features:

- ◆ 1 normally open contact is required for switching off channel 1 (as an alternative, a safe semiconductor output is possible)
- ◆ 1 off-delayed normally open safety contact is required for switching off channel 2 (as an alternative, a safe semiconductor output with adjustable delay time for the high_to_low_edge is possible).
- ◆ 1 one-channel monitoring circuit where the feedback contacts of channels 1 and 2 can be integrated for simultaneous monitoring, is required.
At the same time it must be possible to integrate a one-channel start button for activation of the safety switching device into the circuit.
A new start may only be successful, if it is ensured, that channels 1 and 2 are switched off.
- ◆ 1 two-channel connection for emergency power off and/or safety door contacts with cross fault monitoring is required.
- ◆ The safety switching device must feature performance PL e. The I/Os must at least correspond to category 3.

Switches and buttons:

1 N/C (S4, S5) per device:	Guide Device to a currentless state
S6:	closed when the safety door is closed
S2:	Activate safety switching device

Caution! Module UET410-MU3T5 modulates regularly test switching signals (OSSD) on outputs Q3 and Q4.
We recommend to use a filter > 3 ms for signal Q3 in the PLC.
If different safety switching devices are used, please make sure that the pulse width of the test pulses is not wider than 700µs. The safety switching device used can only send test pulses (active low) with high level.

Safe torque off description

In this chapter you can read about:

Safe torque off basic function	83
Access to the hazardous area	84

Safe torque off basic function

Compax3 devices disabled by:

Channel 1: Energize input to "0" by safety switching device output Q3
Channel 2: Enable input ENAI to "0" by safety switching device output Q4

Activate safety switching device

Before the Compax3 can be placed into operation, the safety switching device must be activated by a pulse to Input S2.

Prerequisite:

- ◆ S2 closed
- ◆ Safety door closed
- ◆ K1 and K2 energized
 - ◆ K1: receives current if Compax3 Device 1 is currentless (output = "1" in currentless state) = Channel 1 feedback
 - ◆ K2: receives current if Compax3 device 2 is currentless (output = "1" in the currentless state) = channel 1 feedback
- ◆ The feedback contact of all Compax3 devices must be closed (channel 2).

Energize Compax3 (Motor and power output stage)

- ◆ With the safety switching device, the Compax3 devices are enabled via the energize input and the Enable input ENAI. (If an error is still present in the Compax3, it must be acknowledged - the ackn function depends on the Compax3 device type)
- ◆ The motors are energized with current.

Summary: Compax3 is only energized if the feedback functions are capable of functioning via two channels.

Access to the hazardous area

Actuate emergency power-off switch

Due to the interruption on two channels at the emergency power-off switch, the safety switching device is deactivated - output Q3 is immediately "0".

Channel 1: Via the Energize input, the Compax3 devices receive the command to guide the drive to a currentless state (using the ramp configured in the C3 ServoManager for "drive disable").

Channel 1 feedback 1: The "Controller Feedback" Compax3 outputs supply current to Relays K1 and K2.

Channel 2: After the delay time set in the safety switching device, (this time must be set so that all drives are stopped after it has elapsed) the output Q4 = "0", which in turn deactivates the Enable inputs ENAin of the Compax3 devices.

Channel 2 feedback: Via the series circuit of all feedback contacts, the "Safe Torque-off" status (all Compax3 devices without current) is reported.

Only if the drives are all at a standstill, the safety door may be opened and the hazardous area may be accessed.

If the safety door is opened during operation and the emergency-power-off switch was not triggered before, the Compax3 drives will also trigger the stop ramp.



Caution! The drives may still move.

If danger to life and limb of a person entering cannot be excluded, the machine must be protected by additional measures (e.g. a safety door locking).

3.10.2.5 Technical Characteristics STO Compax3S

Safety technology Compax3S

<p>Safe torque-off in accordance with EN ISO 13849: 2008, Category 3, PL d/e Certified. Test mark IFA 1003004</p>	<ul style="list-style-type: none"> ◆ For implementation of the "protection against unexpected start-up" function described in EN1037. ◆ Please note the circuitry examples (see on page 75).
---	---

Compax3S STO (=safe torque off)

Nominal voltage of the inputs	24 V
Required isolation of the 24V control voltage	Grounded protective extra low voltage, PELV
Protection of the STO control voltage	1 A
Grouping of safety level	<p><500 000 STO cycles per year are assumed.</p> <ul style="list-style-type: none"> ◆ STO switch-off via internal safety relay & digital input: PL e, PFHd=2.98E-8 ◆ STO switch-off via internal safety relay & fieldbus: PL d, PFHd=1.51E-7 (is applicable for a MTTFd=15 years of the external PLC) ◆ Lifetime: 20 Years

◆

3.10.3. STO (= safe torque off) with Compax3m (Option S1)

In this chapter you can read about:

Safety switching circuits.....	85
Safety notes for the STO function in the Compax3M.....	86
Conditions of utilization for the STO function with Compax3M	86
STO delay times.....	87
Compax3M STO application description	88
STO function test.....	91
Technical details of the Compax3M S1 option	93

3.10.3.1 Safety switching circuits

The current flow in the motor windings is controlled by a power semiconductor bridge (6-fold IGBT). A processor circuit and PWM circuit will switch the IGBT with rotary field orientation. Between control logic and power module, optocouplers are used for potential separation.

On the Compax3M drive controller with S1 option, the X14 (STO) connector can be found on the front plate. 2 optocouplers are controlled on two channels via the STO1/ and STO2/ terminals of this connector. When requesting the STO via an external safety switching device, the two auxiliary voltage supply channels of the power stage control circuits are switched off on two channels. Therefore the power transistors (IGBTs) for the motor current can not longer be switched on.

The hardware monitor detects the failure of the optocoupler circuit of a channel by always checking both channels for similarity. If the hardware monitor detects a discrepancy for a defined time (ax. 20s), the error will be stored in the hardware memory. The processor signals this error externally via the 0x5493 error code. An activation of the coupler supply can then only take place via a hardware reset (switching off and on again) of the device.

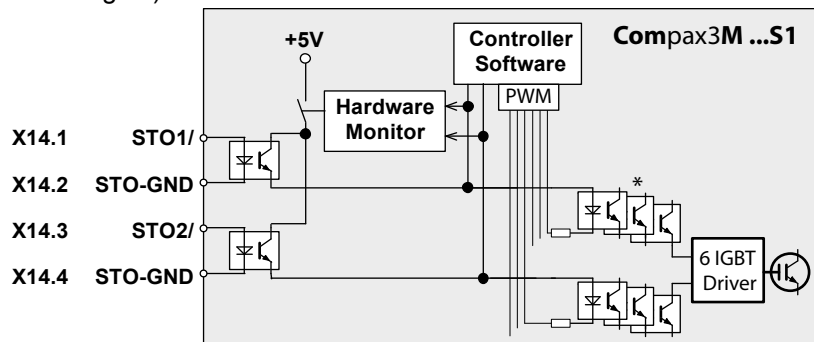

* Potential separation with optocoupler.

3.10.3.2 Safety notes for the STO function in the Compax3M

- ◆ It should be noted in connection with the STO application examples illustrated here that after the Emergency stop switch has been activated, no galvanic isolation in accordance with EN 60204-1 Section 5.5 is guaranteed. This means that the entire system must be disconnected from the mains power supply with an additional main switch or mains power contactor for repair jobs. Please note in this regard that even after the power is disconnected, dangerous electrical voltages may still be present in the Compax3 drive for about 10 minutes.
- ◆ During the active braking phase of Stop category 1 (controlled bringing to a stop with safely monitored delay time according to EN60204-1) or safe stop 1, faulty function must be expected. If an error in the drive system occurs during the active braking phase, the axis may trundle to an unguided stop or might even actively accelerate until the expiry of the defined switch-off time.
- ◆ For synchronous motors operated in the field weakening range, the operation of the STO function may lead to over speed and destructive, life-threatening over voltages as well as explosions in the servo drive. Therefore, NEVER use the STO function with synchronous drives in the field-weakening range.
- ◆ It is important to note that if the drive is being activated (Energize) by the USB / RS485 interface, it may not be possible to execute switch-off by a controlled braking ramp. For example, this is true when the set-up window of the C3 ServoManager is used. If set-up mode is turned on or with the input simulator, the digital I/O interface and fieldbus interface are automatically disabled.

Maintenance

When using the S1 option, a protocol describing the orderly working of the safety function must be made upon the setup and in defined maintenance intervals (see protocol proposal).

3.10.3.3 Conditions of utilization for the STO function with Compax3M

- ◆ The STO safety function must be tested and protocoled **as described** (see on page 91). The safety function must be requested at least once a week. In safety door applications, the weekly testing interval must not be observed, as you can assume that the safety doors will be opened several times during the operation of the machine.
- ◆ The Compax3M with integrated STO safety function as well as the utilized safety switching devices must be mounted protected (IP54 control cabinet).
- ◆ Only qualified staff members are permitted to install the STO function and place it in service.
- ◆ The X9/2 (GND24V) terminal on the PSUPxx mains module must be connected to the PE protective lead. This is the only way to ensure protection against incorrect operation through earth faults (EN60204-1 Section 9.4.3)!
- ◆ When using an external safety switching device with adjustable delay time, (as illustrated in the STO application example), it must be ensured that the delay time cannot be adjusted by persons not authorized to do so (for example by applying a lead seal). With the UE410-MU3T5 safety switching device, this is not necessary, if the anti manipulation measures are respected.
- ◆ The adjustable delay time on the safety switching device must be set to a value greater than the duration of the braking ramp controlled by the Compax3 with maximum load and maximum speed.
- ◆ All conditions necessary for CE-conform operation must be observed.
- ◆ If there are external forces operating on the drive axes, additional measures are required (for example additional brakes). Please note in particular the effects of gravity on suspended loads! This must be respected above all for vertical axes without self-locking mechanical devices or weight balance.
- ◆ When using synchronous motors, a short movement over a small angle is possible, if two errors occur simultaneously in the power section. This depends on the number of pole pairs of the motor (rotary types: 2 poles = 180°, 4 poles = 90°, 6 poles = 60°, 8 poles = 45°, Linear motors: 180° electrically).

3.10.3.4 STO delay times

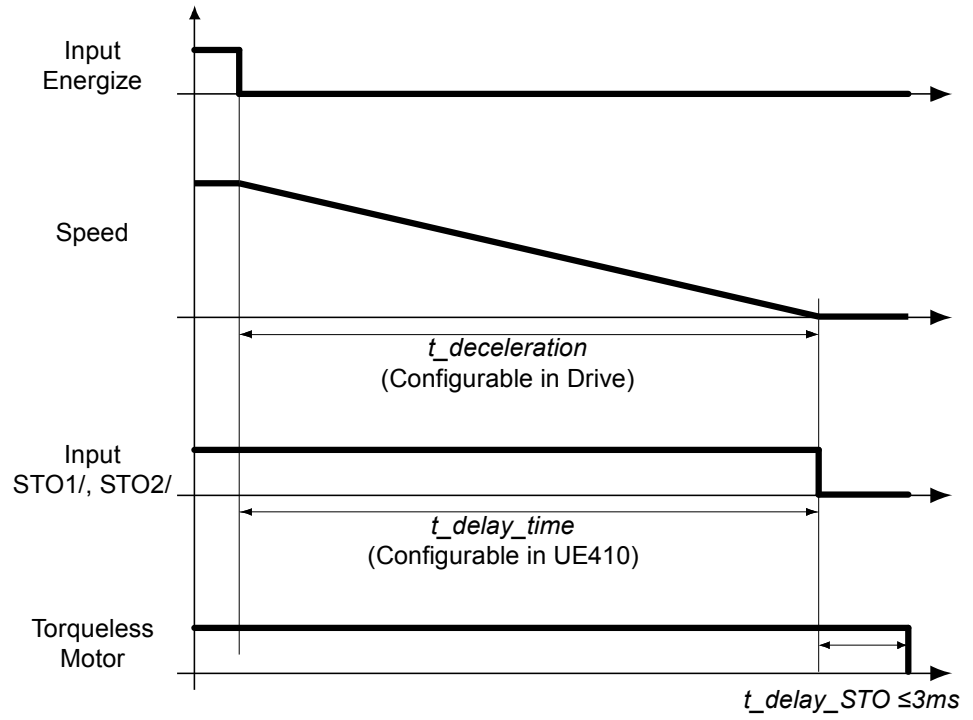

3.10.3.5 Compax3M STO application description

In this chapter you can read about:

STO function with safety switching device via Compax3M inputs.....88
 STO function description89
 Emergency stop and protective door monitoring without external safety switching device.90

STO function with safety switching device via Compax3M inputs

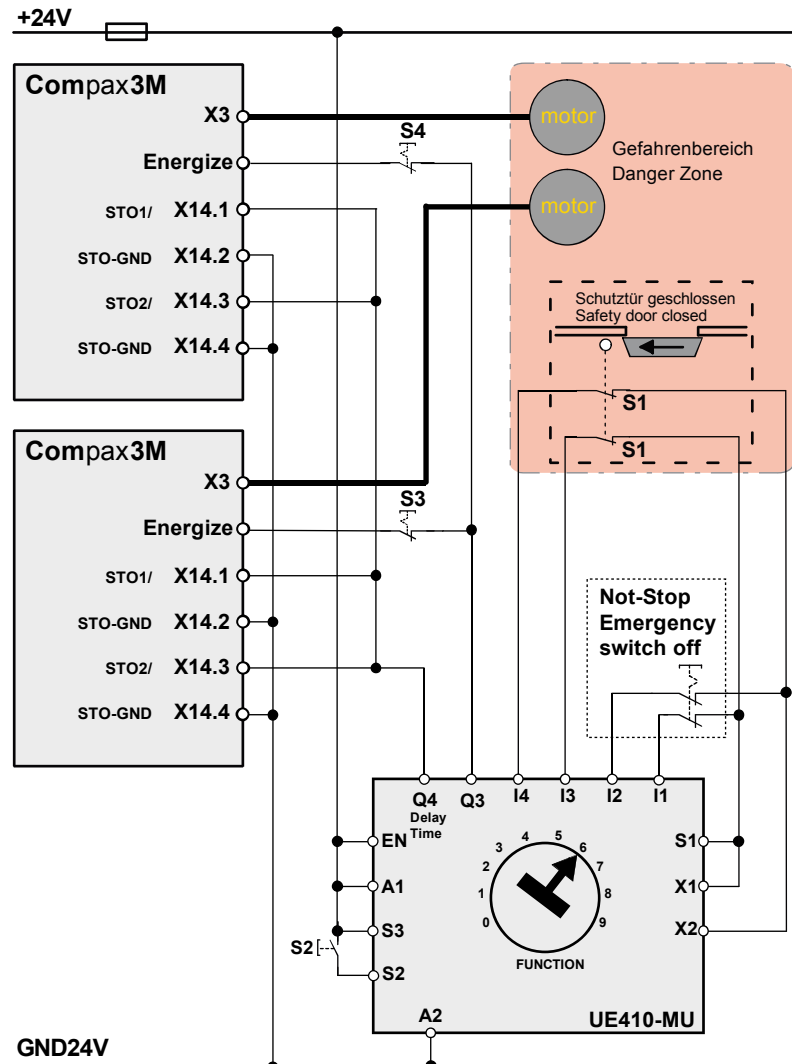

Recommendation Energize = I0 (X12/6) (debounceable digital input)
 The acknowledgement S2 via the safety control UE410-MU3T5 is only necessary, if after the disabling of the STO function, a danger to any person or to the machine could arise by automatic starting. During the **Configuration des Compax3M** (see on page 123) you must see to a debouncing time >3ms being configured for the Energize input.
 The operating instructions of the UE410-MU3T5 safety control must be observed. The Compax3M devices and the UE410-MU3T5 safety control must be mounted in the same control cabinet.

1 N.C. (S3, S4) per device	Guide Device to a currentless state
S1	closed when the safety door is closed
S2	Activate safety switching device

STO function description

When opening the protective door or after actuating the emergency stop switch, the signal of the "energize" input of the Compax3M drive modules is interrupted via the Q3 output on the UE410-MU3T5 safety control. This triggers an immediate braking ramp on the drives. Then after the delay time set on the UE410-MU4T5 safety control, the STO function in the drives is triggered via the Q4 output. The servo drives are then in safe torqueless state. The delay time must be set on the safety control so that the braking ramp in the drives has run off and the drives are at standstill when the delay time has elapsed.

The described application example corresponds to the stop category 1 according to EN 60204-1. Together with the external safety switching device, the "Safe Stop 1" safety function can also be implemented.

A Stop Category 0 in accordance with EN 60204-1 can be implemented, for example by setting the delay time on the safety switching device to 0. The Compax3M will then be turned off immediately in 2 channels and will not be able to generate any more torque. Please take into consideration that the motor will not brake and a coasting down of the motor may result in hazards. If this is the case, the STO function in stop category 0 is not permitted.

Depending on the interface Ixx or technology function Txx of the Compax3M, the "energize" input can be a digital input or for instance a defined bit of a fieldbus control word (see the overview table below).

In the I10T10, I11T11, I12T11, I2xT11 and I3xT11 devices, the ackn input is assigned fixed.

Interface/Technology	"Energize"	Ackn
I10T10	Digital input I0 (X12/6)	I2 (X12/8)
I11T11	Digital input I2 (X12/8) (Energize & Ackn identical)	
I12T11	Digital input I0 (X12/6) (Energize & Ackn identical)	
I2xT11, I3xT11		
I2xT11, I3xT11	Applications with fieldbusses	
I11T30 and I11T40	Debounced digital input defined in the IEC program, which leads to the enable input of the MCpower function module	
I2xT30, I2xT40, I3xT30 and I3xT40	Bit defined in the IEC program (debounced digital input or via fieldbus) which is linked to the enable input of the MCpower function module	
C1xT30 and C1xT40 C20T30 and C20T40	Debounced digital input defined in the IEC program, which leads to the enable inputs of several MCpower function modules for different axes. The information is passed on to the individual axes via the CANbus.	

The acknowledgement via the safety control UE410-MU3T5 is only necessary, if after the disabling of the STO function, a danger to any person or to the machine could arise due to automatic startup..

Emergency stop and protective door monitoring without external safety switching device.

With Compax3M, a 2-channel protective door monitoring switch or a 2 channel emergency power-off switch can be directly connected. The figure below visualizes an application with 2 channel protective door monitoring switch.

The Compax3M drive modules with PSUPxx mains rectifier must be located in a protected area (IP54 control cabinet). Outside this protected area, the line guiding to the external switches must be separated channelwise or must be especially protected (blinded).

It is also permitted to use one acknowledgement switch for both servo drives at a time. In both cases the acknowledgement does only correspond to category B, therefore this acknowledgement should not be used if there is any possibility of stepping in the dangerous area. In this case, an external acknowledgement device must be used.

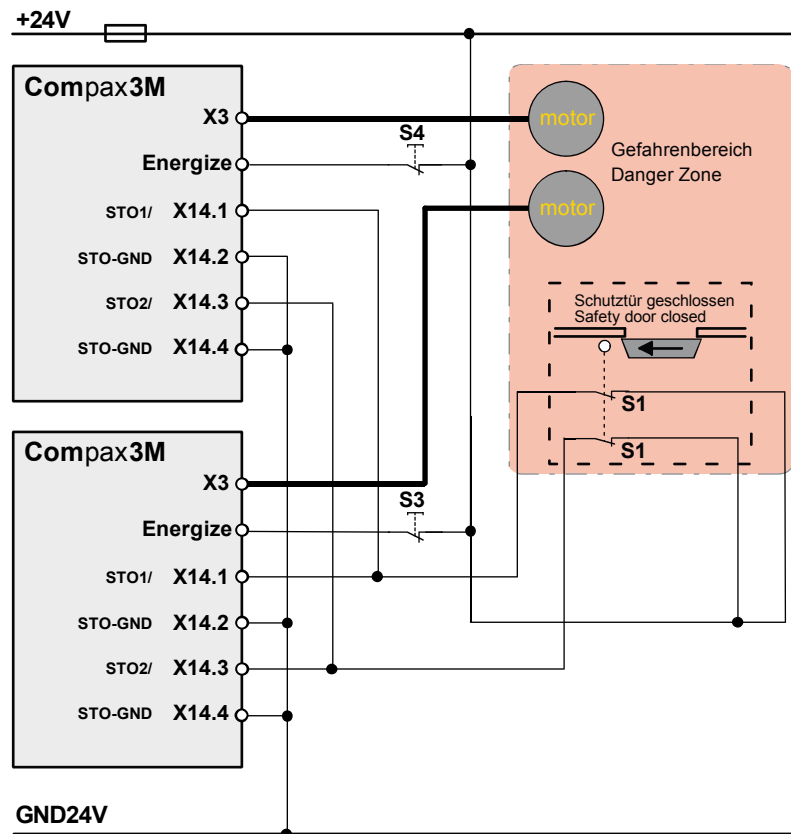

3.10.3.6 STO function test

The STO function must be checked in the event of:

- ◆ Commissioning
- ◆ After each exchange of any equipment within the system
- ◆ After each intervention into the system wiring
- ◆ In defined maintenance intervals (at least once per week) and after a longer standstill of the machine

If the STO function was triggered by opening a protective door and if this door is opened several times a week, the weekly testing interval is not required.

The check must be made by qualified personnel adhering to all necessary safety precautions.

The following testing steps must be performed:

STO Test	Action, activity	Expected reaction and effect
1	24V DC voltage on terminal X14.1 and X14.3	
2	Switch on power and 24V supply voltage	No error must be present
3	Configuring the device	No error must be present
4	Testing active STO on terminal X14.1 and X14.3: Remove 24V DC on terminal X14.1 and X14.3 at the same time	Error message 0x5492 must be present 1)
5	Re-apply 24V DC voltage on terminals X14.1 and X14.3 and then acknowledge error	No error must be present
6	Then switch off and on again 24V voltage supply	No error must be present

1) In order to automate the test, it is sufficient here to monitor the general error output with an external logic.

A manual check of the torqueless drive is here also sufficient.

The triggering of the STO can also be made by actuating the emergency stop switch. During the automated test, the STO can also be triggered via the contacts of an external relay

Following the test steps

The performance of the individual test steps of the STO function must be logged. A protocol specimen can be found in the following section.

Depending on the machine version, additional or other test steps may be required.

STO test protocol specimen (Safety Option S1)

General information:

Project/machine:

Servo axis:

Name of the tester:

STO function test:

Test specification according to the
Compax3 release:

STO function test steps 1-6: successfully tested

Acknowledgement safety switching device: successfully tested
 is not used

Safe stop 1: successfully tested
 is not used

Initial acceptance on:

Repeat check on:

Signature of the tester

Signature of the tester

3.10.3.7 Technical details of the Compax3M S1 option

Safety technology Compax3M

Safe torque-off in accordance with EN ISO 13849-1: 2007, Category 3, PL=e Certified. Test mark MFS 09029	◆ Please respect the stated safety technology on the type designation plate (see on page 12) and the circuitry examples (see on page 85)
---	--

Compax3M S1 Option: Signal inputs for connector X14

Nominal voltage of the inputs	24V
Required isolation of the 24V control voltage	Grounded protective extra low voltage, PELV
Protection of the STO control voltage	1A
Number of inputs Signal inputs via optocoupler	2 Low = 0...7V DC or open High = 15...30V DC I_{in} at 24V DC: 8mA
STO1/	Low = STO activated High = STO deactivated Reaction time max. 3ms
STO2/	Low = STO activated High = STO deactivated Reaction time max. 3ms
Switch-off time with unequal input statuses	20 s (max. error reaction time)
Grouping of safety level	◆ Category 3 ◆ PL=e (according to table 4 in EN ISO 13849-1 this corresponds to SIL 3) ◆ PFHd=4.29E-8 ◆ Lifetime: 20 years

◆

4. Setting up Compax3

In this chapter you can read about:

Configuration	94
Configuring the signal Source	148
Load control	153
Optimization	156

4.1 Configuration

In this chapter you can read about:

Selection of the supply voltage used	95
Motor selection	96
Optimize motor reference point and switching frequency of the motor current	96
Ballast resistor	99
General drive	99
Defining the reference system	100
Defining jerk / ramps	124
Limit and monitoring settings	126
Operating mode / I/O assignment	129
Encoder simulation	134
Absolute- /continuous mode	135
Position mode in reset operation	135
Defining the STOP function	135
Reg-related positioning / defining ignore zone	137
Write into set table	137
Error response	147
Configuration name / comments	147

The general proceeding in order to operate an empty-running motor is described [here](#) (see on page 95).

Configurations sequence:

Installation of the C3 ServoManager

The Compax3 ServoManager can be installed directly from the Compax3 DVD. Click on the corresponding hyperlink resp. start the installation program "C3Mgr_Setup_V.....exe" and follow the instructions.

PC requirements

Recommendation:

Operating system:	MS Windows XP SP3 / MS Vista (32 Bit) / Windows 7 (32 Bit / 64 Bit)
Browser:	MS Internet Explorer 8.x or higher
Processor:	Intel / AMD Multi core processor >=2GHz
RAM memory:	>= 1024MB
Hard disk:	>= 20GB available memory
Drive:	DVD drive (for installation)
Monitor:	Resolution 1024x768 or higher
Graphics card:	on onboard graphics (for performance reasons)
Interface:	USB 2.0

Minimum requirements:

Operating system:	MS Windows XP SP2 / MS Windows 2000 as from SP4
Browser:	MS Internet Explorer 6.x
Processor:	>=1.5GHz
RAM memory:	512MB
Hard disk:	10GB available memory
Drive:	DVD drive
Monitor:	Resolution 1024x768 or higher
Graphics card:	on onboard graphics (for performance reasons)
Interface:	USB

Note:

- ◆ For the installation of the software you need administrator authorization on the target computer.
- ◆ Several applications running in parallel, reduce the performance and operability.
- ◆ Especially customer applications, exchanging standard system components (drivers) in order to improve their own performance, may have a strong influence on the communication performance or even render normal use impossible.
- ◆ Operation under virtual machines such as Vware Workstation 6/ MS Virtual PC is not possible.
- ◆ Onboard graphics card solutions reduce the system performance by up to 20% and cannot be recommended.
- ◆ Operation with notebooks in current-saving mode may lead, in individual cases, to communication problems.

Connection between PC and Compax3

Your PC is connected with Compax3 via a RS232 cable (**SSK1** (see on page 342)).

Start the Compax3 ServoManager and make the setting for the selected interface in the "**Options Communication settings RS232/RS485...**" menu.

Device Selection

In the menu tree under device selection you can read the device type of the connected device (Online Device Identification) or select a device type (Device Selection Wizard).

Configuration

Then you can double click on "Configuration" to start the configuration wizard. The wizard will lead you through all input windows of the configuration.

Input quantities will be described in the following chapters, in the same order in which you are queried about them by the configuration wizard.

In the device online help, we show you at this place an animation of a test setup with the aim to move an unloaded motor.

- ◆ Simple and independent of the Compax3 device variant*
- ◆ Without overhead for configuration
- ◆ Without special knowledge in programming

* for device specific functions, please refer to the corresponding device description.

Due to continuous optimization, individual monitor displays may have changed. This does however hardly influence the general proceeding.

4.1.1. Selection of the supply voltage used

Please select the mains voltage for the operation of Compax3. This influences the choice of motors available.

4.1.2. Motor selection

The selection of motors can be broken down into:

- ◆ Motors that were purchased in Europe and
- ◆ Motors that were purchased in the USA.
- ◆ You will find non-standard motors under "Additional motors" and
- ◆ under "User-defined motors" you can select motors set up with the C3 MotorManager.

For motors with holding brake SMHA or MHA brake delay times can be entered. For this see **Brake delay times** (see on page 268).

Please note the following equivalence that applies regarding terms concerning linear motors:

- ◆ **Rotary motors / linear motors**
- ◆ **Revolutions \equiv Pitch**
- ◆ **Rotation speed (velocity) \equiv Speed**
- ◆ **Torque \equiv Power**
- ◆ **Moment of inertia \equiv Load**

Notes on direct drives (see on page 309) (Linear and Torque - Motors)

4.1.3. Optimize motor reference point and switching frequency of the motor current

Optimization of the motor reference point

The motor reference point is defined by the reference current and the reference (rotational) speed.

Standard settings are:

- ◆ Reference current = nominal current
- ◆ Reference (rotational) speed = nominal (rotational) speed

These settings are suitable for most cases.

The motors can, however, be operated with different reference points for special applications.

- ◆ By reducing the reference (rotational) speed, the reference current can be increased. This results in more torque with a reduced speed.
- ◆ For applications where the reference current is only required cyclically with long enough breaks in between, you may use a reference current higher than I_0 . The limit value is however reference current = max. $1.33 \cdot I_0$. The reference velocity must also be reduced.

The peak current is not changed from Release R09-20, it remains fixed to the value taken from the motor library.

With exception of R09-20, the peak current was also adapted with the changing of the reference current.

The possible settings or limits result from the respective motor characteristics.

Caution!

Wrong reference values (too high) can cause the motor to switch off during operation (because of too high temperature) or even cause damage to the motor.



Optimization of the switching frequency

The switching frequency of the power output stage is preset to optimize the operation of most motors. It may, however, be useful to increase the switching frequency especially with direct drives in order to reduce the noise of the motors. Please note that the power output stage must be operated with reduced nominal currents in the case of increased switching frequencies.

The switching frequency may only be increased.

Caution!

By increasing the motor current switching frequency, the nominal current and the peak current are reduced.

This must already be observed in the planning stage of the plant!



The preset motor current switching frequency depends on the performance variant of the Compax3 device.

The respective Compax3 devices can be set as follows:

Resulting nominal and peak currents depending on the switching frequency

Compax3S0xxV2 at 1*230VAC/240VAC

Switching frequency*		S025V2	S063V2
16kHz	I_{nom}	2.5A _{rms}	6.3A _{rms}
	$I_{peak} (<5s)$	5.5A _{rms}	12.6A _{rms}
32kHz	I_{nom}	2.5A _{rms}	5.5A _{rms}
	$I_{peak} (<5s)$	5.5A _{rms}	12.6A _{rms}

Compax3S1xxV2 at 3*230VAC/240VAC

Switching frequency*		S100V2	S150V2
8kHz	I_{nom}	-	15A _{rms}
	$I_{peak} (<5s)$	-	30A _{rms}
16kHz	I_{nom}	10A _{rms}	12.5A _{rms}
	$I_{peak} (<5s)$	20A _{rms}	25A _{rms}
32kHz	I_{nom}	8A _{rms}	10A _{rms}
	$I_{peak} (<5s)$	16A _{rms}	20A _{rms}

Compax3S0xxV4 at 3*400VAC

Switching frequency*		S015V4	S038V4	S075V4	S150V4	S300V4
8kHz	I_{nom}	-	-	-	15A _{rms}	30A _{rms}
	$I_{peak} (<5s)$	-	-	-	30A _{rms}	60A _{rms}
16kHz	I_{nom}	1.5A _{rms}	3.8A _{rms}	7.5A _{rms}	10.0A _{rms}	26A _{rms}
	$I_{peak} (<5s)$	4.5A _{rms}	9.0A _{rms}	15.0A _{rms}	20.0A _{rms}	52A _{rms}
32kHz	I_{nom}	1.5A _{rms}	2.5A _{rms}	3.7A _{rms}	5.0A _{rms}	14A _{rms}
	$I_{peak} (<5s)$	3.0A _{rms}	5.0A _{rms}	10.0A _{rms}	10.0A _{rms}	28A _{rms}

Compax3S0xxV4 at 3*480VAC

Switching frequency*		S015V4	S038V4	S075V4	S150V4	S300V4
8kHz	I_{nom}	-	-	-	13.9A _{rms}	30A _{rms}
	$I_{peak} (<5s)$	-	-	-	30A _{rms}	60A _{rms}
16kHz	I_{nom}	1.5A _{rms}	3.8A _{rms}	6.5A _{rms}	8.0A _{rms}	21.5A _{rms}
	$I_{peak} (<5s)$	4.5A _{rms}	7.5A _{rms}	15.0A _{rms}	16.0A _{rms}	43A _{rms}
32kHz	I_{nom}	1.0A _{rms}	2.0A _{rms}	2.7A _{rms}	3.5A _{rms}	10A _{rms}
	$I_{peak} (<5s)$	2.0A _{rms}	4.0A _{rms}	8.0A _{rms}	7.0A _{rms}	20A _{rms}

The values marked with grey are the pre-set values (standard values)!

*corresponds to the frequency of the motor current

Resulting nominal and peak currents depending on the switching frequency**Compax3HxxxV4 at 3*400VAC**

Switching frequency*		H050V4	H090V4	H125V4	H155V4
8kHz	I_{nom}	50A _{rms}	90A _{rms}	125A _{rms}	155A _{rms}
	$I_{peak} (<5s)$	75A _{rms}	135A _{rms}	187.5A _{rms}	232.5A _{rms}
16kHz	I_{nom}	33A _{rms}	75A _{rms}	82A _{rms}	100A _{rms}
	$I_{peak} (<5s)$	49.5A _{rms}	112.5A _{rms}	123A _{rms}	150A _{rms}
32kHz	I_{nom}	19A _{rms}	45A _{rms}	49A _{rms}	59A _{rms}
	$I_{peak} (<5s)$	28.5A _{rms}	67.5A _{rms}	73.5A _{rms}	88.5A _{rms}

Compax3HxxxV4 at 3*480VAC

Switching frequency*		H050V4	H090V4	H125V4	H155V4
8kHz	I_{nom}	43A _{rms}	85A _{rms}	110A _{rms}	132A _{rms}
	$I_{peak} (<5s)$	64.5A _{rms}	127.5A _{rms}	165A _{rms}	198A _{rms}
16kHz	I_{nom}	27A _{rms}	70A _{rms}	70A _{rms}	84A _{rms}
	$I_{peak} (<5s)$	40.5A _{rms}	105A _{rms}	105A _{rms}	126A _{rms}
32kHz	I_{nom}	16A _{rms}	40A _{rms}	40A _{rms}	48A _{rms}
	$I_{peak} (<5s)$	24A _{rms}	60A _{rms}	60A _{rms}	72A _{rms}

The values marked with grey are the pre-set values (standard values)!

*corresponds to the frequency of the motor current

Resulting nominal and peak currents depending on the switching frequency**Compax3MxxxD6 at 3*400VAC**

Switching frequency*		M050D6	M100D6	M150D6	M300D6
8kHz	I_{nom}	5A _{rms}	10A _{rms}	15A _{rms}	30A _{rms}
	$I_{peak} (<5s)$	10A _{rms}	20A _{rms}	30A _{rms}	60A _{rms}
16kHz	I_{nom}	3.8A _{rms}	7.5A _{rms}	10A _{rms}	20A _{rms}
	$I_{peak} (<5s)$	7.5A _{rms}	15A _{rms}	20A _{rms}	40A _{rms}
32kHz	I_{nom}	2.5A _{rms}	3.8A _{rms}	5A _{rms}	11A _{rms}
	$I_{peak} (<5s)$	5A _{rms}	7.5A _{rms}	10A _{rms}	22A _{rms}

Compax3MxxxD6 at 3*480VAC

Switching frequency*		M050D6	M100D6	M150D6	M300D6
8kHz	I_{nom}	4A _{rms}	8A _{rms}	12.5A _{rms}	25A _{rms}
	I_{peak} (<5s)	8A _{rms}	16A _{rms}	25A _{rms}	50A _{rms}
16kHz	I_{nom}	3A _{rms}	5.5A _{rms}	8A _{rms}	15A _{rms}
	I_{peak} (<5s)	6A _{rms}	11A _{rms}	16A _{rms}	30A _{rms}
32kHz	I_{nom}	2A _{rms}	2.5A _{rms}	4A _{rms}	8.5A _{rms}
	I_{peak} (<5s)	4A _{rms}	5A _{rms}	8A _{rms}	17A _{rms}

The values marked with grey are the pre-set values (standard values)!

*corresponds to the frequency of the motor current

4.1.4. Ballast resistor

If the regenerative brake output exceeds the **amount of energy that can be stored by the servo controller** (see on page 358), then an error will be generated. To ensure safe operation, it is then necessary to either

- ◆ reduce the accelerations resp. the decelerations,
- ◆ or to use an **external ballast resistor** (see on page 325).

Please select the connected ballast resistor or enter the characteristic values of your ballast resistor directly.

Please note that with resistance values greater than specified, the power output from the servo drive can no longer be dissipated in the braking resistor.

4.1.5. General drive

External moment of inertia / load

The external moment of inertia is required for adjusting the servo controller. The more accurately the moment of inertia of the system is known, the better is the stability and the shorter is the settle-down time of the control loop.

It is important to specify the minimum and maximum moment of inertia for best possible behavior under varying load.

If you do not know the moment of inertia, click on "Unknown: using default values". You have then the possibility to determine the moment of inertia by means of automatic **load identification** (see on page 229).

Minimum moment of inertia / minimum load

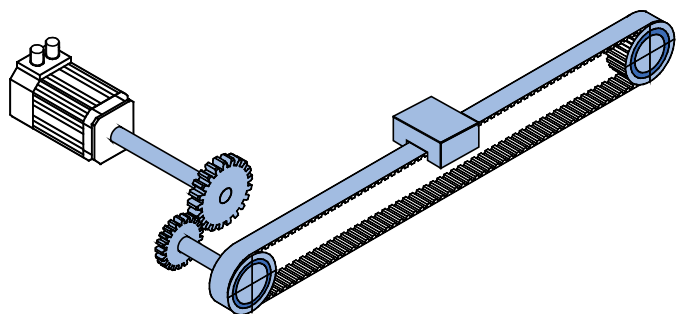

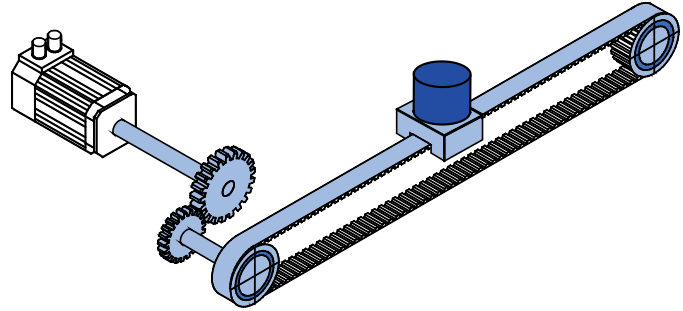
Maximum moment of inertia / maximum load

Enter minimum = maximum moment of inertia when the load does not vary.

4.1.6. Defining the reference system

The reference system for positioning is defined by:

- ◆ a unit,
- ◆ the travel distance per motor revolution,
- ◆ a machine zero point with true zero,
- ◆ positive and negative end limits.

4.1.6.1 Measure reference

In this chapter you can read about:

You can select from among the following for the unit:

- Unit**
- ◆ mm,
 - ◆ increments *
 - ◆ angle degrees or
 - ◆ Inch.

The unit of measure is always [mm] for linear motors.

*

The unit "increments" is valid only for position values!

Speed, acceleration and jerk are specified in this case in revolutions/s, revolutions/s² and revolutions/s³ (resp. pitch/s, pitch/s², pitch/s³ for linear motors).

**Travel distance per
motor revolution /
pitch**

The measure reference to the motor is created with the value:
"travel distance per motor revolution / pitch" in the selected unit.

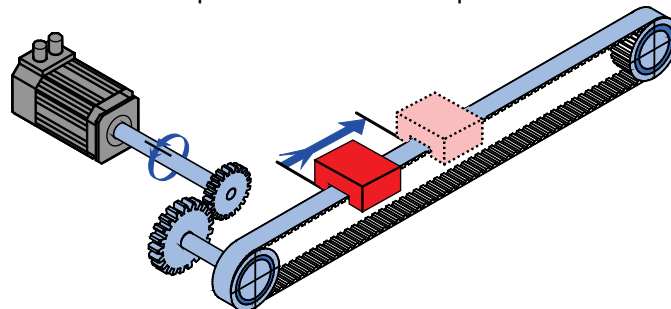

Input as numerator and denominator

You can enter the "travel distance per motor revolution" as a fraction (numerator divided by denominator). This is useful in the case of continuous operation mode or in reset mode if the value cannot be specified as a rational number. Long term drifts can be avoided by integer numerators and denominators.

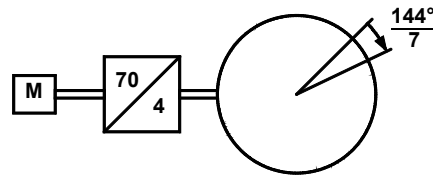
Example 1:**Rotary table control**

Unit: Grade

Gear transmission ratio 70:4 => 4 load revolutions = 70 motor revolutions

Travel distance per motor revolution = $4/70 * 360^\circ = 20.571\ 428\ 5 \dots^\circ$ (number cannot be represented exactly)

Instead of this number, you have the option of entering it exactly as a numerator and denominator:

Travel distance per motor revolution = $144/7$

This will not result in any drift in continuous operation mode or in reset mode, even with relatively long motion in one direction.

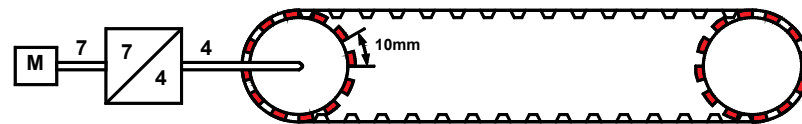
Example 2:**Conveyor belt**

Unit: mm

Gear transmission ratio 7:4 => 4 load revolutions = 7 motor revolutions

Number of pinions: 12

Tooth separation: 10mm

Travel path per motor revolution = $4/7 * 12 * 10\text{mm} = 68.571\ 428\ 5 \dots\ \text{mm}$ (this number cannot be expressed exactly)

Instead of this number, you have the option of entering it exactly as a numerator and denominator:

Travel distance per motor revolution = $480/7\ \text{mm}$

For "travel distance per motor revolution" that can be represented exactly, enter 1 as the denominator.

Travel distance per motor revolution /-pitch

Numerator

Unit: Unit	Range: depends on the unit selected	Standard value: depends on the unit selected
Resolution: 0.000 000 1 (7 decimal places)		
Unit	Division	Standard value
Increments*	10 ... 1 000 000	1024
mm	0.010 000 0 ... 2000.000 000 0	1.000 000 0
Grade	0.010 000 0 ... 720.000 000 0	360.000 000 0
Inch	0.010 000 .. 2000.000 000	1.000 000

Denominator

Unit: -	Range: 1 ... 1 000 000	Standard value: 1
Integer value		

*

The unit "increments" is valid only for position values!

Speed, acceleration and jerk are specified in this case in revolutions/s, revolutions/s² and revolutions/s³ (resp. pitch/s, pitch/s², pitch/s³ for linear motors).

Invert Motor Rotation/Direction Polarity

Unit: -	Range: no / yes	Standard value: no
Reverse direction inverts the sense of rotation, i.e. the direction of movement of the motor is reversed in the case of equal setpoint.		

Reset mode

Reset mode is available for applications in which the positioning range repeats; some examples are: Rotary table applications, belt conveyor. ... After the reset travel distance (exactly specifiable as **numerator and denominator** (see on page 100)) the position values in Compax3 are reset to 0.

Example:

Conveyor belt (from the "Conveyor belt" example) with reset path

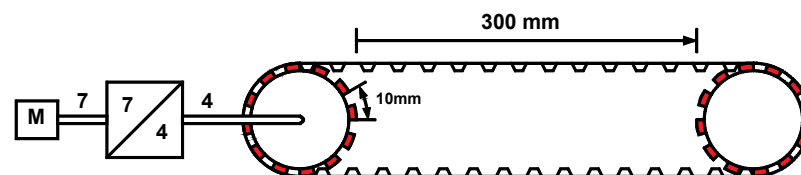

A reset path of 300 mm can be entered directly with numerator = 300 mm and denominator = 1.

Reset mode is not possible for linear motors.

Reset distance

Numerator

Unit: Unit	Range: depends on the unit selected	Standard value: depends on the unit selected
Unit	Division	Standard value
Increments	10 ... 1 000 000	0
mm	1 ... 2000	0
Grade	1 ... 720	0

Denominator

Unit: -	Range: 1 ... 1 000 000	Standard value: 0
Integer value		

Turn off reset mode

Reset mode is turned off for numerator = 0 and denominator = 0.

4.1.6.2 Machine Zero

The Compax3 machine zero modes are adapted to the CANopen profile for Motion Control CiADS402.

Position reference point

Essentially, you can select between operation with or without machine reference. The reference point for positioning is determined by using the machine reference and the machine reference offset.

Machine reference run

In a homing run the drive **normally** (see on page 103) moves to the position value 0 immediately after finding the home switch. The position value 0 is defined via the homing offset.

A machine reference run is required each time after turning on the system for operation with machine reference.

Please note:

During homing run the software end limits are not monitored.



In this chapter you can read about:

Positioning after homing run	103
Absolute encoder.....	104
Operation with MultiTurn emulation	105
Store absolute position in the feedback	105
Machine zero modes overview.....	106
Homing modes with home switch (on X12/14)	108
Machine zero modes without home switch.....	114
Adjusting the machine zero proximity switch.....	118
Machine zero speed and acceleration.....	119

Positioning after homing run

The positioning made after the home switch has been found can be switched off. For this enter in the “machine zero” window in the configuration wizard “no” under “approach MN point after MN run”.

Example Homing (MN) mode 20 (Home on homing (MN) switch) with T40 by homing offset 0

With positioning after homing run The motor stands then on 0:

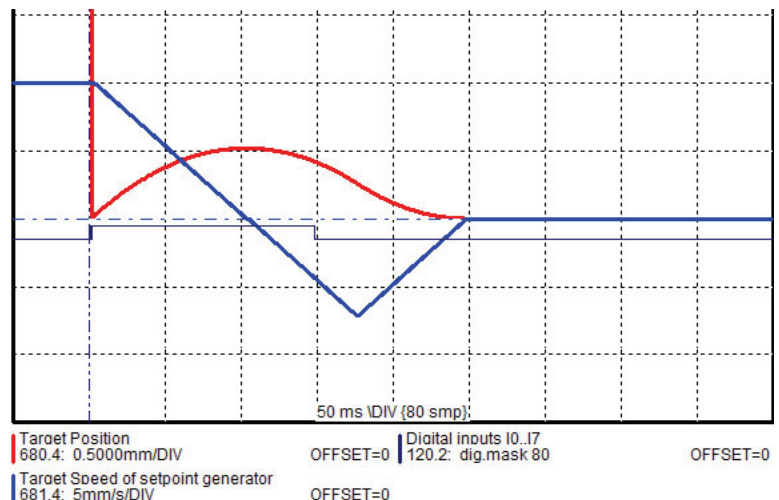

Without positioning after homing run The position reached is not exactly on 0, as the drive brakes when detecting the home and stops:

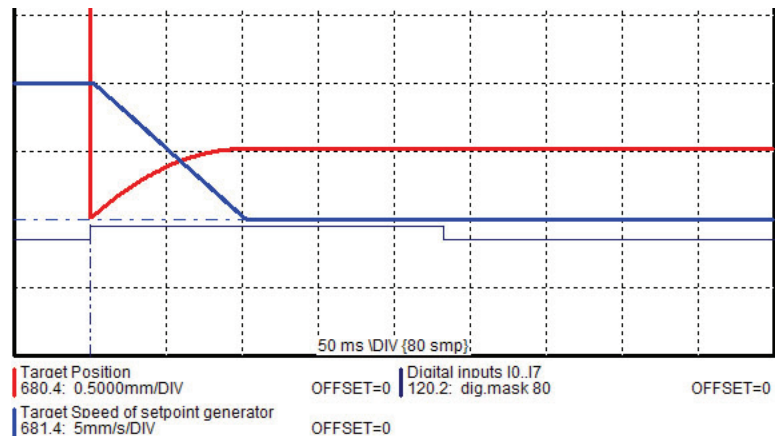

If the homing mode is active, there will always be a homing run with the first start after each configuration download (with the aid of the C3 ServoManager) **Homing run** (see on page 137).

Absolute encoder

Using a SinCos® or EnDat Multiturn absolute value sensor as feedback system, the absolute position can be read in over the entire travel range when switching on the Compax3. This means that a machine zero run is not necessary after the switching on (feedback may not be shifted by the absolute range while switched off).

In this case the reference only needs to be established once

- ◆ at initial commissioning time
- ◆ after an exchange of motor / feedback system
- ◆ after a mechanical modification and
- ◆ after an exchange of device (Compax3); does not apply for the "Store absolute position in feedback" function.
- ◆ after a configuration download by carrying out a machine zero run.

The homing mode 35 "**MN at the current position**" (see on page 114)" is appropriate for this, because it is therewith possible to operate without proximity switch, but any other homing mode is possible too - if the hardware prerequisites are fulfilled.

When you have once re-established the reference, reset the machine zero run mode to "without machine zero run".

Operation with MultiTurn emulation

You can simulate the function of a Multiturn over the entire travel distance by the aid of a Multiturn emulation. A resolver or a SinCos® / EnDat Singleturn feedback is sufficient as a feedback signal from the motor.

It differs from the physical Multiturn in the way that the motor may not be moved by more than half a turn if Compax3 (24VDC) is switched off - unless the absolute position is lost.

Besides that, the Multiturn emulation offers the same function as the physical Multiturn feedback.

You can switch on the Multiturn emulation directly in the wizard.

You can assign the maximum permissible motor angle via the Multiturn validity window

If Compax3 states after switching on that this value is not exceeded, then das "Referenziert" gesetzt (Zustandswort Bit 12 oder Ausgang M.A8) is applied.

Compax3 restores nevertheless the absolute position, the motor angle is correct, the absolute position may however not be correct, if the motor was moved by more than the validity window while currentless.

Attention: In this case, the drive is considered "not referenced" and the software end limit monitoring is inactive!

Machine reference run For a unique machine zero run the same conditions apply as for the use of an absolute encoder (Multiturn).

Store absolute position in the feedback

With SinCos® or EnDat feedback systems, the absolute position can be memorized in the feedback; therefore the Compax3 device can be exchanged without loss of position.

The function is possible with Multiturn absolute value feedback systems and in combination with the "Multiturn emulation" function and is activated by selecting "Store absolute position: in the position feedback" (Configuration wizard: Reference system).

The standard setting valid up to now is "Store absolute position: in the device".

Read / write position value

The writing process into the position feedback takes place upon a successful machine zero run.

After PowerOn of Compax3, the position value of the position feedback is read out.

Please note:

- ◆ Other data stored in the feedback are overwritten!
- ◆ The motor may not move away from the homing position by more than +/-2048 revolutions (motor position upon completed homing mode), otherwise, the motor position will be lost after PowerOff/On (->endless instructions with only one travel direction or with one stroke bigger than 2048 motor revolutions are not permitted in this operating mode)!

Machine zero modes overview

Selection of the machine zero modes (MN-M)

Machine home switch on X12/14: MN-M 3 ... 14, 19 ... 30	Without motor reference point MN-M 19 ...30	without direction reversal switches: MN-M 19, 20 (see on page 108), MN-M 21, 22 (see on page 109) with reversal switches: MN-M 23, 24, 25, 26 (see on page 110), MN-M 27, 28, 29, 30 (see on page 110)
	With motor reference point MN-M 3 ... 14 (possibly an initiator adjustment (see on page 118) is required)	without direction reversal switches: MN-M 3, 4 (see on page 111), MN-M 5, 6 (see on page 112) with reversal switches: MN-M 7, 8, 9, 10 (see on page 113), MN-M 11,12,13, 14 (see on page 113)
Without machine zero initiator on X12/14: MN-M 1, 2, 17, 18, 33 .. 35, 128, 129, 130 ... 133	Without motor reference point MN-M 17, 18, 35, 128, 129	MN-M 35: on the actual position (see on page 114) MN-M 128, 129: by moving to block (see on page 114)
		With limit switch as machine zero: MN-M 17, 18 (see on page 115)
		Only motor reference: MN-M 33, 34 (see on page 116), MN-M 130, 131 (see on page 116)
		With limit switch as machine zero: MN-M 1, 2 (see on page 117), MN-M 132, 133 (see on page 118)

Definition of terms / explanations:

Motor zero point	Zero pulse of the feedback Motor feedback systems such as resolvers or SinCos® / EnDat give one pulse per revolution. Some motor feedback systems of direct drives do also have a zero pulse, which is generated once or in defined intervals. By interpreting the motor zero point (generally in connection with the machine zero initiator) the machine zero can be defined more exactly.
Machine zero initiator:	For creating the mechanical reference Has a defined position within or on the edge of the travel range.
Direction reversal switches:	Initiators on the edge of the travel range, which are used only with a machine zero run in order to detect the end of the travel range. In some cases, the function "direction reversal via Stromschwelle" is also possible, then you will need no initiator, Compax3 detects the end of the travel range via the threshold. Please observe the respective notes. During operation, the direction reversal switches are often used as limit switches.

Example axis with the initiator signals

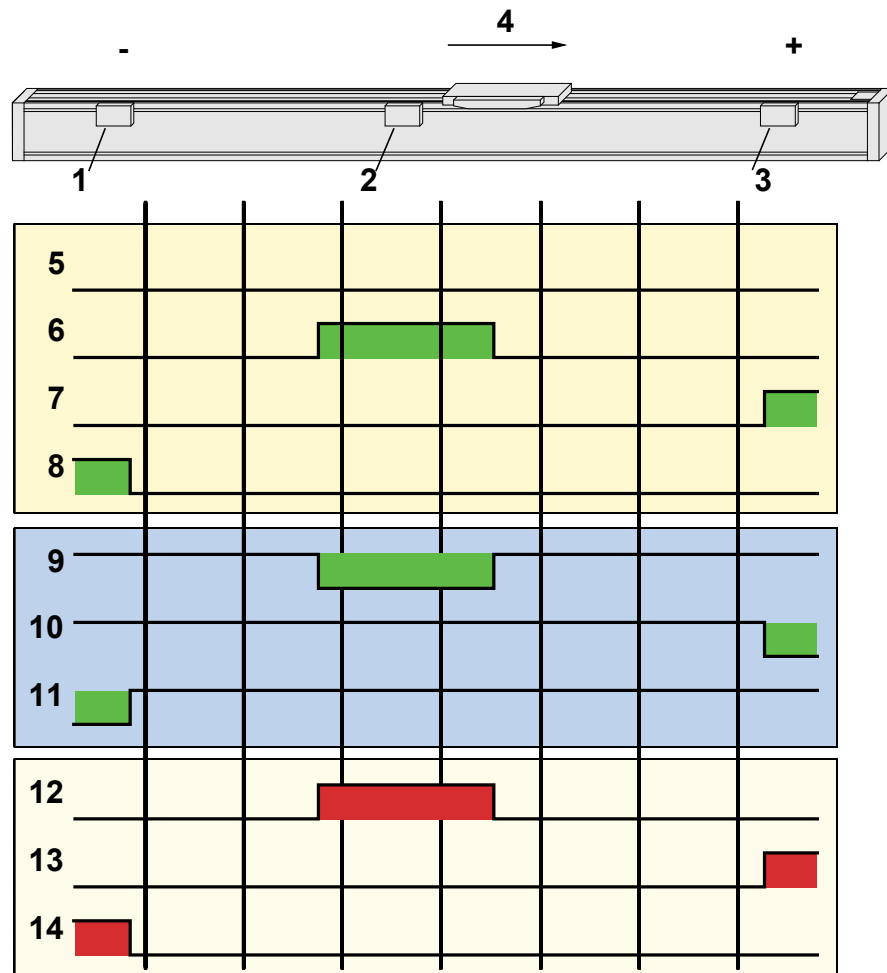

- 1: Direction reversal / end switch on the negative end of the travel range (the **assignment of the reversal / end switch inputs** (see on page 123) to travel range side can be changed).
- 2: Machine zero initiator (can, in this example, be released to 2 sides)
- 3: Direction reversal / end switch on the positive end of the travel range (the **assignment of the reversal / end switch inputs** (see on page 123) to travel range side can be changed).
- 4: Positive direction of movement
- 5: Signals of the motor zero point (zero pulse of the motor feedback)
- 6: Signal of the machine zero initiator (**without inversion of the initiator logic** (see on page 123)).
- 7: Signal of the direction reversal resp. end switch on the positive end of the travel range (without inversion of the initiator logic).
- 8: Signal of the direction reversal / resp. end switch on the negative end of the travel range (without inversion of the initiator logic).
- 9: Signal of the machine zero initiator (**with inversion of the initiator logic** (see on page 123)).
- 10: Signal of the direction reversal resp. end switch on the positive end of the travel range (with inversion of the initiator logic).
- 11: Signal of the direction reversal / end switch on the negative end of the travel range (with inversion of the initiator logic).
- 12: Logic state of the home switch (independent of the inversion)
- 13: Logic state of the direction reversal resp. end switch on the positive end of the travel range (independent of the inversion)
- 14: Logic state of the direction reversal resp. end switch on the negative end of the travel range (independent of the inversion)

The following principle images of the individual machine zero modes always refer to the logic state (12, 13, 14) of the switches.

Homing modes with home switch (on X12/14)

In this chapter you can read about:

Without motor reference point..... 108
 With motor reference point..... 111

Without motor reference point

In this chapter you can read about:

Without direction reversal switches..... 108
 With direction reversal switches..... 109

Without direction reversal switches

MN-M 19,20: MN-Initiator = 1 on the positive side

The MN initiator can be positioned at any location within the travel range. The travel range is then divided into 2 contiguous ranges: one range with deactivated MN initiator (left of the MN initiator) and one range with activated MN initiator (right of the MN initiator).

When the MN initiator is inactive (signal = 0) the search for the machine reference is in the positive travel direction.

Without motor zero point, without direction reversal switches

MN-M 19: The negative edge of the MN proximity switch is taken directly as MN (the motor zero point remains without consideration).

MN-M 20: The positive edge of the MN proximity switch is used directly as MN (the motor zero point remains without consideration).

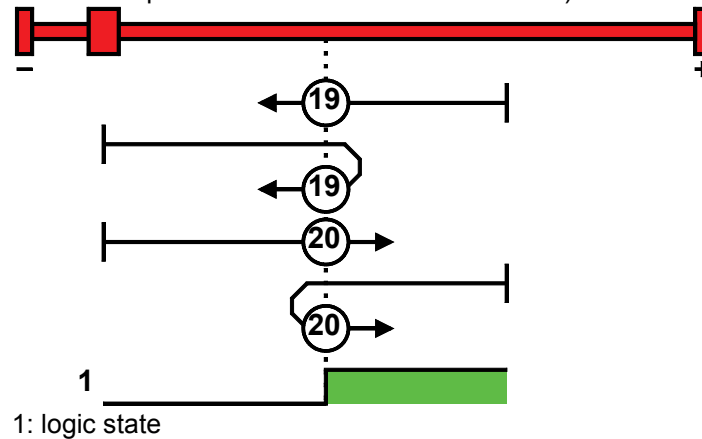

MN-M 21,22: MN Initiator = 1 on the negative side

The MN initiator can be positioned at any location within the travel range. The travel range is then divided into 2 contiguous ranges: one range with deactivated MN initiator (positive part of the travel range) and one range with activated MN initiator (negative part of the travel range).

When the MN initiator is inactive (signal = 0) the search for the machine reference is in the negative travel direction.

Without motor zero point, without direction reversal switches

MN-M 21: The negative edge of the MN proximity switch is taken directly as MN (the motor zero point remains without consideration).

MN-M 22: The positive edge of the MN proximity switch is used directly as MN (the motor zero point remains without consideration).

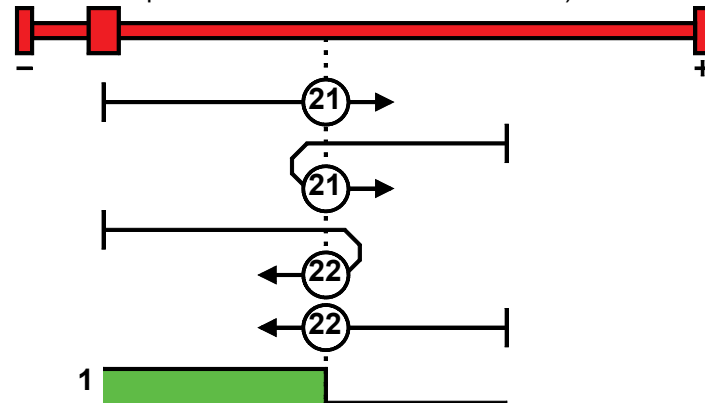

1: logic state

With direction reversal switches

Machine zero modes with a home switch which is activated in the middle of the travel range and can be deactivated to both sides.

The **assignment of the direction reversal switches** (see on page 123) can be changed.

Function Reversal via Stromschwelle

If no direction reversal switches are available, the reversal of direction can also be performed during the machine zero run via the function “direction reversal via Stromschwelle”.

The drive drives against the mechanical end stop.

When the adjustable Stromschwelle is reached, the drive is decelerated and changes the direction of movement.

**Caution!**

Wrong settings can cause hazard for man and machine.

It is therefore essential to respect the following:

- ◆ Choose a low machine zero speed.
- ◆ Set the machine zero acceleration to a high value, so that the drive changes direction quickly, the value must, however, not be so high that the limit threshold is already reached by accelerating or decelerating (without mechanical limitation).
- ◆ The mechanical limitation as well as the load drain must be set so that they can absorb the resulting kinetic energy.
- ◆ With a bad feedback signal or high controller gain (fast controller or high inertia or mass) the machine zero might not be detected.

In this case it is necessary to use the control signal filter (O2100.20) or the velocity filter (O2100.10).

MN-M 23...26: Direction reversal switches on the positive side

Without motor zero point, with direction reversal switches

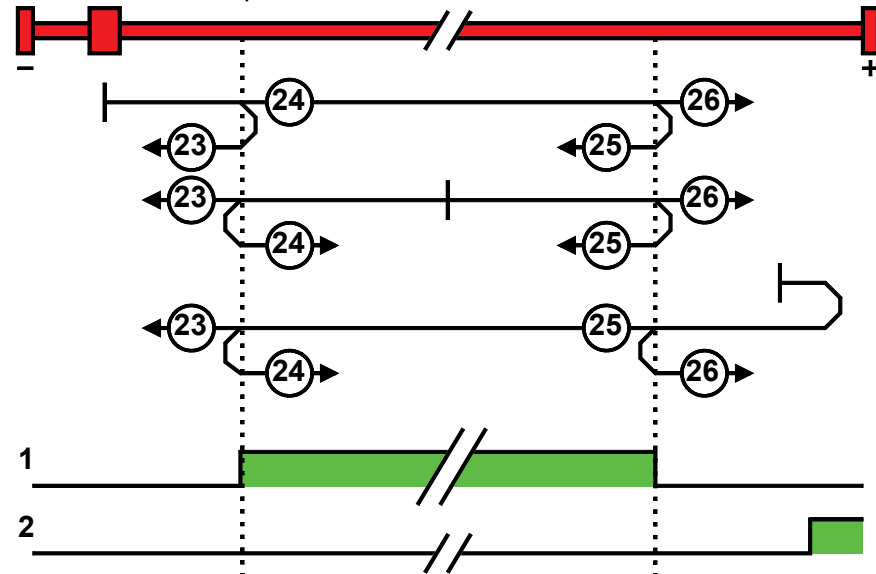

- 1: Logic state of the home switch
- 2: Logic state of the direction reversal switch

MN-M 27...30: Direction reversal switches on the negative side

Without motor zero point, with direction reversal switches

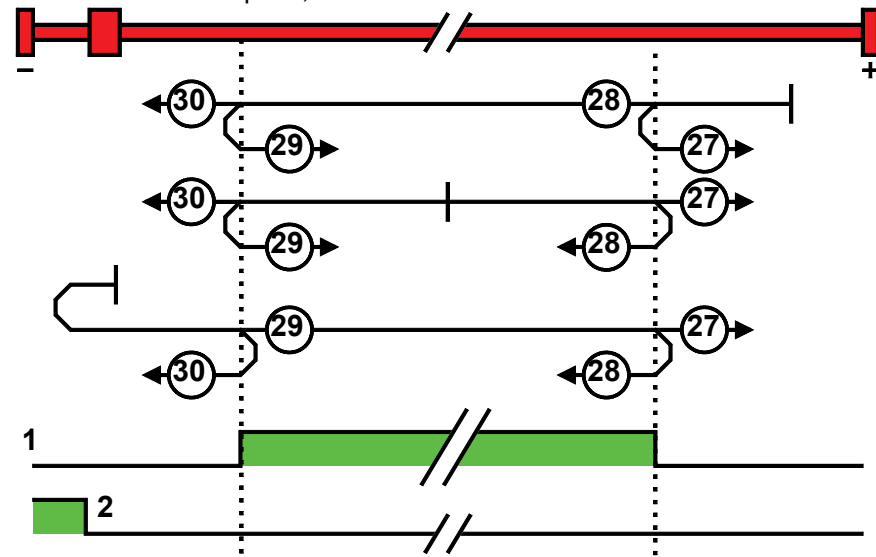

- 1: Logic state of the home switch
- 2: Logic state of the direction reversal switch

With motor reference point

In this chapter you can read about:

Without direction reversal switches 111
 With direction reversal switches 112

Without direction reversal switches

MN-M 3,4: MN-Initiator = 1 on the positive side

The MN initiator can be positioned at any location within the travel range. The travel range is then divided into 2 contiguous ranges: one range with deactivated MN initiator (left of the MN initiator) and one range with activated MN initiator (right of the MN initiator).

When the MN initiator is inactive (signal = 0) the search for the machine reference is in the positive travel direction.

With motor zero point, without direction reversal switches

MN-M 3: The 1st motor zero point at MN initiator = "0" is used as MN.

MN-M 4: The 1st motor reference point with MN initiator = "1" is used as the MN.

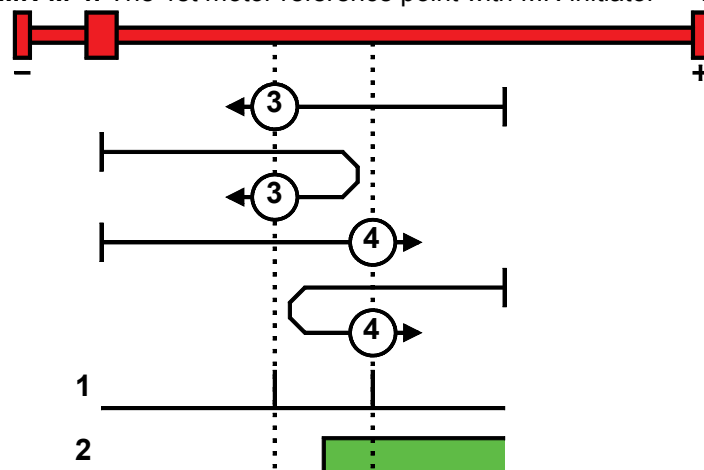

1: Motor zero point
 2: Logic state of the home switch

MN-M 5,6: MN Initiator = 1 on the negative side

The MN initiator can be positioned at any location within the travel range. The travel range is then divided into 2 continuous ranges: one range with deactivated MN initiator (positive part of the travel range) and one range with activated MN initiator (negative part of the travel range).

When the MN initiator is inactive (signal = 0) the search for the machine reference is in the negative travel direction.

**With motor zero point,
without direction
reversal switches**

MN-M 5: The 1st motor reference point with MN initiator = "0" is used as the MN.
MN-M 6: The 1st motor reference point with MN initiator = "1" is used as the MN.

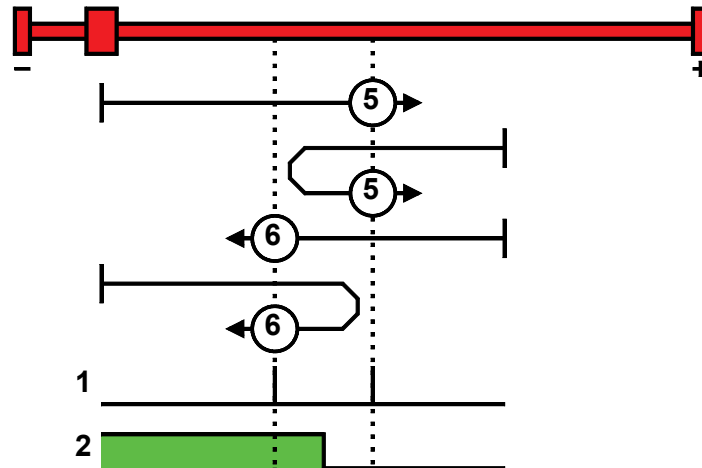

1: Motor zero point
2: Logic state of the home switch

With direction reversal switches

Machine zero modes with a home switch which is activated in the middle of the travel range and can be deactivated to both sides.

The **assignment of the direction reversal switches** (see on page 123) can be changed.

Function Reversal via Stromschwelle

If no direction reversal switches are available, the reversal of direction can also be performed during the machine zero run via the function "direction reversal via Stromschwelle".

The drive drives against the mechanical end stop.

When the adjustable Stromschwelle is reached, the drive is decelerated and changes the direction of movement.

**Caution!**

Wrong settings can cause hazard for man and machine.

It is therefore essential to respect the following:

- ◆ Choose a low machine zero speed.
- ◆ Set the machine zero acceleration to a high value, so that the drive changes direction quickly, the value must, however, not be so high that the limit threshold is already reached by accelerating or decelerating (without mechanical limitation).
- ◆ The mechanical limitation as well as the load drain must be set so that they can absorb the resulting kinetic energy.
- ◆ With a bad feedback signal or high controller gain (fast controller or high inertia or mass) the machine zero might not be detected.
In this case it is necessary to use the control signal filter (O2100.20) or the velocity filter (O2100.10).

With motor zero point, with direction reversal switches

MN-M 7...10: Direction reversal switches on the positive side

Machine zero modes with a home switch which is activated in the middle of the travel range and can be deactivated to both sides.

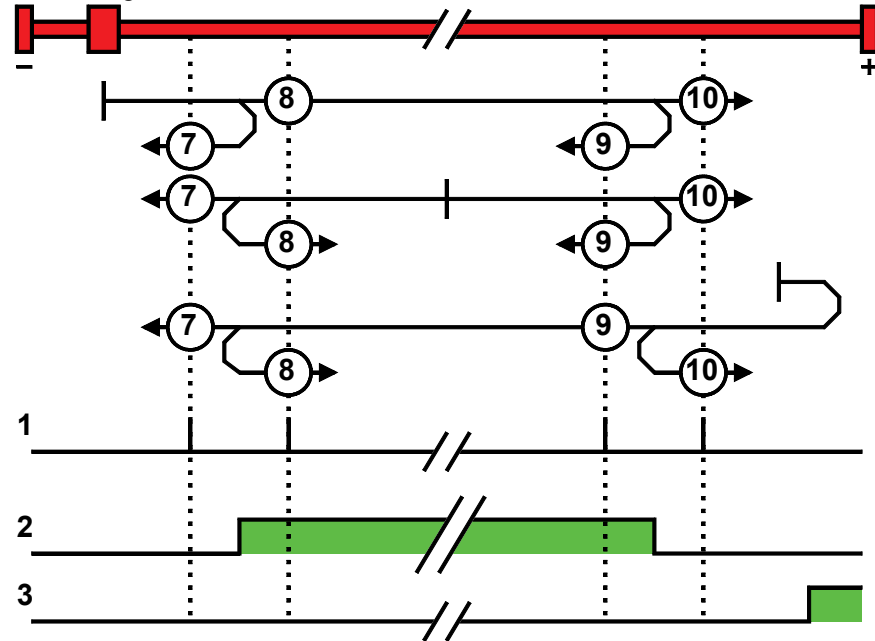

- 1: Motor zero point
- 2: Logic state of the home switch
- 3: Logic state of the direction reversal switch

With motor zero point, with direction reversal switches

MN-M 11...14: With direction reversal switches on the negative side

Machine zero modes with a home switch which is activated in the middle of the travel range and can be deactivated to both sides.

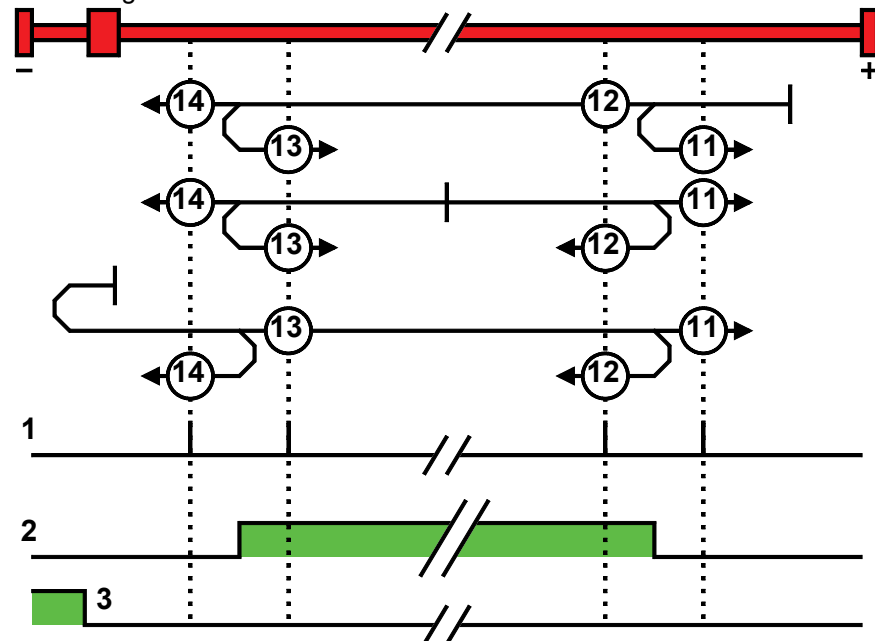

- 1: Motor zero point
- 2: Logic state of the home switch
- 3: Logic state of the direction reversal switch

Machine zero modes without home switch

In this chapter you can read about:

Without motor reference point..... 114
 With motor reference point..... 116

Without motor reference point

MN-M 35: MN (machine zero) at the current position

The current position when the MN run is activated is used as an MN.

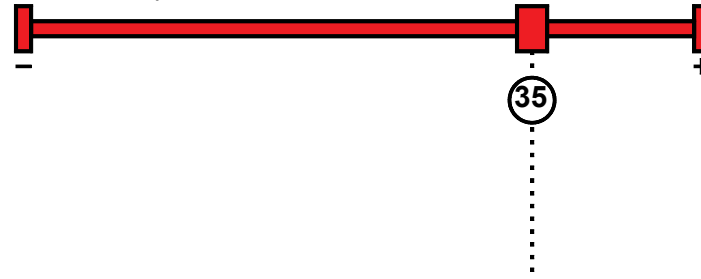

Please note: Due to encoder noise it is possible that a value $\neq 0$ is set when teaching to 0. If end limits = 0, an end limit error may occur during homing run.

MN-M 128/129: Stromschwelle while moving to block

Without a MN (machine zero) initiator, an end of travel region (block) is used as MN (machine zero).

For this the Stromschwelle is evaluated if the drive pushes against the end of the travel region. When the adjusted current is exceeded, the Homing is set. During the homing run (MN), the error reaction "following error" is deactivated.

Please observe:

The machine zero offset must be set so that the zero point (reference point) for positioning lies within the travel range.

MN-M 128: Travel in the positive direction to the end of the travel region



MN-M 129: Travel in the negative direction to the end of the travel region



	<p>Caution! Wrong settings can cause hazard for man and machine.</p>
---	---

It is therefore essential to respect the following:

- ◆ Choose a low machine zero speed.
- ◆ Set the machine zero acceleration to a high value, so that the drive changes direction quickly, the value must, however, not be so high that the limit threshold is already reached by accelerating or decelerating (without mechanical limitation).
- ◆ The mechanical limitation as well as the load drain must be set so that they can absorb the resulting kinetic energy.
- ◆ With a bad feedback signal or high controller gain (fast controller or high inertia or mass) the machine zero might not be detected.
In this case it is necessary to use the control signal filter (O2100.20) or the velocity filter (O2100.10).

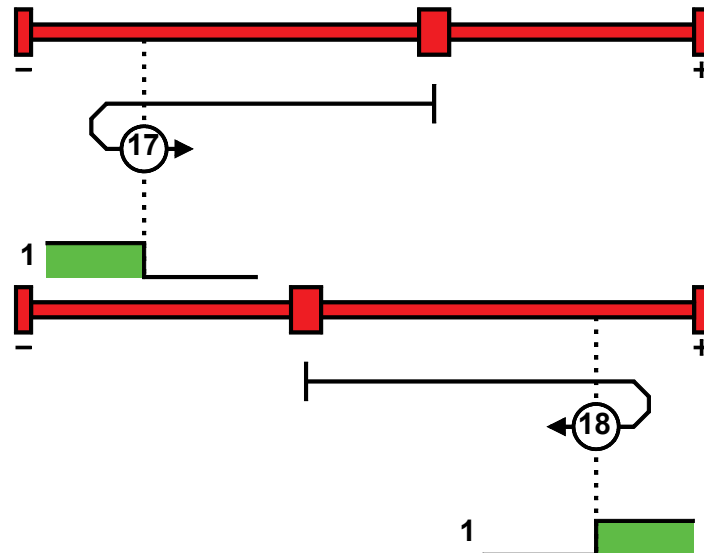
MN-M 17,18: Limit switch as machine zero

1: Logic state of the direction reversal switch

Function Reversal via Stromschwelle

If no direction reversal switches are available, the reversal of direction can also be performed during the machine zero run via the function “direction reversal via Stromschwelle”.

The drive drives against the mechanical end stop.

When the adjustable Stromschwelle is reached, the drive is decelerated and changes the direction of movement.

**Caution!**

Wrong settings can cause hazard for man and machine.

It is therefore essential to respect the following:

- ◆ Choose a low machine zero speed.
- ◆ Set the machine zero acceleration to a high value, so that the drive changes direction quickly, the value must, however, not be so high that the limit threshold is already reached by accelerating or decelerating (without mechanical limitation).
- ◆ The mechanical limitation as well as the load drain must be set so that they can absorb the resulting kinetic energy.
- ◆ With a bad feedback signal or high controller gain (fast controller or high inertia or mass) the machine zero might not be detected.
In this case it is necessary to use the control signal filter (O2100.20) or the velocity filter (O2100.10).

With motor reference point

In this chapter you can read about:

Machine zero only from motor reference..... 116
 With direction reversal switches..... 117

Machine zero only from motor reference

MN-M 33,34: MN at motor zero point

The motor reference point is now evaluated (no MN initiator):

Without home switch

MN-M 33: For a MN run, starting from the current position, the next motor zero point in the negative travel direction is taken as the MN.

MN-M 34: For a MN run, starting from the current position, the next motor zero point in the positive travel direction is taken as the MN.

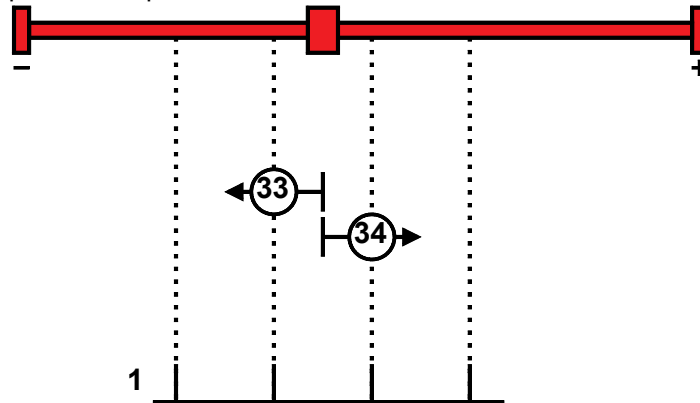

1: Motor zero point

MN-M 130, 131: Acquire absolute position via distance coding

Only for motor feedback with distance coding (the absolute position can be determined via the distance value).

Compax3 determines the absolute position from the distance of two signals and then stops the movement (does not automatically move to position 0).



1: Signals of the distance coding

With direction reversal switches

Machine zero modes with a home switch which is activated in the middle of the travel range and can be deactivated to both sides.

The **assignment of the direction reversal switches** (see on page 123) can be changed.

Function Reversal via Stromschwelle

If no direction reversal switches are available, the reversal of direction can also be performed during the machine zero run via the function “direction reversal via Stromschwelle”.

The drive drives against the mechanical end stop.

When the adjustable Stromschwelle is reached, the drive is decelerated and changes the direction of movement.

	<p>Caution! Wrong settings can cause hazard for man and machine.</p>
---	---

It is therefore essential to respect the following:

- ◆ Choose a low machine zero speed.
- ◆ Set the machine zero acceleration to a high value, so that the drive changes direction quickly, the value must, however, not be so high that the limit threshold is already reached by accelerating or decelerating (without mechanical limitation).
- ◆ The mechanical limitation as well as the load drain must be set so that they can absorb the resulting kinetic energy.
- ◆ With a bad feedback signal or high controller gain (fast controller or high inertia or mass) the machine zero might not be detected.
In this case it is necessary to use the control signal filter (O2100.20) or the velocity filter (O2100.10).

MN-M 1,2: Limit switch as machine zero

End switch on the negative side

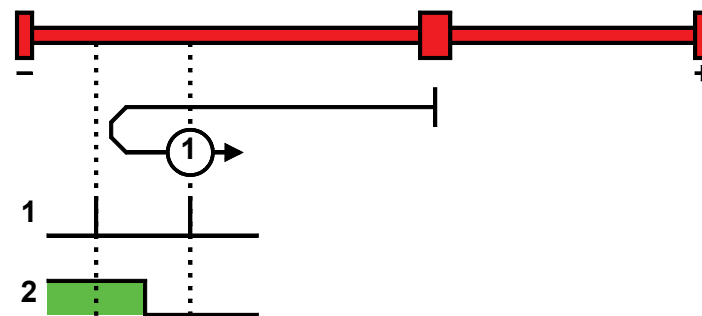

1: Motor zero point
2: Logic state of the direction reversal switch

End switch on the positive side:

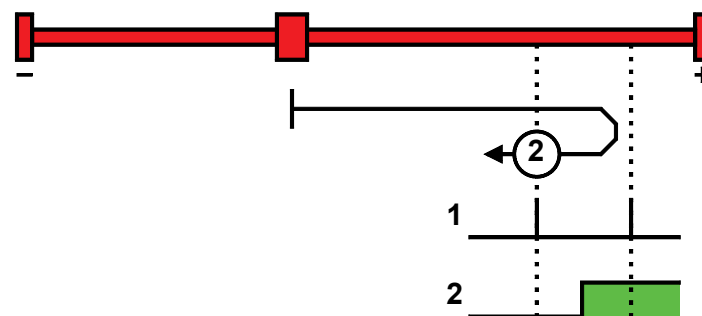

1: Motor zero point
2: Logic state of the direction reversal switch

MN-M 132, 133: Determine absolute position via distance coding with direction reversal switches

Only for motor feedback with distance coding (the absolute position can be determined via the distance value).

Compax3 determines the absolute position from the distance of two signals and then stops the movement (does not automatically move to position 0).

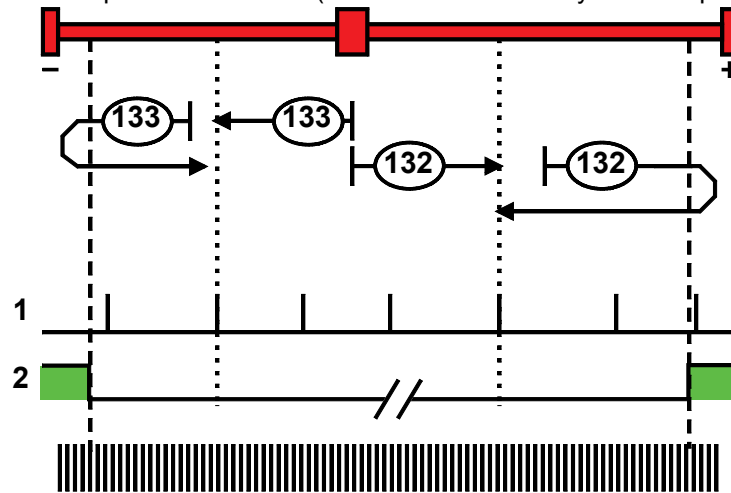

1: Signals of the distance coding
2: Logic state of the direction reversal switches

Adjusting the machine zero proximity switch

This is helpful in some cases with homing modes that work with the home switch and motor reference point.

If the motor reference point happens to coincide with the position of the MN initiator, there is a possibility that small movements in the motor position will cause the machine reference point to shift by one motor revolution (to the next motor reference point).

Via status value "Distance MN sensor - motor zero", (O1130.13) you can check if the distance between machine home sensor and motor zero point is too short.

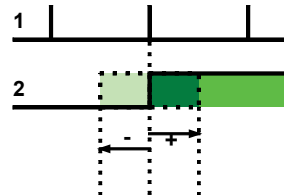

1: Motor zero point
2: Logic state of the home switch

A solution to this problem is to move the MN initiator by means of software. This is done using the value initiator adjustment.

Initiator adjustment

Unit: Motor angle in degrees	Range: -180 ... 180	Standard value: 0
Move the machine reference initiator using software As an aid you can use the status value "distance MN sensor - motor zero" in the "Positions" chapter under "status values"		

Machine reference offset

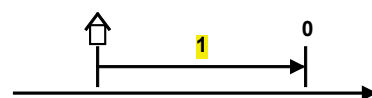

1: Machine reference offset

The machine reference offset is used to determine the actual reference point for positioning.

That is: Zero point = Machine zero + Machine zero offset

Note: If the machine zero proximity switch is at the positive end of the travel range, the machine zero offset must be = 0 or negative.

A change in the machine reference offset does not take effect until the next machine reference run.

Machine zero speed and acceleration

With these values you can define the motion profile of the machine zero run.

4.1.6.3 Travel Limit Settings

Software end limits

The error reaction when reaching the software end limits can be set:
Possible settings for the error reaction are:

- ◆ No response
- ◆ Downramp / stop
- ◆ Downramp / stromlos schalten (standard settings)

If "no reaction" was set, no software limits must be entered.

Software end limits:

The travel range is defined via the negative and positive end limits.

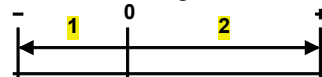

- 1: negative end limit
2: positive end limit

Software end limit in absolute operating mode

The positioning is restricted to the range between the travel limits.
A positioning order aiming at a target outside the travel range is not executed.

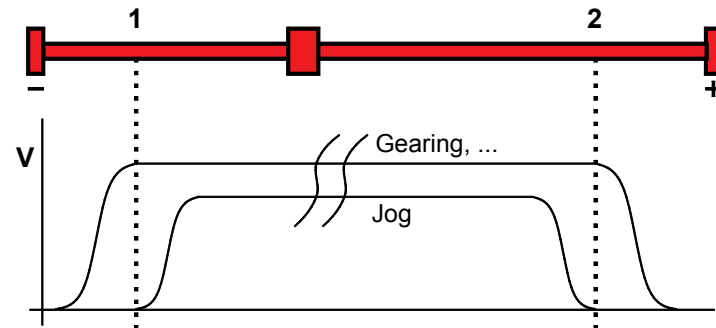

- 1: negative end limit
2: positive end limit

The reference is the position reference point that was defined with the machine reference and the machine reference offset.

Software end limits in reset mode

The reset mode does not support software end limits

Software end limit in continuous mode

Each individual positioning is confined within the travel limits.
 A positioning order aiming at a target outside the software end limits is not executed.
 The reference is the respective current position.

Error when disregarding the software end limits

A software end limit error is triggered, if the position value exceeds an end limit.
 For this, the position setpoint value is evaluated in energized state; in currentless state, the actual position value is evaluated.

Hysteresis in disabled state:

If the axis stands currentless at an end limit, another error may be reported due to position jitter after acknowledging the end limit error. To avoid this, a hysteresis surrounding the end limits was integrated (size corresponds to the size of the positioning window).
 Only if the distance between axis and the end limits was larger than the positioning window, another end limit error will be detected

Error codes (see on page 301) of the end limit errors:

- 0x7323 Error when disregarding the positive software end limit.
- 0x7324 Error when disregarding the negative software end limit.

Activating / deactivating the end limit error:

In the C3 ServoManager under configuration: End limits, the error can be (de)activated.
 For IEC-programmable devices with the "C3_ErrorMask" module.

Behavior after the system is turned on

The end limits are not active after switching on. The end limits do not refer to the position reference point until after a machine reference run.
 During homing run the end limits are not monitored.
 With a Multiturn encoder or with active Multiturn emulation, the limit is valid immediately after switching on.

Behavior outside the travel range

1. If the software end limit errors are deactivated, all movements are possible.

2. If the software end limit errors are activated:

After disregarding the software end limits, an error is triggered. First of all, this error must be acknowledged.
 Then a direction block is activated: only motion commands in the direction of the travel range are executed. These will not trigger another error.
 Motion commands inciting a movement in the opposite direction of the travel range are blocked and will trigger another error.

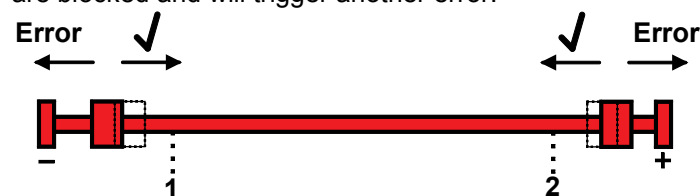

- 1: negative end limit
- 2: positive end limit

Notes on special feedback systems (Feedback F12)

During automatic commutation, the end limit monitoring is deactivated!

Behavior with software end limits of a referenced axis

	Position within target outside	Position outside target outside and aiming in the opposite direction of the travel range	Position outside target within and aiming in the direction of the travel range
JOG +/-	<ul style="list-style-type: none"> ◆ Positioning up to the end limits ◆ No Error 	<ul style="list-style-type: none"> ◆ No positioning ◆ No Error 	<ul style="list-style-type: none"> ◆ Positioning
MoveAbs, MoveRel, RegSearch, RegMove	<ul style="list-style-type: none"> ◆ No positioning ◆ Error 	<ul style="list-style-type: none"> ◆ No positioning ◆ Error 	<ul style="list-style-type: none"> ◆ Positioning
Gearing	<ul style="list-style-type: none"> ◆ Positioning up to the end limits ◆ Error 	<ul style="list-style-type: none"> ◆ No positioning ◆ Error 	<ul style="list-style-type: none"> ◆ No positioning ◆ Error
Velocity	<ul style="list-style-type: none"> ◆ Positioning up to the end limits ◆ Error 	<ul style="list-style-type: none"> ◆ No positioning ◆ Error 	<ul style="list-style-type: none"> ◆ Positioning

Hardware end limits

The error reaction when reaching the hardware end limits can be set:
Possible settings for the error reaction are:

- ◆ No response
- ◆ Downramp / stop
- ◆ Downramp / stromlos schalten (standard settings)

Hardware end limits are realized with the aid of end switches.

These are connected to X12/12 (input 5) and X12/13 (input 6) and can be (de)activated separately in the C3 ServoManager under Configuration: End limits. After a limit switch has been detected, the drive decelerates with the ramp values set for errors (error code 0x54A0 at X12/12 active, 0x54A1 at X12/13 active) and the motor is switched to currentless.

Please make sure that after the detection of the end switch there is enough travel path left up to the limit stop.

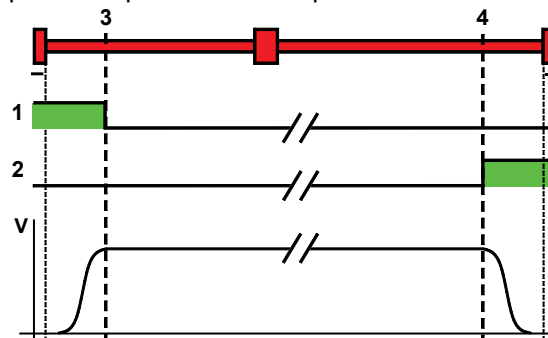

- 1: Limit switch E5 (X12/12)
- 2: Limit switch E6 (X12/13)
- 3: Limit switch position E5 (X12/12)
- 4: Limit switch position E6 (X12/13)

The **assignment of the limit switches** (see on page 123) can be changed!

Please note: The limit switches must be positioned so that they cannot be released towards the side to be limited.

Limit switch / direction reversal switch
Behavior in the case of an active limit switch

Limit switches functioning as direction reversal switches during homing run, will not trigger a limit switch error.

The error can be acknowledged with activated limit switch.
 The drive can then be moved out of the end switch range with a normal positioning.
 The direction of the movement is verified in the event of fixed I/O assignment.
 Only the direction towards the travel range is allowed.

Debouncing: Limit switch, machine zero and input 0

A majority gate is used for debouncing.
 The signal is sampled every 0.5ms
 The debounce time determines the number of scans the majority gate will perform.
 If the level of more than half of the signals was changed, the internal status will change.
 The debounce time can be set in the configuration wizard within the range of 0 ... 20ms.
 The value 0 deactivates the debouncing.

If the debouncing time is stated, the input I0 can be debounced as well (checkbox below).

4.1.6.4 Change assignment direction reversal / limit switches

If this function is not activated, the direction reversal / end switches are assigned as follows:

Direction reversal / limit switch on I5 (X12/12): negative side of the travel range

Direction reversal / limit switch on I6 (X12/13): positive side of the travel range

Change assignment of direction reversal / limit switch is activated

If this function is activated, the direction reversal / limit switches are assigned as follows:

Direction reversal / limit switch on **I5** (X12/12): **positive side** of the travel range
 Direction reversal / limit switch on **I6** (X12/13): **negative side** of the travel range

4.1.6.5 Change initiator logic

The initiator logic of the limit switches (this does also apply for the direction reversal switches) and the machine zero initiator can be changed separately.

- ◆ Limit switch E5 low active
- ◆ Limit switch E6 low active
- ◆ Home switch E7 low active

In the basic settings the inversion is deactivated, so that the signals are "high active".

With this setting the inputs I5 to I7 can even be switched within their logic, if they are not used as direction reversal/limit switches or machine zero.

4.1.7. Defining jerk / ramps

In this chapter you can read about:

Jerk limitation 124
 Ramp upon error / deenergize 125

4.1.7.1 Jerk limitation

Description of jerk

Jerk

The jerk (marked with “4” in the drawing below) describes the change in acceleration (derivation of the acceleration)

The maximum change in acceleration is limited via the jerk limitation. A motion process generally starts from a standstill, accelerates constantly at the specified acceleration to then move at the selected speed to the target position. The drive is brought to a stop before the target position with the delay that has been set in such a manner as to come to a complete stop at the target position. To reach the set acceleration and deceleration, the drive must change the acceleration (from 0 to the set value or from the set value to 0).

This change in speed is limited by the maximum jerk.

Without jerk according to VDI2143

According to VDI2143 the jerk is defined (other than here) as the jump in acceleration (infinite value of the jerk function).

This means that positionings with Compax3 are without jerk according to VDI2143, as the value of the jerk function is limited.

Motion sequence

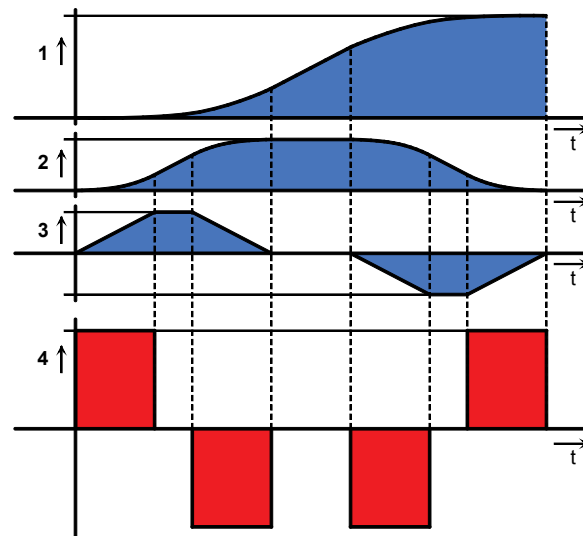

- 1: Position
- 2: Speed
- 3: Acceleration
- 4: Jerk

High changes in acceleration (high jerks) often have negative effects on the mechanical systems involved. There is a danger that mechanical resonance points will be excited or that impacts will be caused by existing mechanical slack points. You can reduce these problems to a minimum by specifying the maximum jerk.

Jerk

Unit: Unit/s ³	Range: 0 ... 10 000 000	Standard value: 1 000 000
---------------------------	-------------------------	------------------------------

STOP delay

After a STOP signal, the drive applies the brakes with the delay that is set (2).

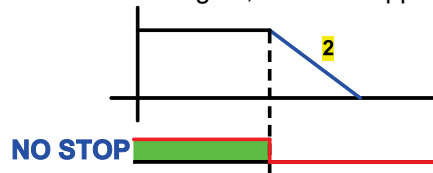

Please observe:

The configured STOP ramp is limited. The STOP ramp will not be smaller than the deceleration set in the last motion set.

NO STOP: no STOP (I1, M.I6, CW.1 or CW.14)

4.1.7.2 Ramp upon error / deenergize

Ramp (delay) upon error and "De-energize"

The same delay is used for "Deenergizing" and when an error appears (errors which do not deenergize immediately).

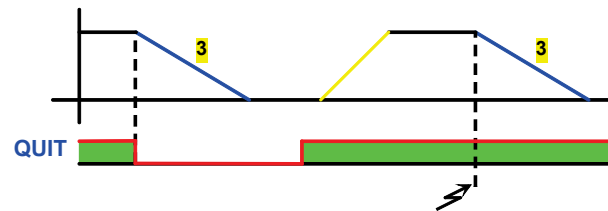

3: Deceleration on "de-energize" and on "error".

Please observe:

The configured error ramp is limited. The error ramp will not be smaller than the deceleration set in the last motion set.

ACKN: I0: Quit or CW.0 (with positive edge)

START: M.E5: START or CW.13 (with positive edge)

Manual acceleration/deceleration and speed control

You can set the motion profile for moving with JOG+ or JOG- here.

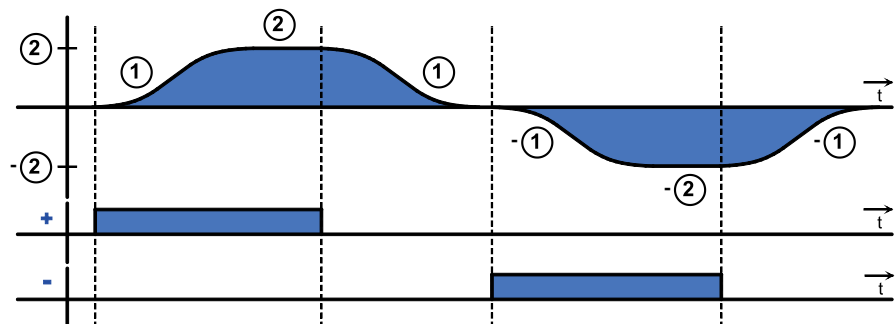

1: Manual acceleration / Deceleration

2: Manual speed control

+: I2: MANUAL+ or CW.2

-: I3: MANUAL- or CW.3

4.1.8. Limit and monitoring settings

In this chapter you can read about:

Current (Torque) Limit	126
Positioning window - Position reached	126
Following error limit	128
Maximum operating speed	128

4.1.8.1 Current (Torque) Limit

The current required by the speed controller is limited to the current limit.

4.1.8.2 Positioning window - Position reached

Position reached indicates that the target position is located within the position window.

In addition to the position window, a position window time is supported. If the actual position goes inside the position window, the position window time is started. If the actual position is still inside the position window after the position window time, "Position reached" is set.

If the actual position leaves the position window within the position window time, the position window time is started again.

When the actual position leaves the position window with Position reached = "1", Position reached is immediately reset to "0".

Position monitoring is active even if the position leaves the position window because of measures taken externally.

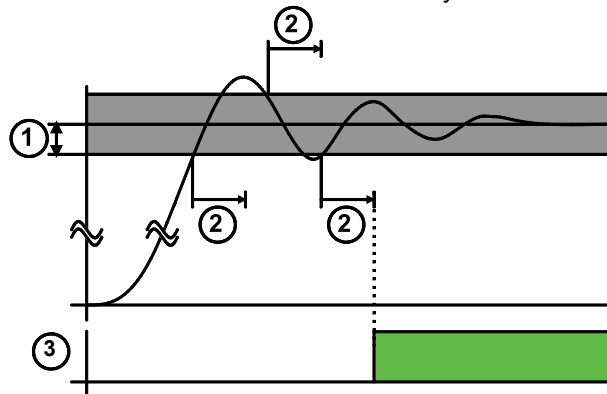

- 1: Position Window
- 2: In Position Window Time
- 3: A1 and SW.9: Position reached

Linkage to the setpoint value

The signal "position reached" can be linked to the setpoint value.

In addition, the internal setpoint value generation is evaluated.

It applies: **The positioning window is only evaluated with a constant internal setpoint value.**

Position reached

Gearitg

Signal "position reached" monitors synchronicity.

RegSearch / RegMove

Signal "position reached" is set if
 ♦ RegSearch was terminated without a reg being found
 or
 ♦ Reg was found and RegMove executed.

Velocity

Signal "position reached" turns into "velocity reached".

STOP

Signal "position reached" shows that the drive is at a standstill.

**No position monitoring takes place in status START (M.E5=24VDC or CW.13=1)
 Therefore reset the start signal to 0 after the START edge.**

Behavior of "Position reached" after Power On

After Power On O1 (=SW Bit 9) = "0"
 After the machine zero run (after position 0 is reached) O1 and SW.9 goes to "1"

Example:

Handshake with PLC for small positionings

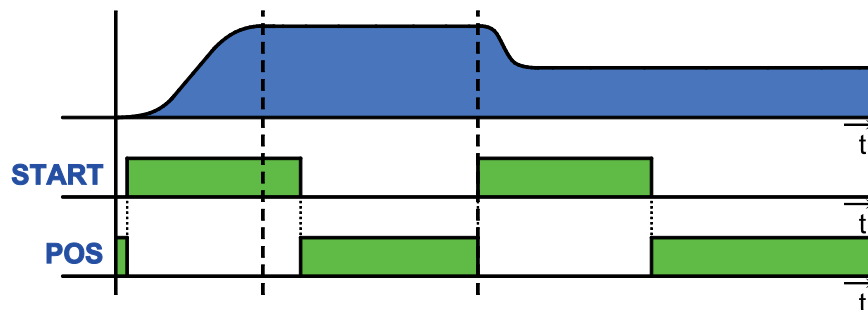

START: M.E5 or CW.13 = "1"
POS: O1: Position reached (= CW Bit 9)

Sequence:

PLC	Reaction Compax3
START of a positioning	Position reached goes to "0"
From position reached = "0" follows: START = 0	Positioning completed → Position reached = "1"
From position reached = "1" follows: Next START can take place	Position reached goes to "0"

4.1.8.3 Following error limit

The error reaction upon a following error can be set:

Possible settings for the error reaction are:

- ◆ No response
- ◆ Downramp / stop
- ◆ Downramp / stromlos schalten (standard settings)

The following error is a dynamic error.

The dynamic difference between the setpoint position and the actual position during a positioning is called the following error. Do not confuse this with the static difference which is always 0; the target position is always reached exactly.

The change of position over time can be specified exactly using the parameters jerk, acceleration and speed. The integrated Setpoint value generator calculates the course of the target position. Because of the delay in the feedback loop, the actual position does not follow the target position exactly. This difference is referred to as the following error.

Disadvantages caused by a following error

When working with a number of servo drives (for example Master controller and slave controller), following errors lead to problems due to the dynamic position differences, and a large following error can lead to positioning overshoot.

Error message

If the following error exceeds the specified following error limit, the “following error time” then expires. If the following error is even greater than the following error limit at the end of the following error time, an error is reported.

If the following error falls short of the following error limit, a new following error time is then started.

Minimizing the following error

The following error can be minimized with the help of the extended (advanced) control parameters, in particular with the feed forward parameters.

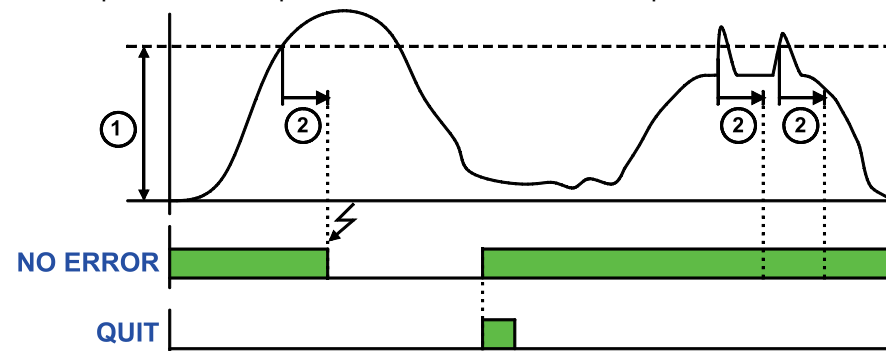

1: Following error limit

2: Following Error Time

NO ERROR: 00: no error

ACKN: I0: Quit (on positive edge)

4.1.8.4 Maximum operating speed

The speed limitation is deduced from the maximum operating speed. In order to ensure control margins, the speed is limited to a higher value.

The speed setpoint value is actively limited to 1.1 times the given value.

If the speed actual value exceeds the preset maximum speed by 21% (=“switching off limit speed”), error 0x7310 is triggered.

4.1.9. Operating mode / I/O assignment

The operating mode defines the I/O assignment of the Compax3 I/Os.

In this chapter you can read about:

I/O assignment for control via the Compax3 inputs/outputs..... 129
 I/O assignment, control word and status word with control via COM port 130

4.1.9.1 I/O assignment for control via the Compax3 inputs/outputs

If control is not made via RS232 / RS485, an M - option (M10 or M12) will be required. The assignment of the inputs and outputs is fixed.

Assignment of the intra-device inputs and outputs

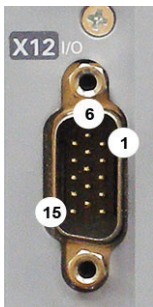

Pin X12	Input / Output	High density/Sub D	
1	O	+24 V DC output (max. 400mA)	Only for "fixed assignment" Functions are available, if "Fixed assignment" was selected for the I/O assignment in the configuration wizard
2	O0	No error	
3	O1	Position / speed / gear synchronization attained (max. 100 mA)	
4	O2	Power stage without current (max. 100mA)	
5	O3	Axis energized with a setpoint of 0 (max. 100 mA)	
6	I0="1":	Quit (positive edge) / activate the axis	
	I0="0"	Axis disable with delay	
7	I1	no Stop	
8	I2	JOG +	
9	I3	JOG -	
10	I4	Reg input	
11	I	24V input for the digital outputs Pins 2 to 5	
12	I5	Limit switch 1	
13	I6	Limit switch 2	
14	I7	Machine zero initiator	
15	O	GND24V	

All inputs and outputs have 24V level.

Maximum capacitive loading of the outputs: 30nF (max. 2 Compax3 inputs can be connected)

Input-/Output extension (see on page 129)

Optimization window display

The display of the digital inputs in the optimization window of the C3 ServoManager does not correspond to the physical status (24Volt=on, 0Volt=off) but to the logic status: if the function of an input or output is inverted (e.g. limit switch, negatively switching), the corresponding display (LED symbol in the optimization window) is OFF with 24Volts at the input and ON with 0 Volts at the input.

Assignment of the optional inputs and outputs (M option)



Pin X22/	Input/output	High density/Sub D
1	n.c.	factory use
2	M.I0	Address 0
3	M.I1	Address 1
4	M.I2	Address 2
5	M.I3	Address 3
6	M.I4	Address 4
7	M.I5	Start (edge triggered)
8	M.I6	no Stop (2nd Stop input)
9	M.I7	Open motor holding brake
10	M.O8	Machine zero (home) Position known
11	I	24 VDC power supply
12	M.O9	programmable status bit 0 (PSB0)
13	M.O10	programmable status bit 1 (PSB1)
14	M.O11	programmable status bit 2 (PSB2)
15	E	GND24V

* free assignment at operation via RS232 / RS485 as well as configurable in groups of 4 as inputs or outputs (C3 ServoManager).

- ◆ All inputs and outputs have 24V level.
 - ◆ The input/output designation M.I0 ... helps to make the distinction between the standard I/Os on X12 and the inputs/outputs of the M options.
 - ◆ Maximum load on an output: 100mA
 - ◆ Maximum capacitive load: 50nF (max. 4 Compax3 inputs)
- Caution! The 24VDC power supply (X22/11) must be supplied from an external source and must be protected by a 1.2A delayed fuse!

Reaction times:

Example:

I0="1" (energize Motor) => O3="1" (Motor energized) max. 4ms
 M.I5="1" (START edge) => O3="0" max. 4ms

4.1.9.2 I/O assignment, control word and status word with control via COM port

In this chapter you can read about:

I/O Assignment 131
 Control Word 132
 Status word 1 & 2 133

I/O Assignment

- ◆ For intra-device inputs I0 .. I3 as well as the outputs O0 ... O3 you can choose between fixed or free assignment (see below).
- ◆ Control via RS232 / RS485 does not require an M option (M10 / M12).
- ◆ If an M option is available, 12 inputs/outputs (ports) are freely assignable. These can be configured as inputs or outputs by groups of four and be activated or read via Object 121.2 and Object 133.3.
- ◆ The signal inputs I4 ... I7 are fixedly assigned
If the respective functions are not needed, these inputs can also be used for control.
I5 and I6 can, for example, be used as free inputs if the limit switch function is deactivated.

Assignment of the intra-device inputs and outputs

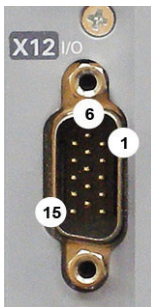

Pin X12	Input / Output	High density/Sub D	
1	O	+24 V DC output (max. 400mA)	
2	O0	No error	Only for "fixed assignment" Functions are available, if "Fixed assignment" was selected for the I/O assignment in the configuration wizard
3	O1	Position / speed / gear synchronization attained (max. 100 mA)	
4	O2	Power stage without current (max. 100mA)	
5	O3	Axis energized with a setpoint of 0 (max. 100 mA)	
6	I0="1":	Quit (positive edge) / activate the axis	
	I0="0"	Axis disable with delay	
7	I1	no Stop	
8	I2	JOG +	
9	I3	JOG -	
10	I4	Reg input	
11	I	24V input for the digital outputs Pins 2 to 5	
12	I5	Limit switch 1	
13	I6	Limit switch 2	
14	I7	Machine zero initiator	
15	O	GND24V	

All inputs and outputs have 24V level.

Maximum capacitive loading of the outputs: 30nF (max. 2 Compax3 inputs can be connected)

Input-/Output extension (see on page 129)

Optimization window display

The display of the digital inputs in the optimization window of the C3 ServoManager does not correspond to the physical status (24Volt=on, 0Volt=off) but to the logic status: if the function of an input or output is inverted (e.g. limit switch, negatively switching), the corresponding display (LED symbol in the optimization window) is OFF with 24Volts at the input and ON with 0 Volts at the input.

For intra-device inputs I0 .. I3 as well as the outputs O0 ... O3 you can choose between fixed or free assignment.

With fixed assignment of the intra-device inputs I0 ... I3, the respective functions can either be triggered via the inputs or via RS232 / RS485

It applies:

- ◆ The motor is only energized if I0 = "1" AND control word Bit 0 = "1"
- ◆ Stop is active if, I1 = "0" OR Control word Bit 1 = "0"
- ◆ Manual+ and Manual- inputs and control word are OR - linked.

Control Word**Structure of the control word (object 1100.3)**

Bit	Function	Corresponds to *
Bit0	Quit (edge) / energize axis	I0: X12/6
Bit1	No Stop	I1: X12/7
Bit2	JOG +	I2: X12/8
Bit3	JOG -	I3: X12/9
Bit4	O0 X12/2	(only if O0...O3 is defined as freely assignable)
Bit5	O1 X12/3	
Bit6	O2 X12/4	
Bit7	O3 X12/5	
Bit8	Address 0	
Bit9	Address 1	
Bit10	Address 2	
Bit11	Address 3	
Bit12	Address 4	
Bit13	Start (edge) The address of the current motion set is read in new.	
Bit14	No Stop (2nd Stop)	
Bit15	Open brake	

* does only apply if the respective inputs are assigned fixedly.
Bit0 = least significant Bit

Status word 1 & 2**Structure of the state word 1 (object 1000.3)**

Bit	Description	Corresponds to *
Bit0	I0	X12/6
Bit1	I1	X12/7
Bit2	I2	X12/8
Bit3	I3	X12/9
Bit4	I4	X12/10
Bit5	I5	X12/11
Bit6	I6	X12/12
Bit7	I7	X12/13
Bit8	No error	X12/2
Bit9	Position reached	X12/3
Bit10	Axis powerless	X12/4
Bit11	Axis stationary with current at setpoint value zero	X12/5
Bit12	Machine zero (home) Position known	
Bit13	Programmable status bit 0 (PSB0)	
Bit14	Programmable status bit 1 (PSB1)	
Bit15	Programmable status bit 2 (PSB2) <C3F_2_axes_alignment>	

* Does apply for Bit 8 ... 11 only if the respective outputs (O0 ... O3) are assigned fixedly.

Bit0 = least significant Bit

Structure of the state word 2 (object 1000.4)

Bit	Description	
Bit0 ... 14	factory use	
Bit15	Reg detected	

Bit0 = least significant Bit

4.1.10. Encoder simulation

You can make use of a permanently integrated encoder simulation feature to make the actual position value available to additional servo drives or other automation components.

Position of zero pulse:

Before R09-40 the zero pulse is coupled fixedly to the motor zero point (zero crossing of the feedback position without absolute reference). This resulted in a unequivocal and repeatable zero pulse position at all feedback devices (Resolver, SinCos(R), EnDat, analogue Hallsensors, at C3Fluid: SSI-feedback system, analogue feedback).

With R09-40 the zero pulse is adjustable in the range of -180...180 (object 0620.6) - furthermore teaching of the zero pulse for the actual motor position is possible by writing 0620.7 with -1 or by entering ":TEACH_ENC_SIM_ZERO" in the entry field of the optimization window.

Zero pulse with multiple pole feedback sensor:

With these feedback systems the simulation does not refer to the mechanical motor position but to the feedback position, this means the correct quantity of A/B pulses is put out to a motor revolution respectively to a motor pitch, however the zero pulse output multiply occurs within one motor revolution respectively within one motor pitch. (Quantity=figure pair of feedback pole=feedback pole figure/2).

At linear feedback systems 50mm correspond to a virtual motor revolution.

Caution!

- ◆ The encoder simulation (A/B) is not possible at the same time as the encoder input, der SSI-Schnittstelle resp. the step/direction input.
The same interface is used here.
- ◆ A direction reversal configured in the C3 ServoManager does not affect the encoder simulation.
The direction of rotation of the encoder simulation can, however, be changed via the feedback direction in the MotorManager.

Simulated Encoder Output Resolution

Unit: Increments per revolution / pitch	Range: 4 - 16384	Standard value: 1024
Any resolution can be set Limit frequency: 620kHz (track A or B) i.e. , with:		
Increments per revolution	max. Velocity	
1024	36000 rpm	
4096	9000 rpm	
16384	2250 rpm	

4.1.10.1 Encoder bypass with Feedback module F12 (for direct drives)

If the feedback module F12 is used, the encoder signals can be placed directly (Bypass) to the encoder interface (X11: same assignment as encoder simulation) for further use. Sine/Cosine signals are directly converted into encoder signals, however no additional zero pulse is generated; an available zero pulse will be transmitted.

The advantage is, that the limit frequency** is 5MHz instead of 620kHz (track A or B).

The direction of rotation is only defined via the encoder wiring; a direction inversion configured in the C3 ServoManager does not have any consequence.

** Limit frequency = 1MHz for Compax3M (higher bandwidths on request)

4.1.11. Absolute- /continuous mode

Operating mode: Absolute mode or continuous mode

Absolute mode A fixed measuring system is associated with the travel range: A fixed defined zero point exists. All positions are referred to this zero point.

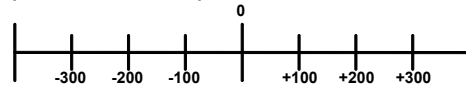

Continuous mode The actual position is set to 0 before each positioning. Thus the travel range has no fixed zero point. All positionings are relative - in relation to the actual position.

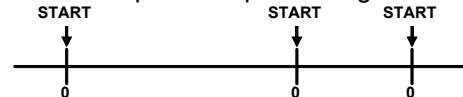

4.1.12. Position mode in reset operation

[In this chapter you can read about:](#)

In reset operation (activated by the configured reset distance), additional positioning functions are possible for absolute positionings (can be set under configuration in the "Positioning options / positioning profiles" window only in bus mode "Positioning" or "Profile selection"):

All directions	Standard positioning mode
Positive direction	Positioning only in positive direction
Shortest path	Positioning on the shortest path
Negative direction	Positioning only in negative direction
Actual direction	Positioning by keeping the actual direction of travel

Dynamic positioning

In dynamic positioning, a decision concerning the positioning travel is not taken on the basis of the actual position, but on the basis of the braking position resulting from the motion parameters.

Please observe:

◆ **In the event of positioning specifications below zero and higher than or equal to the reset distance, this function is deactivated.**

The positioning target must for instance be in the range between 0..359.999999° for a reset distance of 360°.

◆ The positioning functions are neither effective in test movements nor in an automatic positioning after homing travel (if this was not deactivated in the configuration).

◆ In the event of "shortest path", the motion is not defined for a positioning by a travel of half the reset distance.

In the help file you can find examples for the functioning of the individual positioning modes.

4.1.13. Defining the STOP function

The function "no STOP" is configurable.

No Stop: Input I1 and M.I6 resp. CW.1 and CW.14

STOP with termination

STOP and terminate the current positioning

A new START does not continue the positioning at the interruption point.

The motion set address is read in new and the motion set is executed completely.

Example: before the new START the motion set address "Pos x+1" was created.

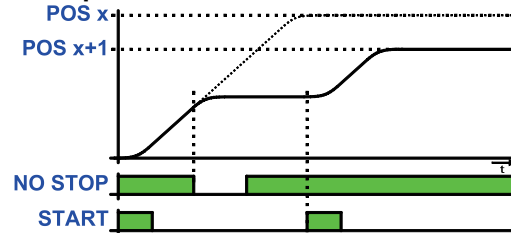

NO STOP: no STOP
START: START signal (on edge)

STOP without termination

STOP and interruption of the current positioning procedure.

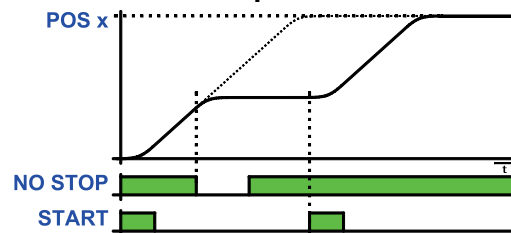

NO STOP: no STOP
START: START signal (on edge)

A new START resumes the positioning process at the position where it was interrupted.

4.1.14. Reg-related positioning / defining ignore zone

These settings are only required in connection with the function “**reg-related positioning** (see on page 141)“.

Within the reg window a reg signal will be ignored.

The reg window is defined by

- ◆ Beginning of the ignore zone and
- ◆ End of the ignore zone

Beginning and end of the ignore zone are absolute values and therefore are also valid with negative position values.

This reg window is valid for all reg position sets.

Allow higher deceleration for RegMove

If the deceleration set in the RegMove motion set is too low, the target position is not reached. **Compax3 reports error** (see on page 144).

By allowing for a higher deceleration, Compax3 sets the jerk and the deceleration so that the target is reached without direction reversal.

Function:

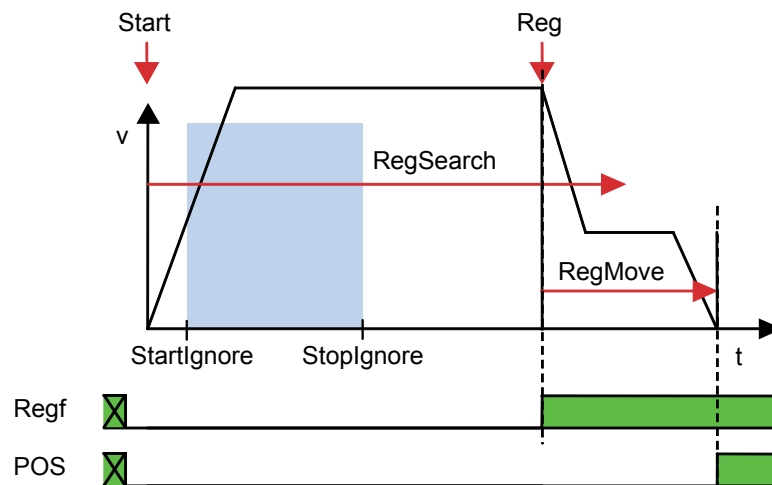

Start	Start signal for reg positioning
RegSearch:	Positioning for reg search
RegMove:	Positioning according to reg
StartIgnore:	Reg window: Beginning of the ignore zone
StopIgnore:	Reg window: End of the ignore zone
Reg:	Reg signal (I4 on X12/10)
Regf	Signal: Reg detected (Status word 2 Bit15 (Signal via PSBs with I/O control))
POS:	Signal: Position reached (Output O1: X12/3 or status word 1 Bit 9)

4.1.15. Write into set table

The motion sets are stored in a set table.

The table rows define always one motion set, in the columns the respective motion parameters of a motion set are stored.

	Motion parameters				
Machine reference run					
Set 1					
Set 2					
...					
Set 31					

Exact description (see on page 277).

31 motion sets are possible.

The motion set to be executed is selected via:

◆ Compax3 inputs (with control via I/Os)

or

◆ via the control word (with control via RS232 / RS285).

For the motion sets different motion functions with different motion parameters are available:

- ◆ **Empty:** empty motion set
- ◆ **MoveAbs (see on page 140):** absolute positioning
- ◆ **MoveRel (see on page 140):** relative Positioning
- ◆ **Gearing (see on page 145):** electronic gearbox
- ◆ **RegSearch (see on page 141):** Registration mark-related positioning (uses 2 motion sets: RegSearch and RegMove)
- ◆ **Velocity (see on page 147):** Velocity control
- ◆ **Stop:** Stop movement

For each motion set you can define programmable status bits (PSBs), which will then be put out after the termination of the motion set.

Homing run A start signal at address = 0 (motion set 0) triggers a machine zero run.

4.1.15.1 Dynamic positioning

You can change over to a new motion set during a positioning process. All motion parameters of the new data record become valid

Hint The new motion set address must not equal 0.

Example: MoveAbs (Target position POS1) is interrupted by a new MoveAbs with target position (POS 5)

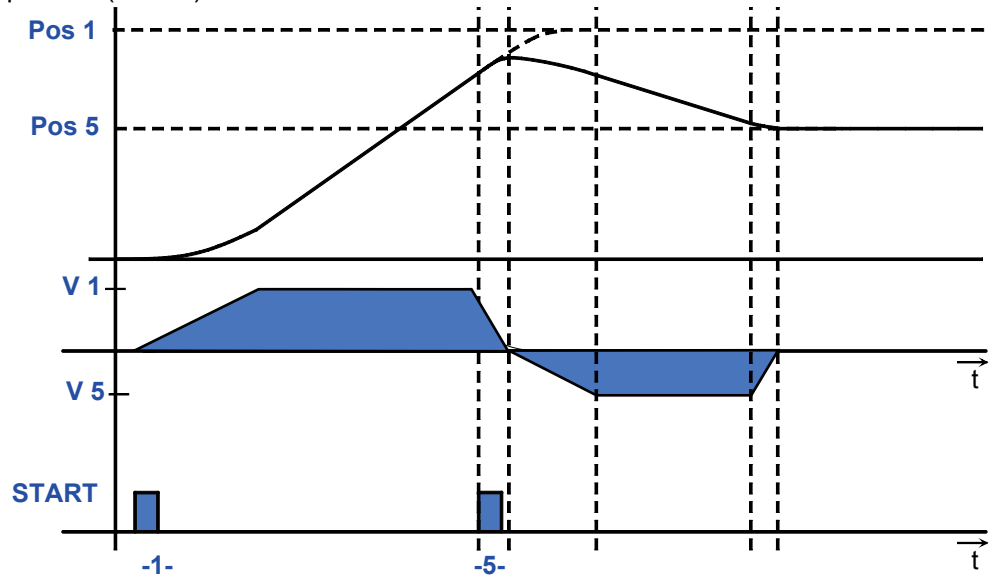

The following dynamic transitions are supported:

Motion function in progress	Possible dynamic change to the motion function:
MoveAbs, MoveRel, RegSearch, RegMove, Velocity	MoveAbs, MoveRel, Velocity, RegSearch, Gearing
Gearing	MoveAbs, MoveRel, RegSearch, Gearing (other gearing factor)
Stop	-

If the homing mode is active, there will always be a homing run with the first start after each configuration download (with the aid of the C3 ServoManager) **Homing run** (see on page 137).

4.1.15.2 Programmable status bits (PSBs)

The successful execution of a motion set can be queried via the PSBs.

PSBs:

- ◆ with control via I/Os:
 - 3 outputs of the I/O option (M10 or M12) M.O9, M.O10, M.O11
- or
- ◆ with control via RS232 / RS485:
 - status word Bit 13, Bit 14, Bit 15

Definition of the pattern:

The settings for the PSBs are made in the respective motion set

You can set 3 assignments for the respective bits:

- X: no change Output / Bit is not influenced
- 0: Inactive Output / Bit is set to 0
- 1: Active Output / Bit is set to 1 resp. 24VDC

Storage of the **PSBs** (see on page 277).

Programmable status bits (PSBs)

The successful execution of a motion set can be queried via the PSBs.

PSBs: Bit 12, 13 and 14 of status word 2.

4.1.15.3 Set selection

Set number:

Address of the positioning data record.

The address results from the binary value of the inputs:

I/O control	RS232/RS485 - Control Control word	Values
M.I0	Bit 8	$2^0 = 1$
M.I1	Bit 9	$2^1 = 2$
M.I2	Bit 10	$2^2 = 4$
M.I3	Bit 11	$2^3 = 8$
M.I4	Bit 12	$2^4 = 16$

4.1.15.4 MoveAbs and MoveRel

A motion set defines a complete motion with all settable parameters.

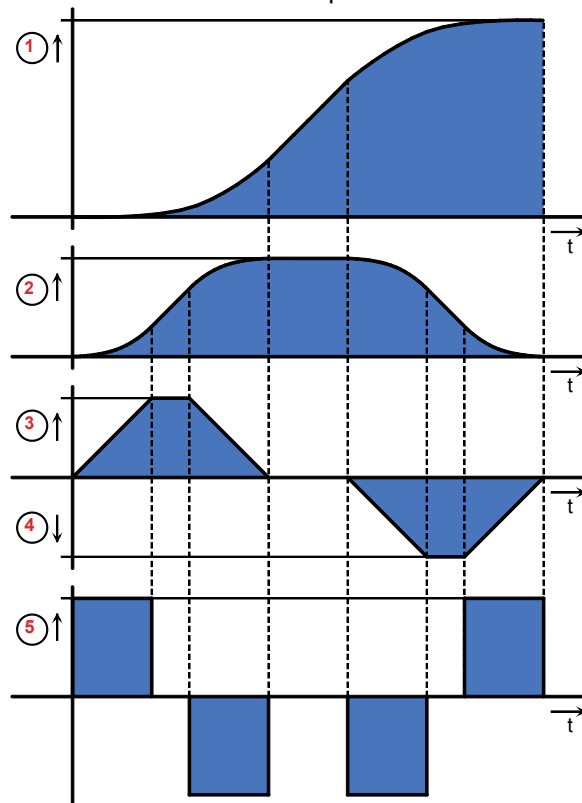

- 1: Target position
- 2: Travel speed
- 3: Maximum Acceleration
- 4: Maximum deceleration
- 5: Maximum **Jerk** (see on page 124)

Motion functions

MoveAbs: Absolute positioning.
MoveRel: Relative positioning

Target position / distance

Target position of the chosen unit of measure.
 Distance with MoveRel

Speed

Speed in length unit/s

Acceleration

Acceleration in unit/s²

Deceleration

Deceleration in unit/s²

Jerk

Jerk in unit/s³
 You can optimize the motion profile data with the "**ProfilViewer**" (see on page 266) software tool!

4.1.15.5 Reg-related positioning (RegSearch, RegMove)

For registration mark-related positioning, 2 motions are defined.

- RegSearch** Search movements: Relative Positioning in order to search for an external signal - of a reg
 This may, for example, be a reg on a product.
- RegMove** The external signal interrupts the search movement and the second movement by the predefined offset follows without transition. The drive comes to a standstill at the position of the mark signal + the configured offset.

Accuracy of the reg detection : <1μs

Please note:

The reg restriction window is the same for all reg motion sets!

Example 1: Reg comes after the reg restriction window

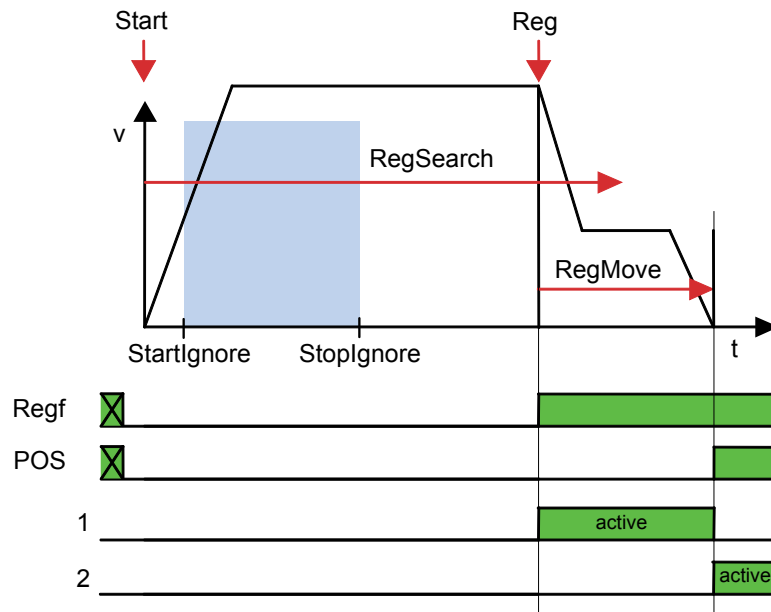

- Start** Start signal for reg positioning (M.E5 an X22/13 oder STW.13)
- RegSearch:** Positioning for reg search
- RegMove:** Positioning according to reg
- Startignore:** **Reg ignore window:** (see on page 137) Beginning of the ignore zone
- Stopignore:** Reg ignore window: End of the ignore zone
- Reg:** Reg signal (I4 on X12/10)
- Regf:** Signal: Reg detected (Status word 2 Bit15 (Signal via PSBs with I/O control))
- POS:** Signal: Position reached (Output O1: X12/3 or status word 1 Bit 9)
- 1** Programmable status bits of RegSearch (only for positioning with set selection)
- 2** Programmable status bits of RegMove (only for positioning with set selection)

Example 2: Reg within the reg restriction window

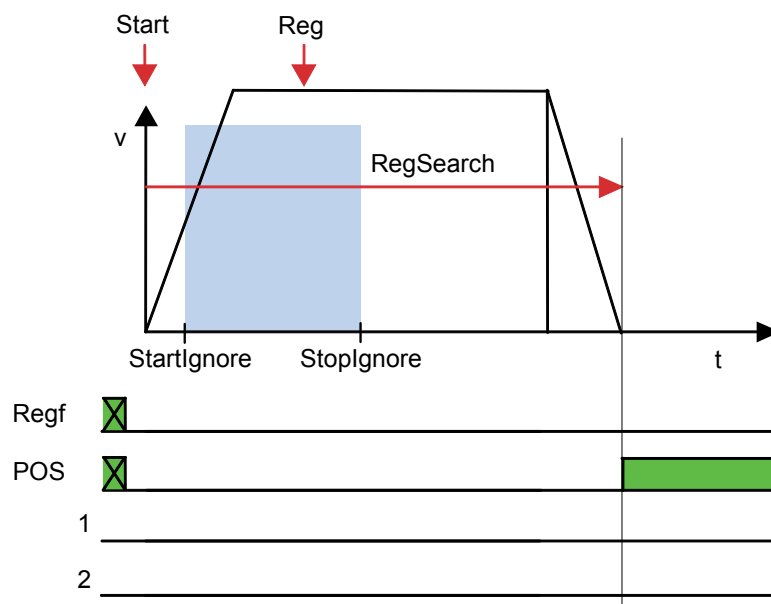

Start Start signal for reg positioning (M.E5 an X22/13 oder STW.13)
RegSearch: Positioning for reg search
RegMove: Positioning according to reg
StartIgnore: **Reg ignore window:** (see on page 137) Beginning of the ignore zone
StopIgnore: Reg ignore window: End of the ignore zone
Reg: Reg signal (I4 on X12/10)
Regf: Signal: Reg detected
 (Status word 2 Bit15 (Signal via PSBs with I/O control))
POS: Signal: Position reached
 (Output O1: X12/3 or status word 1 Bit 9)
 1 Programmable status bits of RegSearch (only for positioning with set selection)
 2 Programmable status bits of RegMove (only for positioning with set selection)
 The reg is ignored; the drive moves to the target position from the RegSearch motion set.

Example 3: Reg is missing or comes after termination of the RegSearch motion set

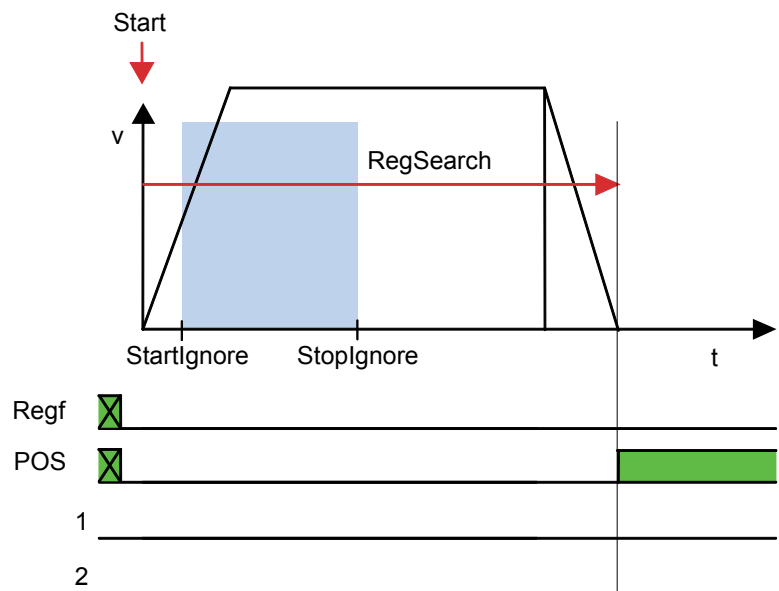

Start Start signal for reg positioning (M.E5 an X22/13 oder STW.13)
RegSearch: Positioning for reg search
RegMove: Positioning according to reg
StartIgnore: **Reg ignore window:** (see on page 137) Beginning of the ignore zone
StopIgnore: Reg ignore window: End of the ignore zone
Reg: Reg signal (I4 on X12/10)
Regf: Signal: Reg detected
 (Status word 2 Bit15 (Signal via PSBs with I/O control))
POS: Signal: Position reached
 (Output O1: X12/3 or status word 1 Bit 9)
 1 Programmable status bits of RegSearch (only for positioning with set selection)
 2 Programmable status bits of RegMove (only for positioning with set selection)

The drive moves to the target position from the RegSearch motion set

Example 4: Reg comes before the reg restriction window

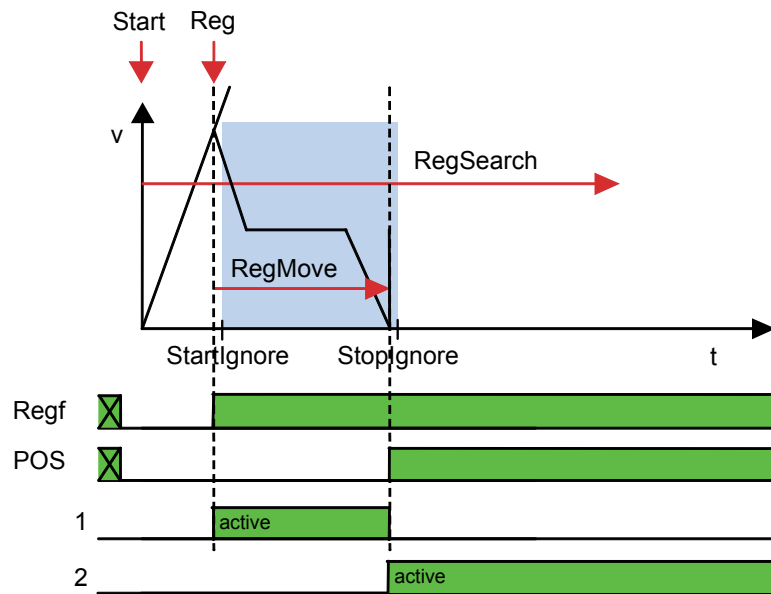

- Start** Start signal for reg positioning (M.E5 an X22/13 oder STW.13)
- RegSearch:** Positioning for reg search
- RegMove:** Positioning according to reg
- Startignore:** **Reg ignore window:** (see on page 137) Beginning of the ignore zone
- Stopignore:** Reg ignore window: End of the ignore zone
- Reg:** Reg signal (I4 on X12/10)
- Regf:** Signal: Reg detected (Status word 2 Bit15 (Signal via PSBs with I/O control))
- POS:** Signal: Position reached (Output O1: X12/3 or status word 1 Bit 9)
- 1** Programmable status bits of RegSearch (only for positioning with set selection)
- 2** Programmable status bits of RegMove (only for positioning with set selection)

As from the mark, the drive moves on relatively by the offset defined in RegMove and then stops at that position (same behavior as in example 1).

Example 5: The registration mark comes after the reg restriction window, registration mark can, however, not be reached without direction reversal

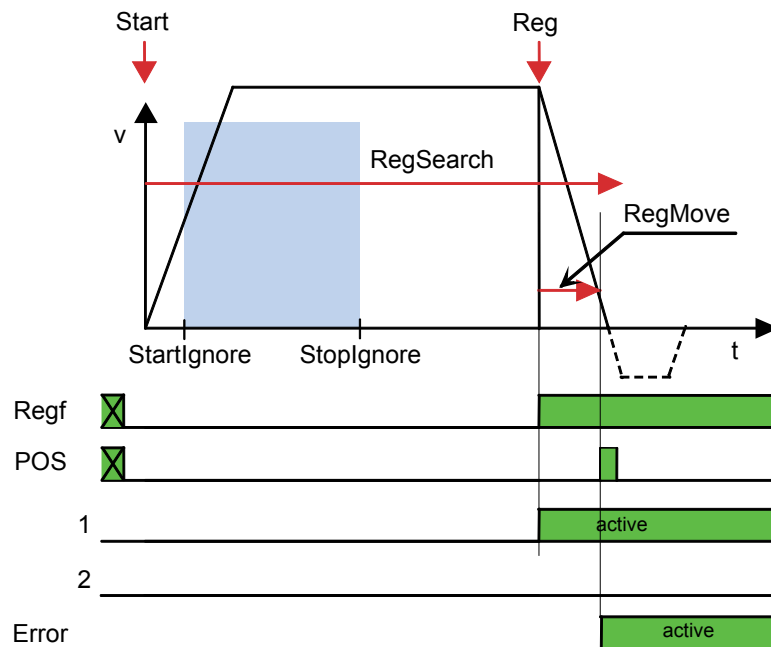

Start	Start signal for reg positioning (M.E5 an X22/13 oder STW.13)
RegSearch:	Positioning for reg search
RegMove:	Positioning according to reg
StartIgnore:	Reg ignore window: (see on page 137) Beginning of the ignore zone
StopIgnore:	Reg ignore window: End of the ignore zone
Reg:	Reg signal (I4 on X12/10)
Regf:	Signal: Reg detected (Status word 2 Bit15 (Signal via PSBs with I/O control))
POS:	Signal: Position reached (Output O1: X12/3 or status word 1 Bit 9)
1	Programmable status bits of RegSearch (only for positioning with set selection)
2	Programmable status bits of RegMove (only for positioning with set selection)
Error	Output A0: X12/2 or status word 1 Bit 8

Position reached can be activated for a short period, if the position window was not linked to the command value.

With "**Allow higher deceleration for RegMove** (see on page 137)", Compax3 sets the required deceleration.

4.1.15.6 Electronic gearbox (Gearing)

The motion function "Gearing" (electronic gearbox) moves Compax3 synchronously with a leading axis.

A 1:1 synchronism or any transmission ratio can be selected via the gear factor.

A negative sign - which means reversal of direction - is permitted.

Function: Electronic gearbox (Gearing)

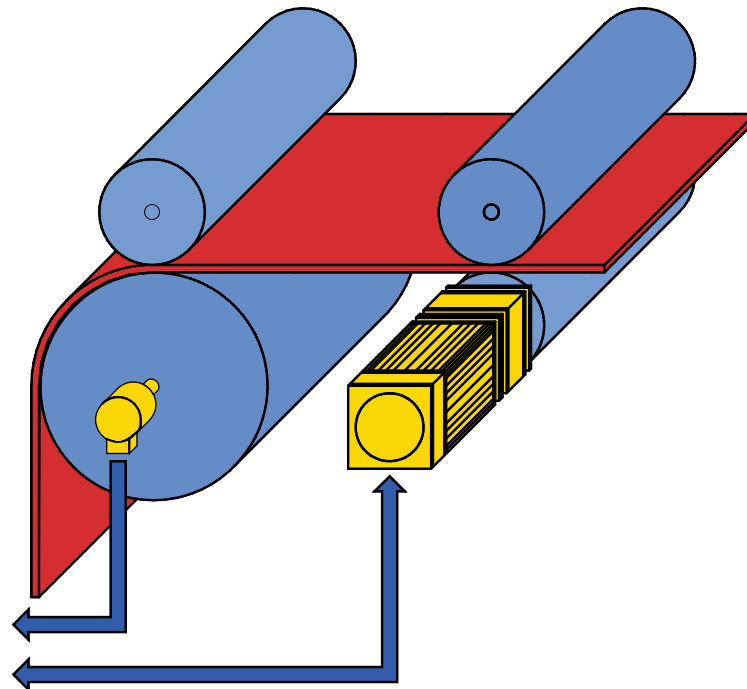

The position of a master axis can be detected via:

- ◆ +/-10V analog input
- ◆ Step / direction input (X11/6, 7, 8, 12)
- ◆ the encoder input (X11/6, 7, 8, 12) or
- ◆ HEDA, if Compax3 is used as master drive.

The master signal detection is configured under synchronization.

Settings of the “Gearing” motion function

Gearing numerator / Gearing denominator:

Transmission ratio slave / master

The transmission ratio (gear factor) can be entered in “Gearing numerator” (at “Gearing denominator” = 1).

You will obtain an exact image of a non-integral transmission ratio by entering the value integrally as a fraction with numerator (integral) and denominator (integral). Long-term drifts can only be avoided by using integral values.

That is:

$$\frac{\text{Slave}}{\text{Master}} = \frac{\text{Gearing numerator}}{\text{Gearing denominator}}$$

Acceleration

Here you can define the acceleration for the drive to reach the desired synchronism.

Dynamic change of the gear factor

You can switch dynamically between 2 gearing motion sets with different gear factors.

The set acceleration counts as deceleration if the gear factor is reduced.

Dynamic switching between the gearing motion function and positioning functions (MoveAbs, MoveRel, RegSearch) is possible.

Synchronicity:

With the "Gear reached" signal (Output O1: X12/3 or status word 1 Bit 9), the reaching of the synchronicity is displayed.

The signal “Gear reached” is reset if the synchronicity is exited.

The programmable status bits (PSBs) are activated via the signal “Gear reached”.

Limiting effects

If the synchronicity is lost temporarily due to limitations, the resulting position difference is made up afterwards.

Note: Jerk is not limited.

4.1.15.7 Speed specification (Velocity)

This motion function is defined by velocity and acceleration.

An active motion set is interrupted by:

- ◆ Stop or
- ◆ Start of a different set.

As soon as the setpoint speed is reached, "speed reached" (Output O1: X12/3 or status word 1 Bit 9) as well as the defined status bits (PSBs) are activated.

Note: Position control is active, i.e. the following error caused by limitations will be made up.
Jerk is not limited.

4.1.15.8 Stop command (Stop)

The Stop set interrupts the current motion set (Stop with interruption).

This motion function is defined by the deceleration and the jerk of the drive when coming to a standstill.

As soon as the drive is at standstill "position reached" (Output O1: X12/3 or status word 1 Bit 9) as well as the defined status bits (PSBs) are activated.

Note: The stop command (as motion function) is not effective during the machine zero run.

4.1.16. Error response

Under "configuring: Error reaction" you can change the error reaction for individual **errors** (see on page 301) (the error no. which can be influenced is displayed).

Possible settings for the error reaction are:

- ◆ No response
- ◆ Downramp / stop
- ◆ Downramp / stromlos schalten (standard settings)

Note on Compax3H:

The error reaction upon the "low voltage DC" error (0x3222) is fixed to "downramp/deenergize" for Compax3H.

4.1.17. Configuration name / comments

Here you can name the current configuration as well as write a comment.

Then you can download the configuration settings or, in T30 or T40 devices, perform a complete Download (with IEC program and curve).

	<p>Caution! Deactivate the drive before downloading the configuration software! Please note! Incorrect configuration settings entail danger when activating the drive. Therefore take special safety precautions to protect the travel range of the system.</p>
---	---

	<p>Mechanical limit values! Observe the limit values of the mechanical components! Ignoring the limit values can lead to destruction of the mechanical components.</p>
---	---

4.2 Configuring the signal Source

In this chapter you can read about:

Signal source of the load feedback system 148
 Select signal source for Gearing 148

4.2.1. Signal source of the load feedback system

Configuration of the **load control** (see on page 153) (Dual Loop Option)

4.2.2. Select signal source for Gearing

In this chapter you can read about:

Signal source HEDA 149
 Encoder A/B 5V, step/direction or SSI feedback as signal source 150
 +/-10V analog speed setpoint value as signal source 151

Here the signal source is configured for the motion function “Gearing” (electronic gearbox).

Available are:

Gearing input signal source

- ◆ The HEDA real-time bus (M10 or M11 option) directly from a Compax3 master axis
- ◆ an encoder signal A/B 5V
- ◆ a step/direction signal 5V
- ◆ a velocity as analog value +/-10V
- ◆ SSI feedback (X11)

HEDA operating mode: HEDA-Master

Under signal source gearing "not configured" must be set!

If an existing HEDA option (M10 or M11) is not used as signal source, you can transmit the following signals for a slave axis via HEDA (HEDA-Master) :

- ◆ Setpoint position value (Object 2000.1)
 - ◆ Actual position (Object 2200.2)
 - ◆ Setpoint position value from virtual Master (object 2000.2)
 - ◆ External position value (Object 2020.1)
- Signal read into the master via <Analog channel_C3_C3F>, Encoder input or step/direction input.

Principle:

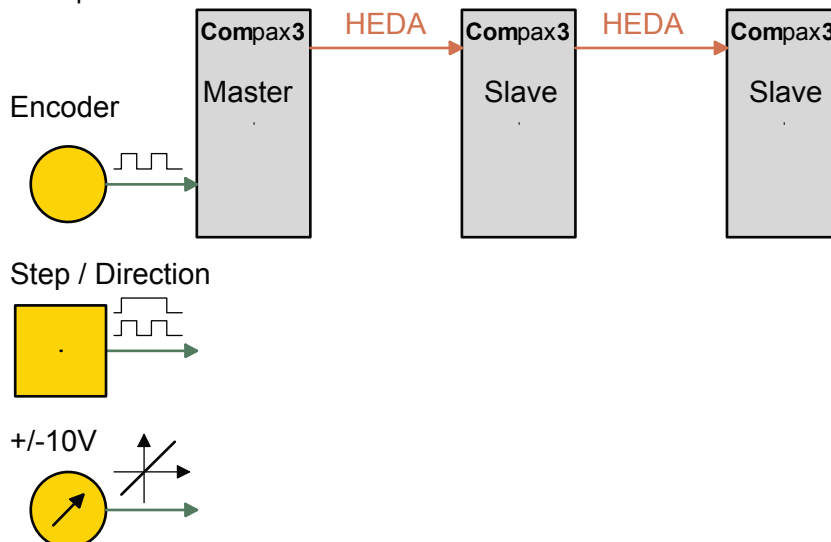



Attention in the case of a configuration download with master-slave coupling (electronic gearbox, cam)

Switch Compax3 to currentless before starting the configuration download:
Master and Slave axis

4.2.2.1 Signal source HEDA

Signal source is a Compax3 master axis in which the HEDA operating mode "HEDA master" is set.

Please enter besides the desired error reaction an individual HEDA axis address in the range from 1 ...32.

Here the dimensional reference to the master position is established.

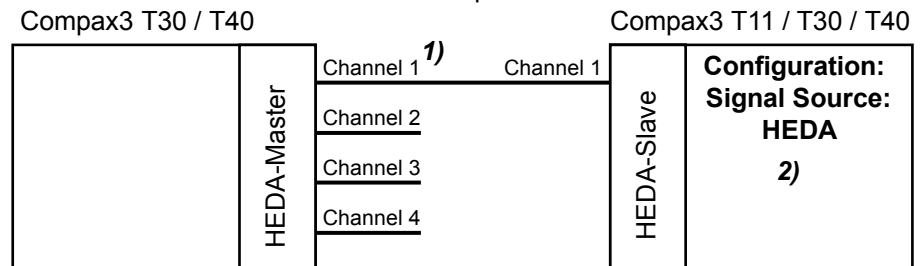

The position value are transferred via channel 1.

1) Select the position value to be transferred on the Compax3 HEDA-Master (Target position value, actual position value, external position value or position value of the virtual Master)).

2) By specifying the source under "Configuration: Configuration of the signal source:HEDA", most of the reference values are pre-set.

- ◆ Standard source
 - Position value of the rotative drives
 - Travel path per motor revolution master axis numerator
 - With denominator = 1 the value can be entered directly.
 - Long-term drift can be avoided by entering non-integral values integrally as a fraction with numerator and denominator.
- ◆ Position value of virtual master of Compax3 T40
- ◆ Position value of linear motor (mm)
 - Please enter pitch length in mm
- ◆ Position value of linear motor (inch)
 - Please enter pitch length in inch
- ◆ Position value of hydraulic cylinder - linear feedback (metric) of Compax3F
- ◆ Position value of hydraulic cylinder - linear feedback (imperial) of Compax3F
- ◆ Position value of hydraulic cylinder - rotary feedback of Compax3F

1) Select the position value to be transferred on the Compax3 HEDA-Master (Target position value, actual position value, external position value or position value of the virtual Master)).

If required the direction of rotation of the master axis read in can be changed.

4.2.2.2 Encoder A/B 5V, step/direction or SSI feedback as signal source

- Caution!**
- ◆ The encoder simulation (A/B) is not possible at the same time as the encoder input, der SSI-Schnittstelle resp. the step/direction input.
The same interface is used here.
 - ◆ A direction reversal configured in the C3 ServoManager does not affect the encoder simulation.
The direction of rotation of the encoder simulation can, however, be changed via the feedback direction in the MotorManager.
- The dimensional reference to the master is established via the following settings:
- ◆ Travel path per motor revolution (or pitch for linear motors) master axis numerator
With denominator = 1 the value can be entered directly.
Long-term drift can be avoided by entering non-integral values integrally as a fraction with numerator and denominator.
 - ◆ Travel per motor revolution (or pitch of linear motors) master axis denominator
 - ◆ Increments per revolution of the master axis
- If required the direction of rotation of the master axis read in can be changed.

Example: Electronic gearbox with position detection via encoder

Reference to master axis The reference to the master axis is established via the increments per revolution and the travel path per revolution of the master axis (corresponds to the circumference of the measuring wheel).
That is:

$$\text{MasterPos} = \frac{\text{Master_I}}{I_M} * \frac{\text{Travel Distance per Master Axis revolution}}{\text{Travel Distance per Master Axis revolution} - \text{Denominator}} \quad (1)$$

MasterPos: Master Position

Master_I: master increments read in

I_M: Increments per revolution of the master axis

External signal source Encoder with 1024 increments per master revolution and a circumference of the measuring wheel of 40mm.

Settings: Travel path per revolution of the master axis numerator = 40
Travel path per revolution of the master axis denominator = 1
Increments per revolution of the master axis = 1024

Configuration wizard: Reference system of Slave axis: Unit of measure [mm]
Travel path per revolution numerator = 1
Travel path per revolution denominator = 1

Gearing: Gearing numerator = 2
Gearing denominator = 1

This results in the following interrelations:

If the measuring wheel moves by 40mm (1 master revolution), the slave axis will move by 80mm.

$$\text{Slave unit} = \text{MasterPos} * \frac{\text{Gearing numerator}}{\text{Gearing denominator}} \quad (2)$$

(1) set into (2) and with numerical values results with 1024 increments read in (=1 Master revolution):

$$\text{Slave unit} = 1024 * \frac{1}{1024} * \frac{40\text{mm}}{1} * \frac{2}{1} = 80\text{mm}$$

Master - Position = +40mm => Slave - Position = +80mm

Structure:

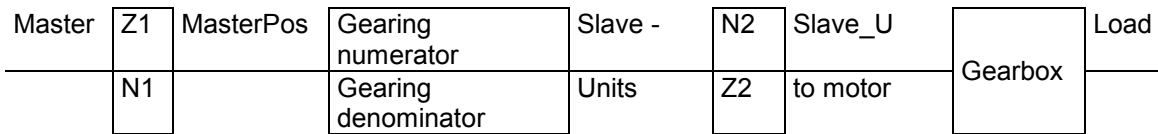

Detailed structure image (see on page 224, see on page 225) with:

$$MD = \frac{Z1}{N1} * \frac{\text{Travel Distance per Master Axis revolution}}{\text{Travel Distance per Master Axis revolution - Denominator}}$$

Entry in the "configuration of the signal source" wizard

$$SD = \frac{Z2}{N2} * \frac{\text{Travel path per revolution slave axis numerator}}{\text{Travel path per revolution slave axis denominator}}$$

Entry in the "configuration of the signal source" wizard

MD: Feed of the master axis

SD: Feed of the slave axis

4.2.2.3 +/-10V analog speed setpoint value as signal source

Via Analogkanal 0 (X11/9 und X11/11) the speed of the master is read in.

From this value a position is internally derived, from which then the motion of the drive is derived with reference to the transmission ratio.

Without limitation effect applies:

Velocity of the master * (Gearing numerator / gearing denominator) = velocity of the slave

Signal processing of the analog input 0

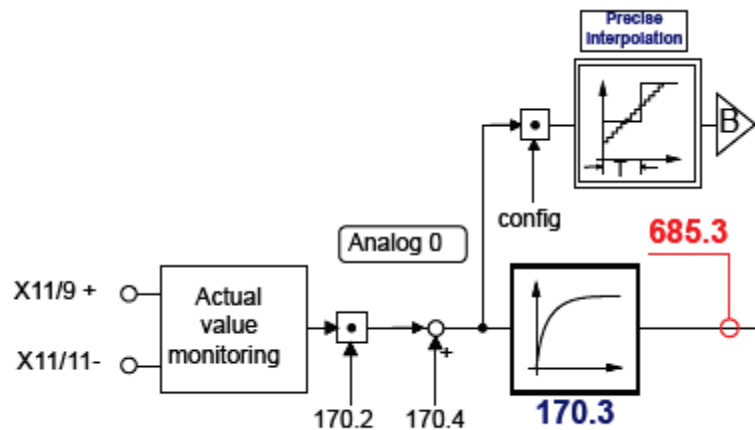

B: Continuative structure image (see on page 224)

The reference to the master is established with the velocity at 10V.

If required the direction of rotation of the master axis read in can be changed.

Time frame signal source master

Averaging and a following filter (interpolation) can help to avoid steps caused by discrete signals.

If the external signal is analog, there is no need to enter a value here (Value = 0).
For discrete signals e.g. from a PLC, the scanning time (or cycle time) of the signal source is entered.

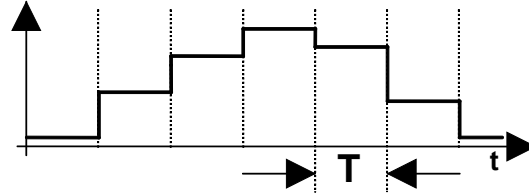

This function is only available if the analog interface +/-10V is used!

4.3 Load control

In this chapter you can read about:

Configuration of load control	154
Error: Position difference between load mounted and motor feedback too high	155
Load control signal image	155

The load control can be activated via an additional feedback system for the acquisition of the actual position of the load.

This helps for example compensate the slip between material and roller or non-linearities of the mechanic parts.

The load position is set to the demand position.

Please note:

- ◆ This function is not available in the C3I10T10 and C3I11T11 devices.
- ◆ As a sensor signal, **Encoder** (see on page 365) with A/B track, Step/Direction signal or SSI - sensor is supported.
- ◆ This controller structure improves the stationary precision at the load after the decay of all control movements.
An increase of the dynamic precision (faster transient response) can in general not be reached with the "load control" structure variant.

Notes on the SSI sensor

- ◆ With Multiturn: Number of sensor rotations with absolute reference
- ◆ Word length: Gives the telegram length of the sensor.
- ◆ Baud rate/step: Max. Transmission rate of the path measurement system.
- ◆ Gray code: Sensor gray code coded yes/no (if no binary coded).

Note:

The absolute position is not evaluated!

It is available in the objects 680.24 (load position) and 680.25 (master position) (C3T30, C3T40).

General requirements for supported SSI feedbacks

- ◆ Baud rate: 350k ... 5MBaud
- ◆ Word length: 8 ... 32 Bit
- ◆ Binary or gray code (start value = 0)
- ◆ Initialization time after PowerOn: < 1,1s
- ◆ Signal layout:

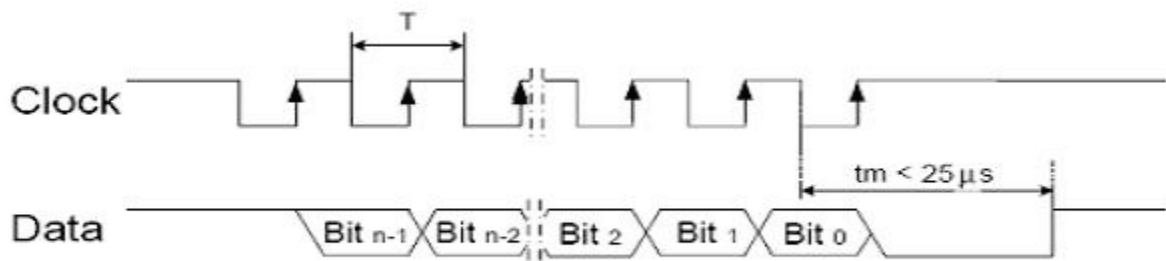

The most significant bit must be transmitted the first!

Caution! Feedback systems, transmitting data containing error or status bits are not supported!

- ◆ Examples of supported SSI feedback systems:
 - ◆ IVO / GA241 SSI;
 - ◆ Thalheim / ATD 6S A 4 Y1;
 - ◆ Hübner Berlin / AMG75;
 - ◆ Stegmann / ATM60 & ATM90;
 - ◆ Inducoder / SingleTurn: EAS57 & Multiturn: EAMS57

4.3.1. Configuration of load control

Configuration in the "configure signal source" wizard under "load feedback system":

- ◆ The selection of the feedback signal activates the acquisition and the signals are available as **status values** (see on page 155).
- ◆ Rotatory or linear feedback systems are supported.
- ◆ Input values for rotatory feedback systems:
 - ◆ Increments per feedback revolution (physical, without quadruplication)
 - ◆ Direction reversal

Attention!With wrong sense of direction and active load control, you will get a positive feedback; the motor will accelerate in an uncontrolled way
Solution: Before the load control is activated, the signals must be checked with the aid of the **status values** (see on page 155) and secured against wrong sense of direction by configuring a "maximum difference to motor position" (O410.6).
 - ◆ Load travel per feedback revolution: Is used for establishing the measure reference between load- and motor position.
The value can be configured very precisely by entering numerator and denominator.
- ◆ Input values for linear feedback system
 - ◆ Feedback resolution (physical, without quadruplication)
Position difference, which corresponds to a cycle duration of the feedback signal.
 - ◆ Direction reversal

Attention!With wrong sense of direction and active load control, you will get a positive feedback; the motor will accelerate in an uncontrolled way
Solution: Before the load control is activated, the signals must be checked with the aid of the **status values** (see on page 155) and secured against wrong sense of direction by configuring a "maximum difference to motor position" (O410.6).
 - ◆ Scaling factor for an additional adaptation of the feedback signal (is normally not required = 1)
 - ◆ Maximum difference to the motor position
Upon exceeding this value, Compax3 will report **error 7385hex** (see on page 155) (29573dec)
 - ◆ Intervention limitation (O2201.13 in % of the reference velocity or reference speed);
only active with position controller I component switched off (O2200.25=0)
You can use this specification in order to limit position correction intervention, i.e. to limit the velocity correction factor resulting from the position difference. This can be especially sensible during the acceleration phase, if the material slips because of too high corrective velocities.
- ◆ Activate / Deactivate load control

Attention!

**The load control is immediately active after the configuration download!
Please do only activate after checking the load position signal (scaling,
direction, value).**

Alignment of the load control:

There is an **Alignment of the position values** of motor and load under the following operating conditions (Load position = Motor position):

- ◆ During a **Machine zero run** the load control is deactivated until the position value 0 (defined via the machine zero offset) was approached. Then an alignment of the position values is performed and the load control is activated.
- ◆ After switching on Compax3.
- ◆ When writing "1" into object 2201.2
- ◆ When activating the load control.

Continuous mode

In continuous operation (object 1111.8 <> 0) an alignment of the position values of motor and load (load position = motor position) takes place upon each new positioning command.

Application: e.g. roller feed

4.3.2. Error: Position difference between load mounted and motor feedback too high

The (unfiltered) position difference between motor feedback and load feedback has exceeded the "maximum difference to motor position" value (O410.6)

The load position in the position controller is deactivated.

In order to re-activate the function (after eliminating the cause of the error), you have the following possibilities:

- ◆ Activate function in configuration and perform configuration download or enter True (-1) into O2201.1
- ◆ Perform Ackn and/or Homing (function becomes effective after homing run).

Caution!

The position difference is aligned to zero when switched on again, i.e. the original position reference is lost. Therefore it is advisable to approach the reference point again in this case (Machine zero run or Homing).

4.3.3. Load control signal image

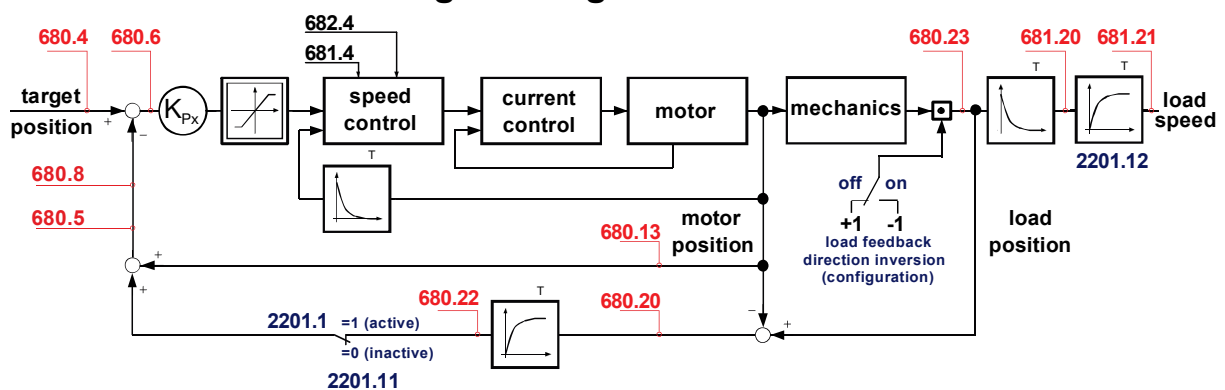

Description of the objects (see on page 295)

4.4 Optimization

- ◆ Select the entry "**Optimization**" in the tree.
- ◆ Open the optimization window by clicking on the "**Optimization Tool**" button.

In this chapter you can read about:

Optimization window.....	156
Scope.....	157
Controller optimization.....	164
Signal filtering with external command value	224
Input simulation	226
Setup mode.....	227
Load identification.....	229
Alignment of the analog inputs.....	231
C3 ServoSignalAnalyzer.....	233
ProfileViewer for the optimization of the motion profile.....	266
Turning the motor holding brake on and off.....	268

4.4.1. Optimization window

Layout and functions of the optimization window

- | | |
|---------------------|--|
| Segmentation | Functions (TABS) |
| Window 1: | ◆ Oscilloscope (see on page 157) |
| Window 2: | ◆ Optimization: Controller optimization |
| | ◆ D/A Monitor (see on page 300): Output of status values via 2 analog outputs |
| | ◆ Scope Settings |
| Window 3: | ◆ Status Display |
| | ◆ Compax3 Error History |
| Window 4: | ◆ Status values |
| | ◆ Commissioning: Setup mode (see on page 227) with load identification (see on page 229) |
| | ◆ Parameters for commissioning, test movements (relative & absolute) and for load identification. |

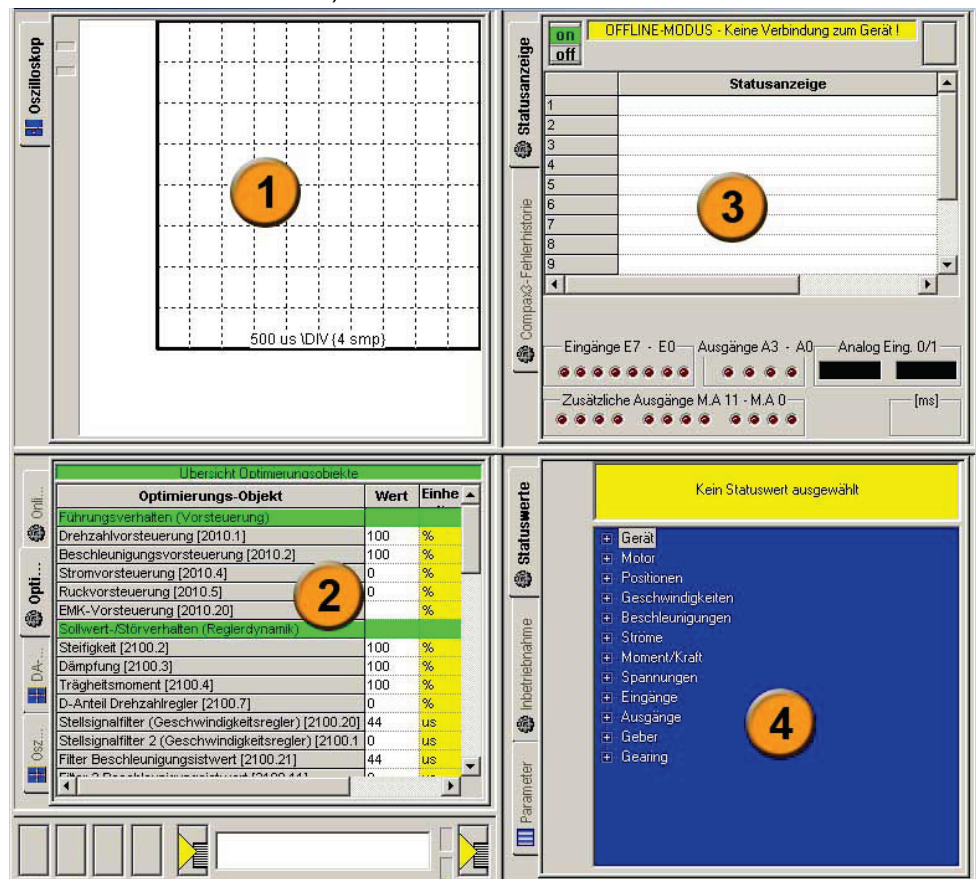

4.4.2. Scope

The integrated oscilloscope function features a 4-channel oscilloscope for the display and measurement of signal images (digital and analog) consisting of a graphic display and a user interface.

Special feature:

In the single mode you can close the ServoManager after the activation of the measurement and disconnect the PC from Compax3 and upload the measurement into the ServoManager later.

In this chapter you can read about:

Monitor information.....	157
User interface.....	158
Example: Setting the Oscilloscope.....	162

4.4.2.1 Monitor information

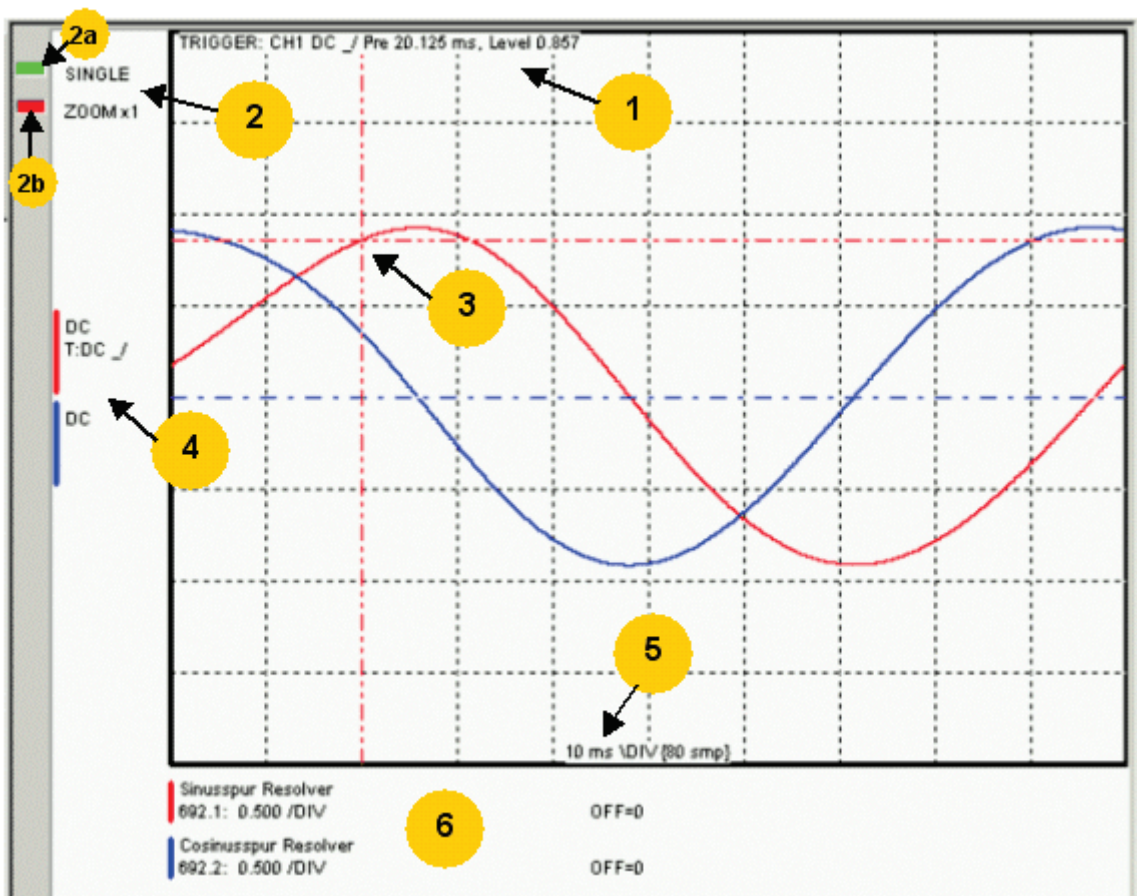





- 1: Display of the trigger information
- 2: Display of the operating mode and the zoom setting
- ◆ 2a: Green indicates, that a measurement is active (a measurement can be started or stopped by clicking here).
- ◆ 2b: Active channel: The active channel can be changed sequentially by clicking here (only with valid signal source).
- 3: Trigger point for Single and Normal operating mode
- 4: Channel information: Type of display and trigger setting; choice of the active channel
- 5: X-DIV: X deviation set
- 6: Single channel sources

Cursor modes -functions

Depending on the operating mode, different cursor functions are available within the osci monitor.

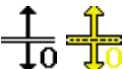
The functions can be changed sequentially by pressing on the right mouse button.

Cursor Symbol	Function
	Set Marker 1 the measurement values of the active channel as well as the Y difference to marker 2 are displayed
	Set Marker 2
	Delete and hide marker
	Move offset of the active channel. The yellow symbol indicates that the scrolling is active.
	Set trigger level and pretrigger

In the ROLL operating mode, marker functions and set trigger level positions are not available.

4.4.2.2 User interface

In this chapter you can read about:

Oscilloscope operating mode switch:.....	159
Setting the time basis XDIV	159
Settings for channels 1..4	160
Trigger settings.....	161
Special functions	161

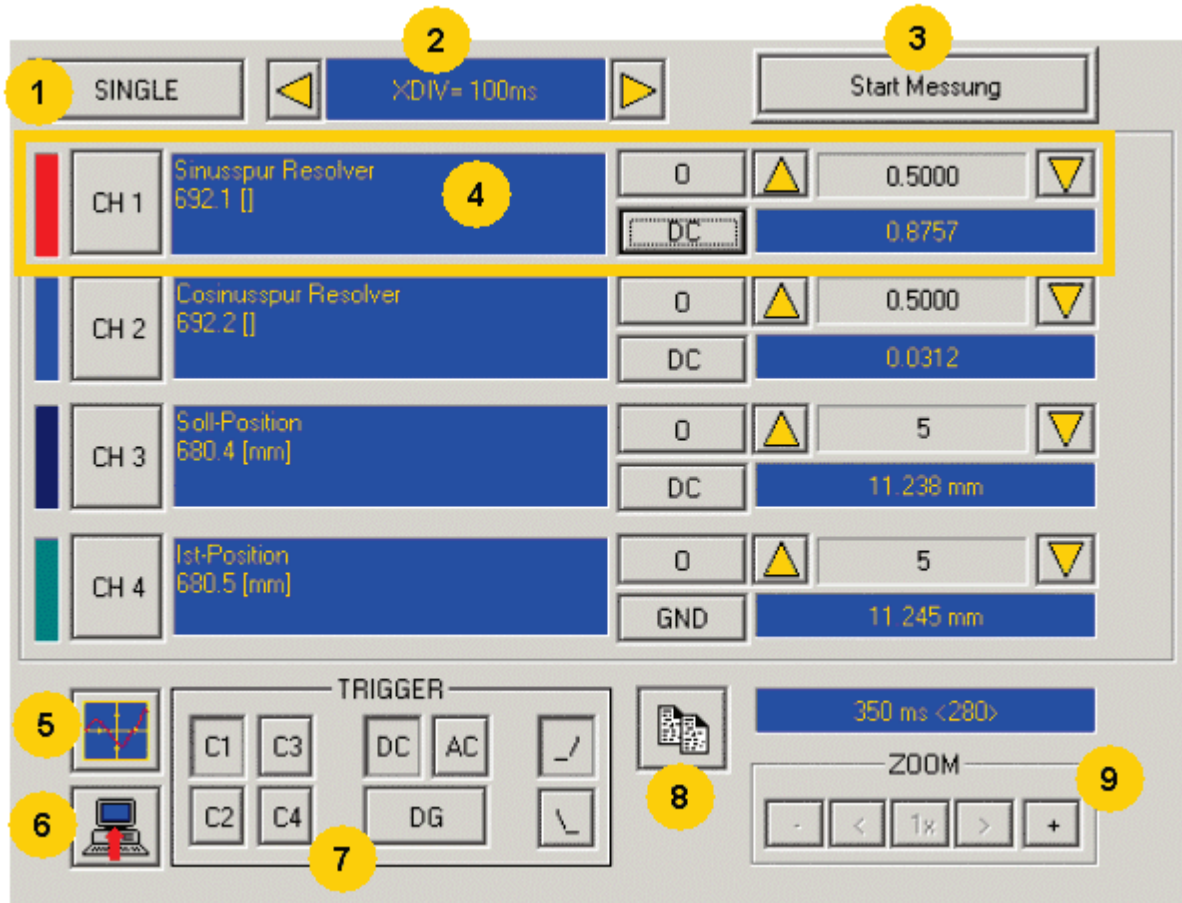

- 1: **Operating mode switch** (see on page 159) (Single / Normal / Auto / Roll)
- 2: **Setting the time basis** (see on page 159)
- 3: Starting / Stopping the measurement (prerequisites are valid channel sources and if necessary valid trigger settings.)
- 4: **Setting channel** (see on page 160) (Channels 1 ..4)
- 5: **Special functions** (see on page 161) (Color settings; memorizing settings and measurement values)
- 6: Loading a measurement from Compax3: in the single mode you can close the ServoManager after the activation of the measurement and disconnect the PC from Compax3 and upload the measurement later.
- 7: **Setting triggering** (see on page 161)
- 8: Copy osci display to clipboard
- 9: Zoom of the osci display (1, 2, 4, 8, 16 fold) with the possibility to shift the zoom window (<,>)

Oscilloscope operating mode switch:

Oscilloscope operating mode switch:

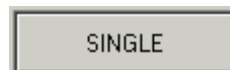

Selection of the desired operating mode: SINGLE, NORMAL; AUTO and ROLL by clicking on this button.

Changing the operating mode is also permitted during a measurement. The current measurement is interrupted and started again with the changed settings.

The following operating modes are possible:

Operating mode	Short description
SINGLE	Single measurements of 1-4 channels with trigger on a freely selectable channel
NORMAL	Like Single, but after each trigger event, the measurement is started again.
AUTO	No Trigger. Continuous measuring value recording with the selected scanning time or XDIV setting
ROLL	Continuous measuring value recording of 1 .. 4 channels with selectable scanning time and a memory depth of 2000 measuring values per channel.

With SINGLE / NORMAL / AUTO, the measurement is made in Compax3 and is then loaded into the PC and displayed.

With ROLL, the measuring values are loaded into the PC and displayed continuously.

Setting the time basis XDIV

Setting the time basis XDIV

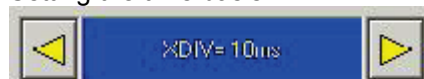

Depending on the selected operating mode, the time basis can be changed via the arrow keys.

For the operating modes **SINGLE**, **NORMAL** and **AUTO**, the following **XDIV** time settings are possible:

XDIV	Scanning time	Samples DIV/TOTAL	Measuring time
0.5 ms	125 us	4/40	5 ms
1.0 ms	125 µs	8/80	10 ms
2.0 ms	125 µs	16/160	20 ms
5.0 ms	125 µs	40/400	50 ms
10.0 ms	125 µs	80/800	100 ms
20.0 ms	1 ms	20/200	200 ms
50.0 ms	1 ms	50/500	500 ms
100.0 ms	2 ms	50/500	1 s
200.0 ms	2.5 ms	80/800	2 s
500.0 ms	10 ms	50/500	5 s
1s	12.50 ms	80/800	10 s
2s	25.00 ms	80/800	20 s
5s	62.50 ms	80/800	50s
10s	125.00 ms	80/800	100 s

For the operating **ROLL**, the following **XDIV** time settings are possible:

XDIV	Scanning time	Samples DIV/TOTAL
400 ms	2 ms	200/2000
1 s	5 ms	200/2000
2 s	10 ms	200/2000
4 s	20 ms	200/2000
10 s	50 ms	200/2000
20 s	100 ms	200/2000
40 s	200 ms	200/2000
100 s	500 ms	200/2000
200 s	1 s	200/2000

Changing the time basis is also permitted during an OSCI measuring sequence. This means, however, that the current measurement is interrupted and started again with the changed settings.

Settings for channels 1..4

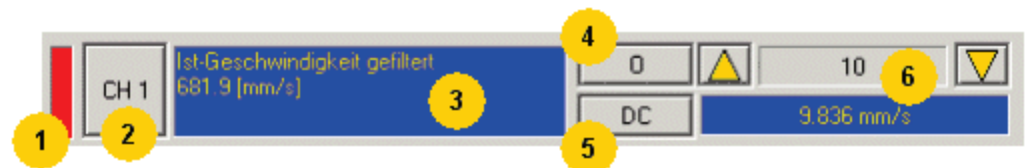

1: Select channel color

2: Open menu for channel-specific settings

- ◆ **Resetting channel CH 1..4:** All channel settings are deleted.
Please note: Channels can only be filled with sources one after the other. It is, for example, not possible to start a measurement which has only a signal source for channel 2!
- ◆ **Select channel color:** Here you can change the color of the channel.
- ◆ **Show/hide channel:** Hide/show display of the channel.
- ◆ **Change logic display mask:** Mask bits in logic display.
- ◆ **Autoscale:** Calculating YDIV and offset: The program calculates the best settings for YDIV and channel offset in order to display the complete signal values optimally.

3: Set signal source with object name, number and if necessary unit

- ◆ Define source: Draw the desired status object with the mouse (drag & drop) from the "Status value" window (right at the bottom) into this area.
Multiple oscilloscope in Compax3M: select device in addition to the object.

4: Set Channel offset to 0**5: Select channel display (GND, DC, AC, DIG)**

- ◆ **DC**: Display of the measurement values with constant component
- ◆ **AC**: Display of the measurement values without constant component
- ◆ **DIG**: Display of the individual bits of an INT signal source.
The displayed bits can be defined via the logic display mask.
- ◆ **GND**: A straight line is drawn on the zero line.

6: Set Y-amplification (YDIV)

Change of the Y amplification YDIV in the stages 1, 2, 5 over all decades.
Arrow upwards increases YDIV, arrow downwards diminishes YDIV.
The standard value is 1 per DIV.
The measurement value of the channel at the cursor cross is displayed.

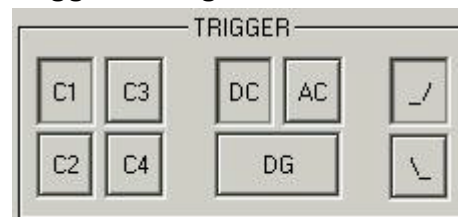
Trigger settings

Select trigger channel: Buttons C1, C2, C3, C4

Select trigger mode: DC, AC, DG

Selecting the trigger edge: Rising_/ or falling \.

The pretrigger as well as the trigger level are set by clicking on the trigger cursor



() directly in the OSCI display.

Special functions

Menu with special oscilloscope functions such as memorizing or loading settings.

Functions:

- ◆ **Select background color**: Adapt background color to personal requirements.
- ◆ **Select grid color**: Adapt grid color to personal requirements.
- ◆ **Memorize OSCI settings in file**: The settings can be memorized in a file on any drive. The file ending is *.OSC.
- ◆ The format corresponds to an INI file and is presented in the appendix.
- ◆ **Open OSCI settings from file**: Loading a memorized set of settings. The file ending is *.OSC.
- ◆ **Memorizing OSCI settings in the project**: Up to four sets of OSCI settings can be memorized in the current C3 ServoManager project. .
- ◆ **Open OSCI settings from project**: If settings were memorized in the project, they can be read in again.
- ◆ **Memorize OSCI measurement in file**: Corresponds to memorizing the setting; the measurement values of the measurement are stored in addition. Thus it is possible to memorize and read measurements completely with settings. The file ending is *.OSM.
- ◆ **Export measure samples to csv file**: e.g. for reading into Excel.

4.4.2.3 Example: Setting the Oscilloscope

SINGLE measurement with 2 channels and logic trigger on digital inputs

The order of the steps is not mandatory, but provides a help for better understanding.

As a rule, all settings can be changed during a measurement. This will lead to an automatic interruption of the current measurement and to a re-start of the measurement with the new settings:

Assumption: A test movement in the commissioning mode is active.

1.) Select OSCI operating mode 

2.) Select Time basis XDIV 

3.) Select channel 1 signal source digital inputs 120.2 from status tree with the aid of Drag & Drop

4.) Select channel 2 (filtered actual speed) via "Drag and drop" from the status tree

5.) Set trigger to channel 1 and DG.

Input of the mask in HEX

Triggering a rising edge to input I1.

BIT 0 (value 1) = I0

BIT 1 (value 2) = I1

BIT 2 (value 4) = I2 etc.

Trigger to input	I0	I1	I2	I3	I4	I5	I6	I7
Trigger mask in hex	1	2	4	8	10	20	40	80

The masks can also be combined so that the trigger is only active, if several inputs are active. Example: Triggering to I2 and I5 and I6 -> 4h + 20h + 40h = 64h

The mask for input I1 is in this case 2.

Select rising edge.

NOTE: If the trigger mask DG (digital) is selected for a channel, the display mode of the trigger channel is automatically set to DIG display.

6.) Start measurement

7.) Set pretrigger in the OSCI window

Note: There is no level for the DIG trigger. The the event limit determines the mask
If a trigger event occurs, the measurement values are captured until the measurement is completed.

Afterwards, the measurement values are read from the Compax3 and displayed.

The display mask of trigger channel 1 was not yet limited, therefore it shows all 16 bit tracks (b0...b15). In order to limit it to 8 bit tracks, you must call up the menu for channel 1 via [CH1] and select "change logic of display mask [H].

Limit the display mask to 8 bit tracks with Mask FFh.

In the display the bit tracks b0 to b7 are now shown:

Example: Only b0 and b1 are to be displayed: Set display mask to 03

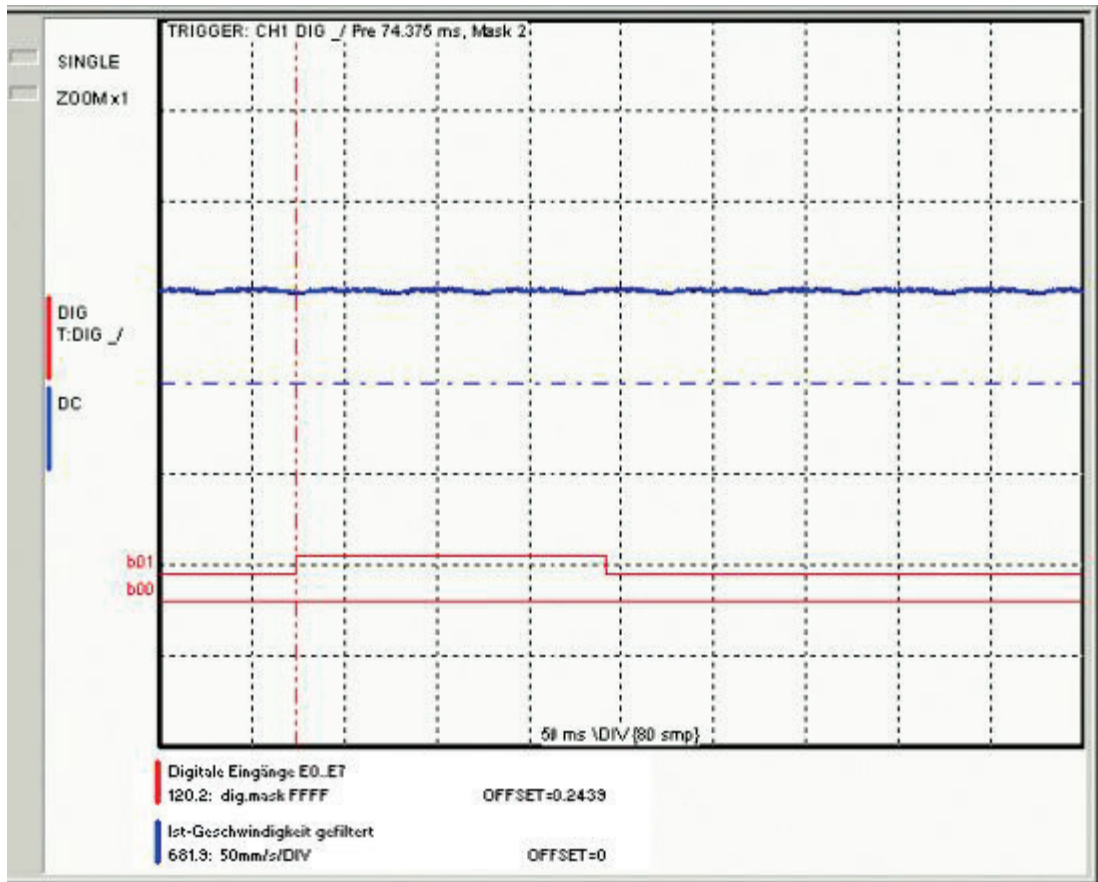

4.4.3. Controller optimization

In this chapter you can read about:

Introduction..... 164
 Configuration..... 166
 Automatic controller design..... 182
 Setup and optimization of the control..... 194

4.4.3.1 Introduction

In this chapter you can read about:

Basic structure of the control with Compax3 164
 Proceeding during configuration, setup and optimization 164
 Software for supporting the configuration, setup and optimization..... 165

Basic structure of the control with Compax3

Compax3 is an intelligent servo drive for different applications and dynamic motion sequences.

Basic structure of a control with the Compax3e servo drive

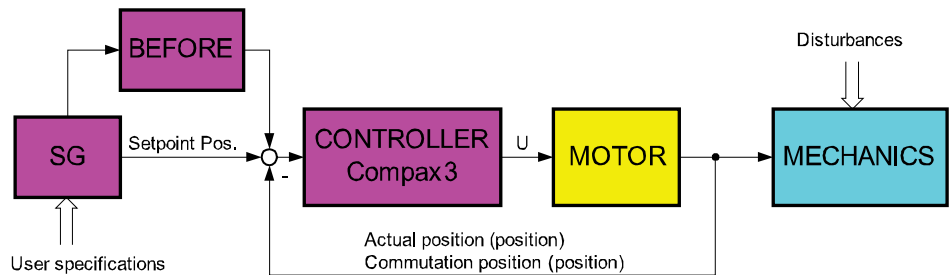

SG: Command value generator
 BEFORE: Feed Forward

As shown in the above figure, the programmed motion sequences are generated by the internal Compax3 setpoint generator. The setpoint position as well as the other status values of the feedforward control are made available to the position controller in order to keep the following error as small as possible. For the control, Compax3 requires on the one hand the actual position and on the other hand the commutation position, which represents the reference between the mechanic feedback position and the motor magnet.

Proceeding during configuration, setup and optimization

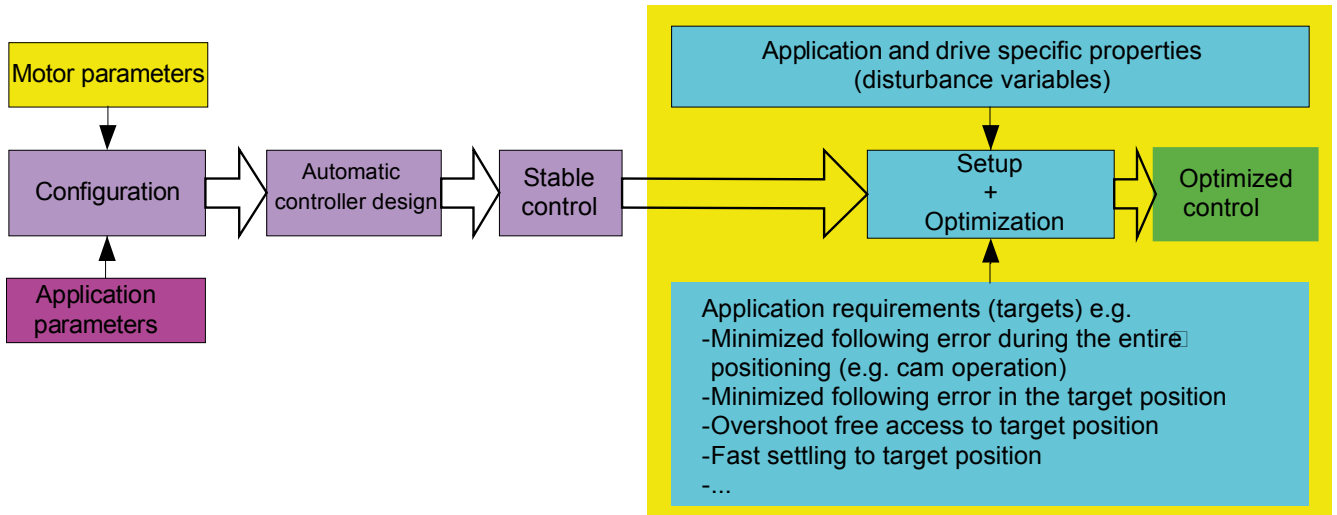

Overview of the processes during configuration and setup of the Compax3 drive system

The controller presettings are calculated from the configured motor and application parameters with the aid of the automatic controller design which runs in the background.

These controller presettings provide normally for a stable and robust control. Due to continually rising application requirements, this presetting is often not sufficient, so that further optimization of the control behavior is necessary.

This manual describes the setup and optimization procedure for Compax3.

In order to better understand the correlations and interactions, we will describe in the first step the individual correlations and physical values, that are required for the configuration and the prespecification of the control loops. In the following, the manual will then describe the function blocks for the optimization implemented in the servo drive as well as the setup tool.

Software for supporting the configuration, setup and optimization

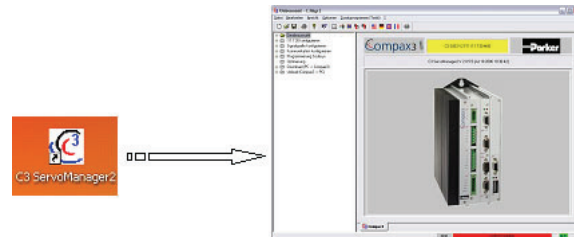

The entry of the motor and application parameters is made with the C3 ServoManager2 (C3Mgr2.exe):

The configuration requires:

Application parameters

The wizard guided entry of the application parameters takes place directly in the ServoManager.

Carefully verify the entries and default values in order to detect entry errors in the run-up.

After the configuration download, the drive can be set up and be optimized if needs be. For this, please open the optimization window of the ServoManager:

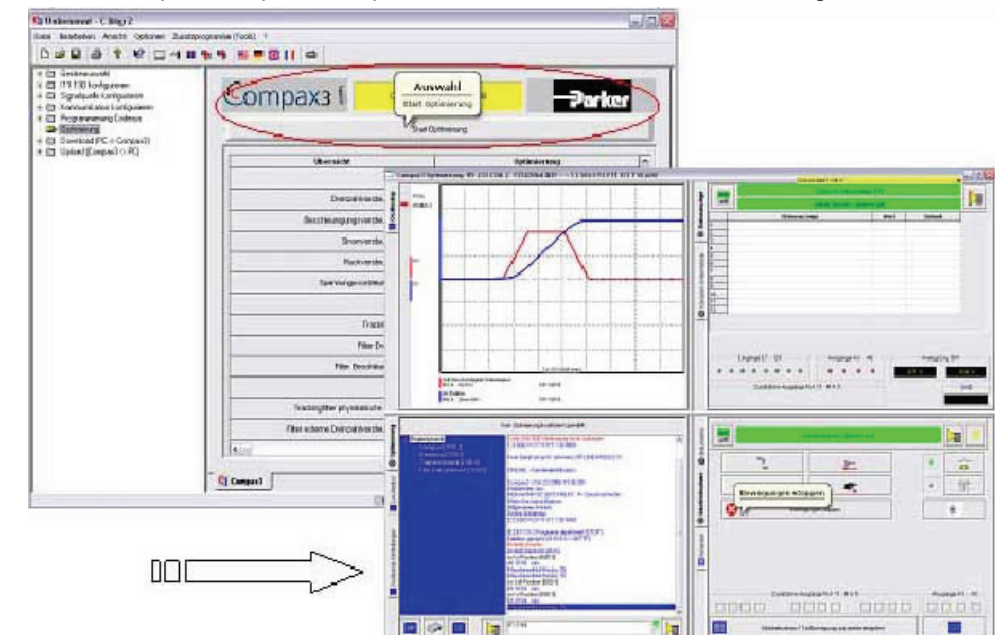

4.4.3.2 Configuration

In this chapter you can read about:

Control path.....	166
Motor parameters relevant for the control	167
Mass inertia.....	167
Nominal point data.....	167
Saturation values.....	169
Quality of different feedback systems	169
Typical problems of a non optimized control	170
Feedback error compensation	171
Commutation settings.....	172
I ² t - monitoring of the motor.....	172
Relevant application parameters.....	175
Asynchronous Motors.....	178

Control path

For the motors, the knowledge of the mathematical model is a prerequisite. Mathematically idealized model of the control path:

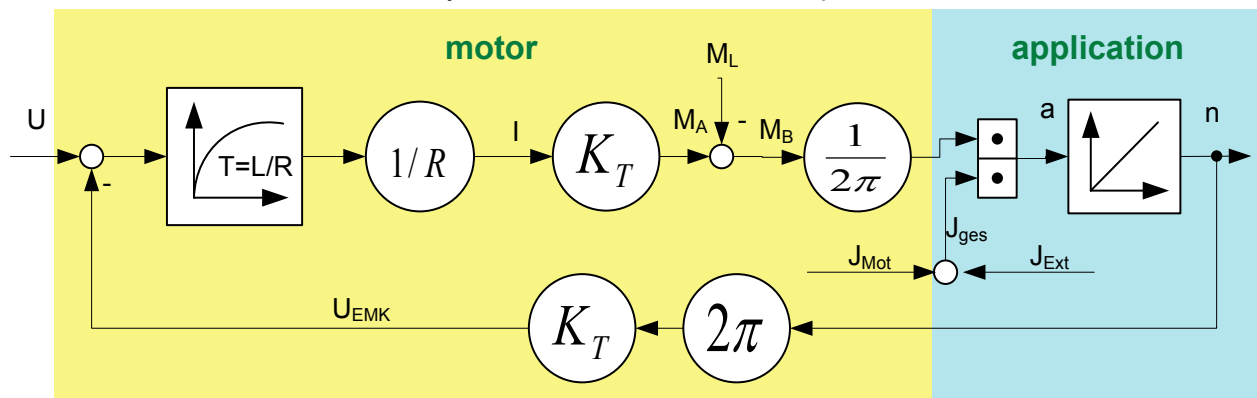

U:	Control voltage
U _{EMK} :	electromagnetically generated voltage in the motor
T:	electric time constant of the motor winding
L:	Winding Inductance
R:	Winding Resistance
M _A :	Drive torque of the motor
M _L :	Load torque
M _B :	Acceleration torque
I:	Actual current r.m.s. (torque-producing)
K _T :	Torque constant
J _{mot} :	Motor mass moment of inertia
J _{ext} :	external mass moment of inertia
J _{total} :	Total mass moment of inertia
a:	Acceleration
n:	Velocity

Explanation:

The motor is controlled by the servo drive with control voltage U. During motion of the motor, an internal back e.m.f. U_{EMC} is induced. This antagonizes the control voltage and is therefore deduced in the motor model. The difference is available for the acceleration of the motor.

The first order delay component represents the delaying property of the motor winding with the time constant T=L/R. According to Ohm's Law, a current I=U/R results.

The drive torque of the motor is calculated by multiplying the current with the motor torque constant K_r. This is antagonized by the load torque of the machine.

The remaining acceleration torque accelerates the motor.

The resulting acceleration depends on the total mass moment of inertia (= motor + load moment of inertia).

The integration of the acceleration (sum of the acceleration over time) results in the velocity of the motor, which influences the amplitude of the induced EMC voltage.

Motor parameters relevant for the control

All motor parameters relevant for the control quality will be explained below. Wizard guided entry of the motor parameters in the MotorManager.

Electromotoric countercheck EMC

A non-energized synchronous motor induces an induction voltage, the so-called EMC voltage during an armature movement.

The EMC constant (motor EMC) states the value of the induced voltage subject to velocity.

The EMC constant corresponds to the motor torque constant K_T , which represents the correlation between the torque-producing current and the drive torque, however in a different unit.

The EMC voltage antagonizes the control voltage of the servo drive.

As the control voltage of the drive is not unlimited, it must be taken into consideration that the drive may approach the voltage limit at high velocities and therefore high EMC voltages.

The EMC constant is important with respect to the velocity control design.

The motor EMC is entered in the "motor characteristics" wizard window of the MotorManager. You may choose between different units. Please note the information on the motor type specification plate.

Mass inertia

The mass moment of inertia (moment of inertia) is also an important motor parameter for the design of the velocity control loop. For the velocity control design, this parameter is effective in correlation with the external mass moment of inertia of the load. The external load is entered in the C3 ServoManager. With the "load identification" function of the C3 ServoManager, the mass inertia can be determined, if it is not yet known.

Nominal point data

In this chapter you can read about:

Motor characteristic line of a synchronous servo motor (torque via velocity) 168

Calculation of the reference current from the characteristic line. 168

The nominal point data can be found in the velocity characteristic line of the motor.

The prespecified nominal point can be changed in the 2nd wizard page of the C3 ServoManager configuration with the aid of "activate change of reference point" via the reference velocity and the reference current.

Motor characteristic line of a synchronous servo motor (torque via velocity)

SMH 60 30 1.4 ...2ID...4: 3000rpm at 400VAC

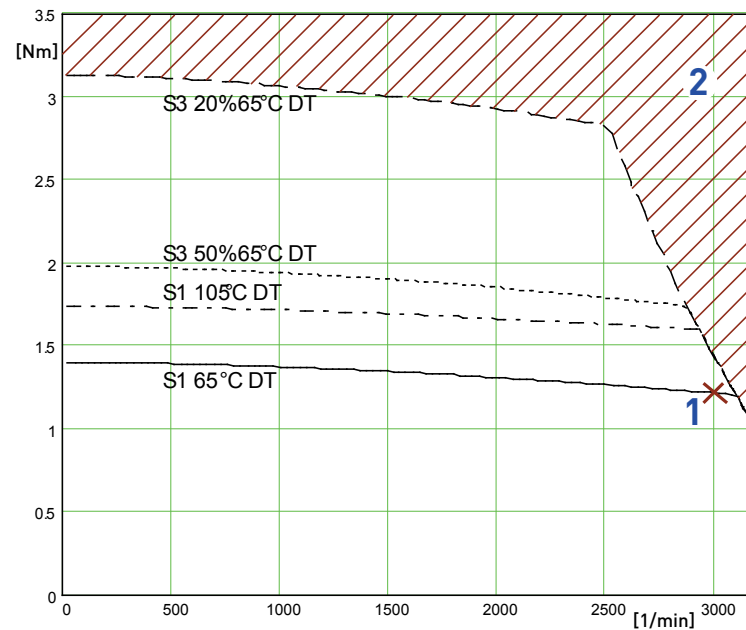

1: Nominal point

2: Forbidden range

Calculation of the reference current from the characteristic line.

$$I = \frac{M[\text{Nm}]}{EMK} \cdot 85,5 = \frac{M[\text{Nm}]}{K_T}$$

or for linear motors

$$I = \frac{M[\text{Nm}]}{EMK_V} \cdot \frac{\sqrt{2}}{\sqrt{3}} = \frac{M[\text{Nm}]}{K_f}$$

In the MotorManager, a motor can be defined for different operating modes (230V, 400V and 480V) without having to create several entities.

Additional parameters of a motor are:

- ◆ Standstill current [mA_{rms}]
- ◆ Pulse current [in % of the nominal current]

The pulse current can be provided by the Compax3 for the duration of the pulse current time (as far as the device current permits). The thermal pulse load of the motor rises due to the pulse current. This pulse load is monitored by the i^2t monitoring in the Compax3.

Saturation values

A motor may show a saturation behavior at higher currents due to iron saturation. This results in the reduction of the winding inductance at higher currents. As the inductance value of the winding enters directly into the P term of the current controller, the saturation at higher currents will result in too fast current control. This behavior can be counter steered with saturation values (entered in the "motor characteristics" wizard window of the MotorManager).

Consideration of the saturation values with the aid of a linear characteristic line

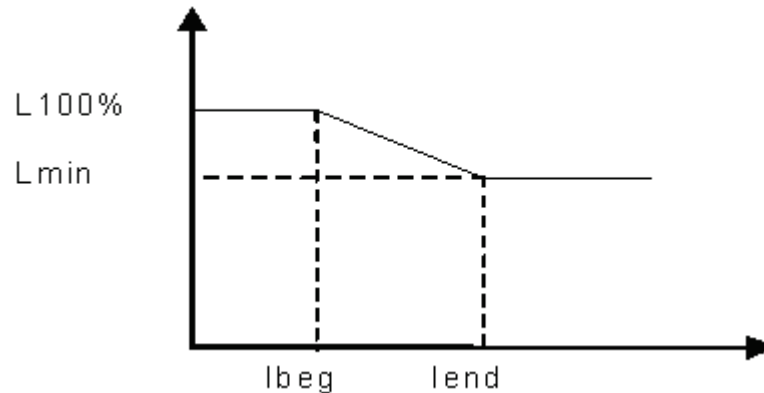

- L 100% Entered value of the nominal inductance
- Lmin Minimum winding inductance [% of the nominal inductance].
- Ibeg Value to which the inductance of the winding sinks at Ifinal.
- Ifinal End of the saturation [% of the nominal inductance].

For the determination of the saturation values please see chapter 0 (see on page 224, see on page 225).

Quality of different feedback systems

In this chapter you can read about:

Interface	169
Resolution	169
Noise	170

The controller quality depends to a great extent on the signal quality of the position feedback and its signal acquisition. It is therefore important to select a suitable measurement system for the individual application.

In the rotary range, a resolver is mostly used for reasons of economics. The single pole resolver provides one sine/cosine period per revolution. In very demanding applications, the performance of the resolver is often not satisfactory, so that a SinCos feedback with a higher resolution must be used. The typical resolution of a SinCos feedback is 1024 periods/revolution.

Other position feedbacks which are often used in the linear range, differ with respect to the reading principle. High-quality optical position measuring systems offer the highest resolution and accuracy.

Interface

An additional distinctive feature is the electric interface between servo drive and feedback. Analog sine/cosine signals or digital encoder signals (RS422 standard) are used to transmit the incremental position information. Due to the high interpolation rate (approx. 14 bits) of the Compax3 servo controller, an analog sine/cosine signal is in most cases preferable to digital encoder signals.

Resolution

The less precise the resolution, the higher the quantization noise on the velocity signal.

Noise

The feedbacks have different levels of analog noise, which have a negative effect on the control. The noise can be dampened with the aid of filters in the actual value acquisition, however at the cost of the controller bandwidth.

For comparison, the noise of the actual velocity value at standstill of two different feedbacks is displayed.

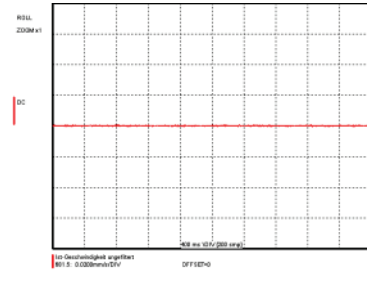
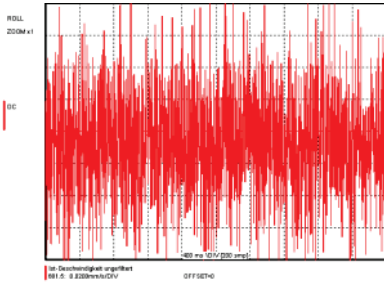

Typical problems of a non optimized control

In this chapter you can read about:

Too high overshoot on velocity 170
 Increased following error 170
 Instable behavior 171

Upon first setup of a control, the controller is normally not able to meet all application requirements at once. Typical problems may be:

Too high overshoot on velocity

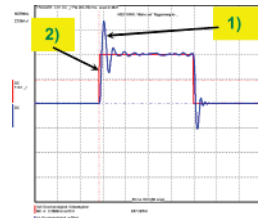

- 1) Actual velocity
- 2) Setpoint velocity

Increased following error

Increased following error when approaching the target position or the reduction of the following error takes too long

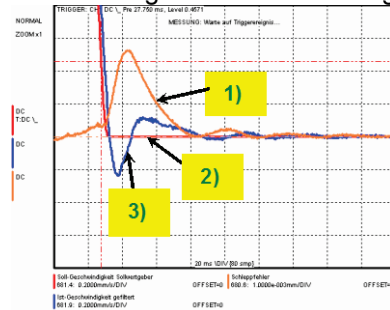

- 1) Following error
- 2) Setpoint velocity
- 3) Actual velocity

Instable behavior

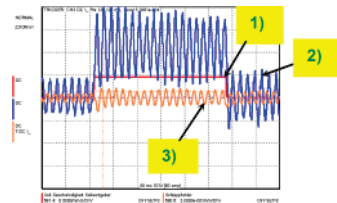

- 1) Setpoint velocity
- 2) Actual velocity
- 3) Following error

Feedback error compensation

Feedbacks with sine/cosine tracks may have different errors. The feedback error compensation supported by Compax3 eliminates offset and gain errors on both tracks online.

The feedback error compensation is activated in the MotorManager: "Feedback system" wizard under "feedback error compensation".

Without compensation

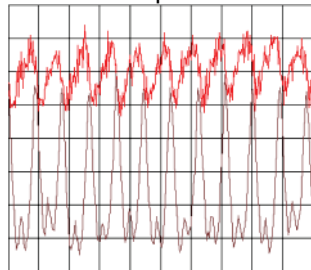

top: Actual current value
bottom: Actual speed value

With compensation

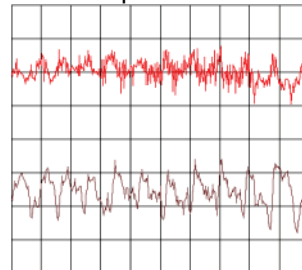

Scale:
Current = 50mA/Div
Speed = 0.2mm/s/Div
Time = 3.8ms/Div

Type of motor: Parker LMDT 1200-1 ironless linear motor
Linear encoder: Renishaw RGH 24B with 20µm resolution
Servo drive: Compax3

In order to accept the changes in the MotorManager in the project, the individual configuration pages must be clicked through. In order to make the changes made in the MotorManager effective in the device, the configuration download in the C3Manager must be executed.

In the event of formal errors, the feedback error compensation may however be disadvantageous; therefore it is switched off as a default.

Commutation settings

Another prerequisite for a good control quality is the correct motor commutation of the motor. This comprises several settings.

- ◆ The commutation angle describes the relation of the feedback position with respect to the motor pole pair position.
- ◆ Commutation direction reversal describes the correlation between the position of the feedback and the commutation position.
- ◆ Feedback direction reversal describes the direction correlation between the defined positive direction of the drive and the feedback position.
- ◆ If the commutation direction does not match the defined direction of rotation, this will result in a subsequent error with the error message "following error" or "motor stalled".
- ◆ A faulty commutation angle value results in increased current and following error. Therefore the voltage limit is reached faster. If the value of the commutation error exceeds 90°, the motor will spin due to the positive feedback effect.

These 3 settings can be automatically acquired with the MotorManager.

With the aid of the automatic commutation acquisition, the commutation settings can be determined and plausibility checks can be made. You will be guided through the individual wizard pages and the MotorManager will issue a prompt to define the positive direction of the drive. The wizard pages supporting the user depend on the feedback system as well as on the motor type (linear or rotary).

This function is activated in the MotorManager:

"Feedback system" wizard under "automatic commutation settings".

Note The motor should be operated without load (=> no load torque e.g. weight force of a z-axis).

Additional setting of the commutation for incremental feedback:

This function is activated in the MotorManager:

"Feedback system" wizard under "feedback resolution".

In the event of an incremental feedback (Sine/cosine or RS424 encoder) the commutation must be defined in addition, in order to find the position reference to the winding.

- ◆ Automatic commutation with movement
- ◆ Commutation with digital hall sensors

I²t - monitoring of the motor

In this chapter you can read about:

Motor continuous usage:	172
Motor pulse usage	174
Reference point 2: Increased torque thanks to additional cooling.....	174

With the I²t - monitoring, the motor is protected against overload or thermal destruction. For this, knowledge on the load bearing capacity of the motor is required. This information can be taken from the manufacturer documentation (motor parameters). Compax3 monitored:

- ◆ Continuous usage of the motor (motor usage)
- ◆ Pulse usage of the motor (motor pulse usage)

Motor continuous usage:

This kind of monitoring watches over the continually deliverable torque (continuous current). This continuous current depends on the velocity and is acquired online from the linearization of the motor characteristic line.

Linearized motor characteristic lien for different operating points

Nominal point

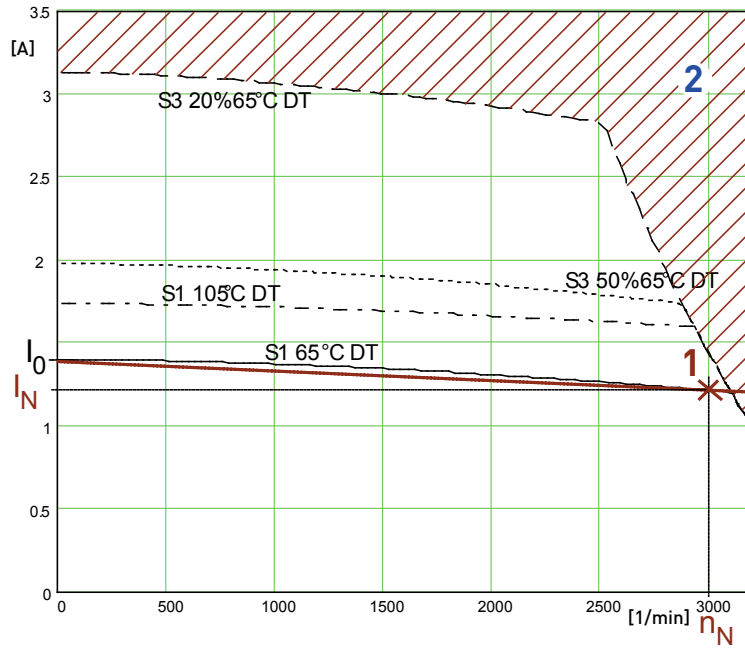

- I_0 : Standstill current
- 1: Nominal point
- I_N : Nominal current (defined in the MotorManager)
- n_N : Nominal Speed
- 2: Forbidden range

For monitoring the continuous utilization, the linearized characteristic line between I_0 and I_N / n_N is used as a threshold.

Reference point 1: higher velocity at reduced torque

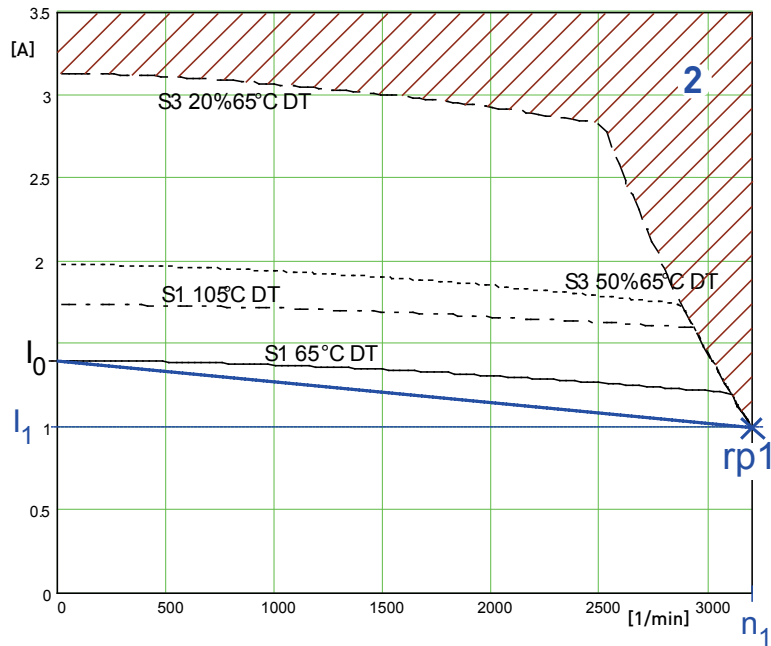

- i_0 : Standstill current
- rp1: Reference point 1 (defined in the C3 ServoManager)
- i_1 : Reference current to reference point 1
- n_1 : Reference velocity to reference point 1
- 2: Forbidden range

For monitoring the continuous usage, the linearized characteristic line between i_0 and i_1 / n_1 is used as a threshold.

Motor pulse usage

This monitoring watches over the duration of the defined pulse current. The permitted duration for the pulse current is defined by the pulse current time constant.

If the acceleration current exceeds the nominal current for a defined time t_1 , a sufficient break time t_2 is required. If the current remains in average above the nominal current, the "monitoring motor pulse usage" [0x7180] error is triggered. Upon a high pulse usage, the error will occur almost without delay.

Current cycle:

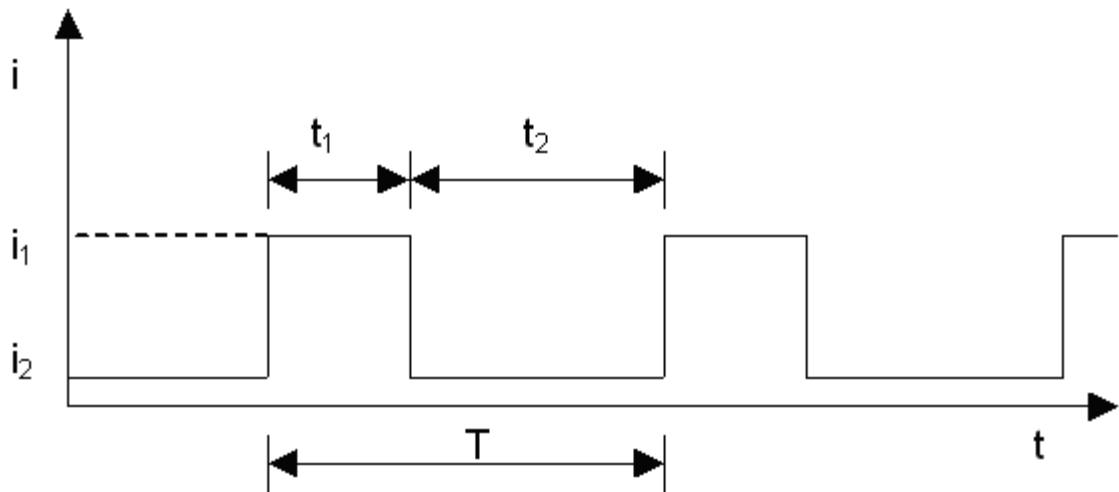

Reference point 2: Increased torque thanks to additional cooling

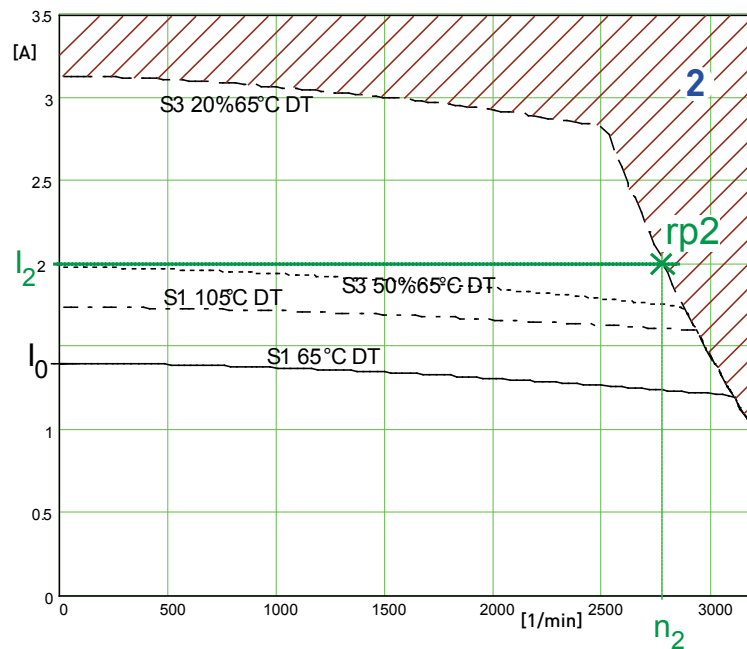

- I_0 : Standstill current
- 1: Nominal point
- rp2: Reference point 2 (defined in the C3 ServoManager)
- I_2 : Reference current to reference point 2
- n_2 : Reference velocity to reference point 2
- 2: Forbidden range

In order to monitor the continuous usage, the velocity-idenpendent current limit I_2 is used.

If a r.m.s. current over the valid straight flows continually in the motor, the I^2t monitoring will issue the "effective motor current monitoring" error message [0x5F48]. The period of time until the error occurs depends on the thermal time constant of the motor defined in the motor parameters. The electronic temperature monitoring simulates approximately the temperature behavior of the motor. By defining a reference point different from the motor nominal data, the I^2t monitoring of the motor can be adapted to changed thermal ambient conditions (e.g. air stream caused by a ventilator fan).

Relevant application parameters

In this chapter you can read about:

- Switching frequency of the motor current / motor reference point..... 175
- External Moment of Inertia..... 177
- Limit and monitoring settings 178

Application parameters relevant for the control (C3 ServoManager)

Compax3 is configured with the aid of the C3 ServoManager. Here you can make application dependant settings. Among these are also parameters, that are relevant for the control. They will be explained below.

Switching frequency of the motor current / motor reference point

In this chapter you can read about:

- Following Error (Position Error)..... 175
- Reduction of the current ripple..... 176
- Motor parameters 176
- Changing the switching frequency and the reference point 177

The higher the switching frequency, the better the quality of the current control. The higher switching frequency reduces the dead time of the current control path as well as the current control noise. Furthermore, thermal losses caused by current ripple are reduced at higher switching frequencies.

Following Error (Position Error)

Too high following error (position error) during a movement

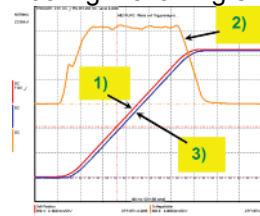

- 1) Setpoint Position
- 2) Position deviation = following error
- 3) Effective position

Reduction of the current ripple

Reduction of the current ripple of the phase current due to the higher switching frequency

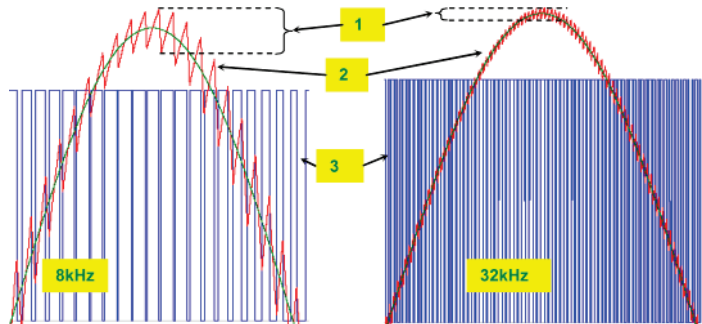

- 1: Current ripple
- 2: Phase current
- 3: PWM control

Hint Please note that a high switching frequency means also high switching losses in the power output stage of the controller. For this reason, you must consider derated data of the servo controller for the drive design with higher switching frequencies.

Motor parameters

In this chapter you can read about:

Parker Motor.....	176
Other motor	176
Motor types supported.....	177

Parker Motor

If a Parker motor is used for the application, the parameters are already contained in the installed software. You can just select one of the available motors from the first configuration page.

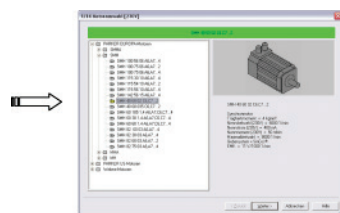

Other motor

When using a motor from a different manufacturer, you will have to enter the relevant data. This process is supported by the MotorManager software tool, which can be called up from the ServoManager:

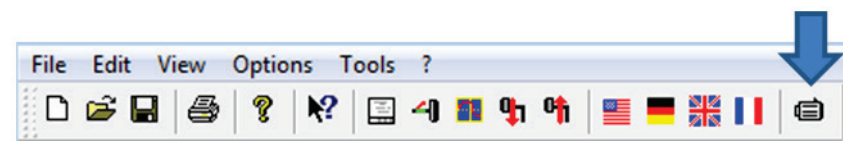

After double clicking on "new", the individual motor parameters are queried by the MotorManager.

Be careful to respect the units of the individual parameters when making your entries!

Furthermore you can use the MotorManager to edit motors already available. In addition, the import and export of motor data entities in XML format is supported.

Motor types supported

Compax3 supports the following motor types:

- ◆ Permanently excited synchronous rotary motors
- ◆ Permanently excited synchronous linear motors
- ◆ Asynchronous rotary motors

In general, rotary and linear motors do have the same signal flow chart. The difference consists solely in the basic physical values, which refer to circular movement resp. the linear motion laws of physics. For this, the following analogies can be established:

Rotary drive [unit]		Linear drive [unit]	
Travel x	[rev]	Path x	[m]
Mass moment of inertia J	[kgm ²]	Mass m	[kg]
Velocity n	[rps]	Velocity v	[m/s]
Angular velocity ω	[1/s]		
Torque constant Kt	[Nm/Arms]	Force constant KF	[N/Arms]
Torque M	[Nm]	Force F	[N]

For reasons of clarity, we will in the following refer to the rotary motor, which will represent both drive types.

An asynchronous motor is set up in the same way as a synchronous motor. The only differences are varying motor parameters.

Changing the switching frequency and the reference point

The switching frequency and the reference point are activated in the ServoManager: "Motor reference point" wizard

A reference point differing from the nominal data may also be entered on the wizard page displayed above.

Please activate "activate changing the reference point", then you may enter the new reference velocity as well as the new reference current.

Motor reference point

A reference point differing from the nominal data may also be entered on the wizard page displayed above.

Please activate "activate changing the reference point", then you may enter the new reference velocity as well as the new reference current.

External Moment of Inertia

The external mass moment of inertia is set against the moment of inertia of the rotor to form the total moment of inertia. The total moment of inertia is used for the controller design.

If you do not know or have only a vague knowledge of the external mass moment of inertia, the mass inertia can be determined via the load identification.

Configuration of an unknown external mass inertia:

The load identification is activated in the ServoManager:

Wizard "External moment of inertia" "unknown: Using default values".

The correct values can be determined later via the load identification!

Limit and monitoring settings

On the "limit and monitoring settings" wizard page, you can set among others the current and velocity limits in % of the nominal values. The nominal values are motor parameters resulting from the motor library or from shifting the reference point on the "motor reference point" wizard page.

Limit and Monitoring Settings wizard page:

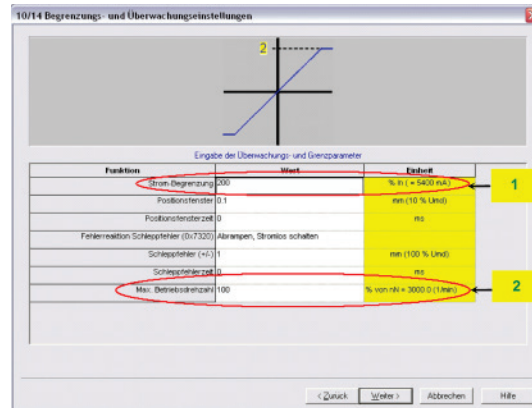

- 1: Current (Torque) Limit
- 2: Velocity limit

Asynchronous Motors

In this chapter you can read about:

Type specification plate data	178
Replacement switching diagram - data for a phase.....	178
Slip Frequency	179
Saturation behavior	179
Cut-off frequency for the field weakening range	180
Rotor time constant	180
Determination of the commutation settings	180
Asynchronous motors: Extension of the controller structure.....	181

Type specification plate data

On the 2nd. wizard page of the Compax3 MotorManager, the type specification plate data must be entered.

Replacement switching diagram - data for a phase

This data can be obtained from the manufacturer or be determined by measurement.

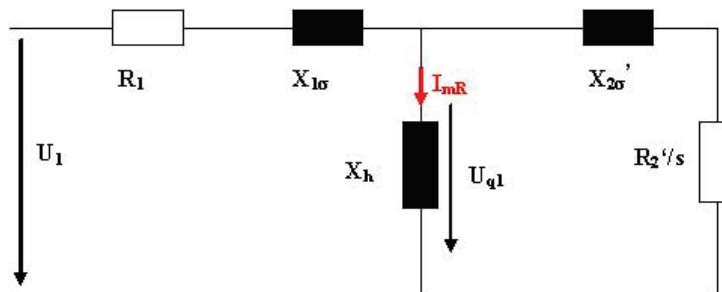

U1:	Nominal phase voltage
R1:	Stator leg resistance
$X1\sigma=2\pi fL1\sigma$:	Leak reactance (for f=50Hz mains frequency)
L1σ:	Stator leakage inductance
$Xh=2\pi fLh$:	Main reactance (for f=50Hz mains frequency)
LH:	Main field inductance
$X2\sigma'=2\pi fL2\sigma$:	Referenced leak reactance (for f=50Hz mains frequency)
L2σ:	Rotor leak inductance
R2':	Referenced carriage resistance
ImR:	Magnetizing current

Slip Frequency

The slip frequency is stated in [Hz electrical] or in [%] and can be determined as follows

$$f_2[\text{mHz (electrical)}] = (f_s \cdot 60 - N_{\text{Nominal}} \cdot P/2) / N$$

$$f_2[\text{mHz}(el.)] = \frac{f_s \cdot 60 - N_{\text{Nenn}} \cdot \frac{P}{2}}{f_s \cdot 60} \cdot f_s \cdot 1000 = \left(f_s - N_{\text{Nenn}} \cdot \frac{P}{120} \right) \cdot 1000$$

$$f_2[\text{Pr omille}] = \frac{f_s \cdot 60 - N_{\text{Nenn}} \cdot \frac{P}{2}}{f_s \cdot 60} \cdot 1000$$

$$\frac{f_s \cdot 60 \cdot 2}{N_{\text{Nenn}}}$$

Whereas P = value before the point of the term è

- f_s: Synchronous nominal frequency (dimensioning base)
- N_{Nom}: Nominal speed in rpm
- f₂: Slip frequency in mHz (electrical)

Saturation behavior

The saturation of the main field inductance can be considered with the help of the following characteristic.

Activate the "consider saturation values" checkbox.

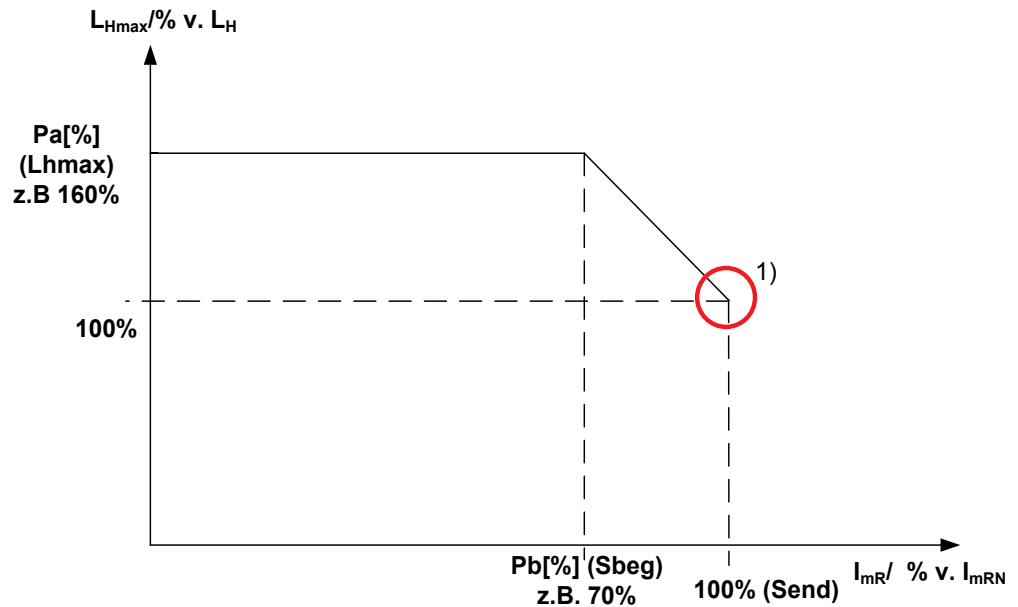

- 1) Nominal point in the basic speed range
- L_{hmax}: max. main field inductance
- Sbeg: Beginning of Saturation
- Send: End of Saturation

Cut-off frequency for the field weakening range

The statement of the cut-off speed defines the beginning of the field weakening operation. From the cut-off speed on, the magnetization current and thus the force constant of the motor are reduced inversely proportional to the speed; the motor is operated in the field weakening range. In the field weakening range, the shaft power produced remains constant.

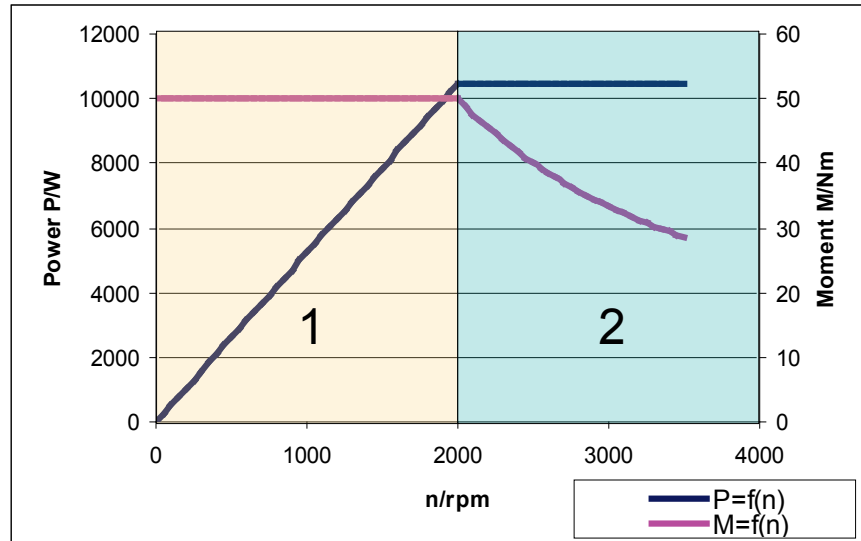

- 1: Basic speed range
2: Field weakening range

Rotor time constant

If the value of the rotor time constant is not known, it can be approximated automatically.

Determination of the commutation settings

On the last wizard page of the Compax3 MotorManager, the commutation settings (feedback direction reversal and commutation direction reversal) can be determined automatically.

Asynchronous motors: Extension of the controller structure

Structure of the magnetization current controller and determination of the slip frequency:

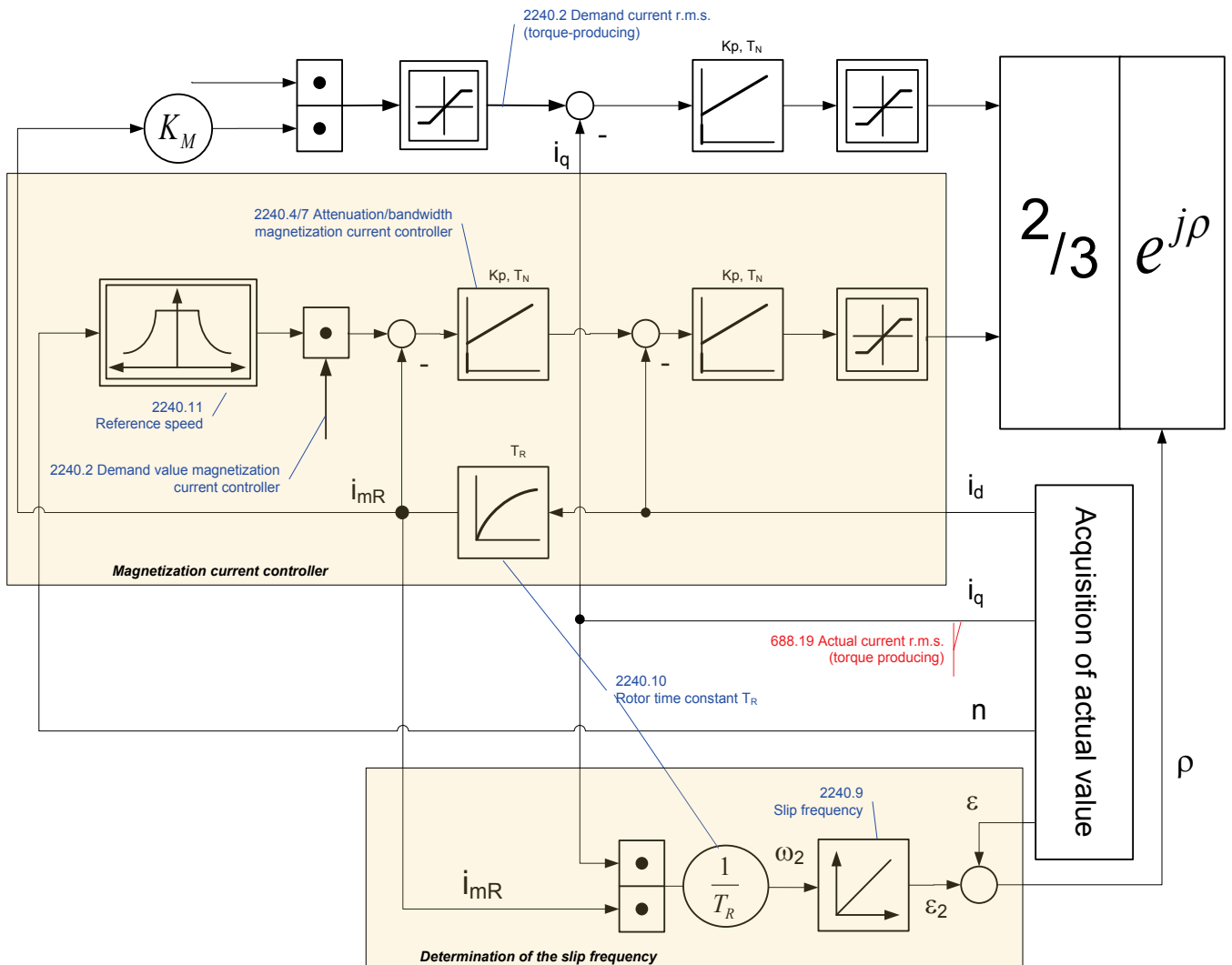

4.4.3.3 Automatic controller design

In this chapter you can read about:

Dynamics of a control	182
Cascade control.....	188
Rigidity	189
Automated controller design	191
Controller coefficients	192

Dynamics of a control

In this chapter you can read about:

Structure of a control	182
Oscillating plant	182
Stability, attenuation	182
Velocity, bandwidth.....	183
Setpoint and disturbance behavior of a control loop.....	186
Response	188
Limitation behavior	188

A change in the input value of a dynamic transmission element causes a change of its output value. The change of the output value is however not immediately effective, but takes a certain time, the transient response. The course of the transient response is characteristic for certain kinds of transmission behavior. For this reason, a complete description of the transmission properties of a control comprises the stationary behavior (all setpoint, actual and disturbance values in settled state), as well as the dynamic behavior.

Structure of a control

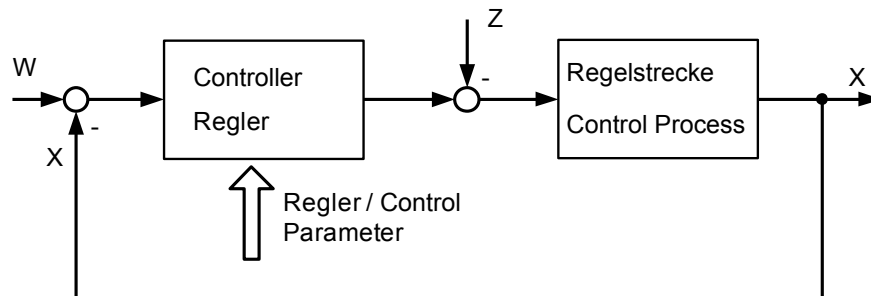

The basic task of a control is the generation and maintaining of a desired state or sequence in spite of interfering disturbances. It is essential that the effects of the disturbances are balanced with the correct force and at the correct time. In the above figure, the setpoint value W represents the desired state and the disturbance value Z represents the interfering disturbance. The actual value X represents the generated and maintained state.

Oscillating plant

Oscillating control paths are control paths that respond with attenuated or unattenuated oscillation to an abrupt change in the setpoint value. Part of this class are for instance:

- ◆ Linear actuators with toothed belts, as a toothed belt represents an elasticity.
- ◆ A mechanic shaft with an external mass moment of inertia, as the shaft represents an elasticity due to its torsional properties.

In general this kind of elasticity is due to a high ratio between J_{Load}/J_{Motor} , as the shaft is normally not designed for this high external load and which may lead to a considerable distortion.

Stability, attenuation

In this chapter you can read about:

Stability problem in the high-frequency range:	183
Stability problem in the low-frequency range:.....	183

In general, two stability problems may occur in a servo drive control:

Stability problem in the high-frequency range:

The "control structure" figure shows that the reverse effect in the control loop (negative feedback) is a prerequisite for the functioning of a control system. Due to the delay in signal transmission, the effect of the negative feedback is diminished or even compensated. The reason is that the corrective measures of the controller are also delayed in the event of delayed signal transmission. This results in a typical oscillating course of the control variable. In the worst case, the deviation of the control variable and the effect of the corrective measures get in phase, if the delays reach a defined value. The negative feedback passes into positive feedback. If the product of the gain factors of all control loop components is higher than 1, the oscillation amplitude will continually rise. In this case the control loop is unstable. In the total gain of 1 the oscillation keeps its amplitude and the control loop is within the limits of stability. The transient response can be characterized by the attenuation and the transient time (velocity).

Step response of a stable controller and of a controller approaching the stability limit

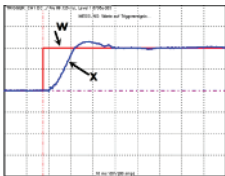

Rugged
Well attenuated

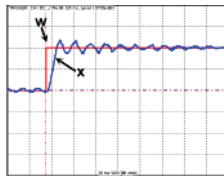

Rugged
Poorly attenuated

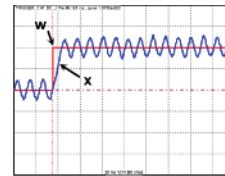

Stability limit
not attenuated

W: Setpoint value
x: Actual value

Stability problem in the low-frequency range:

In this case the controller was set for a very inert control path, while the actual control path is much more dynamic. The controller reacts to a disturbance variable with a much too strong corrective measure so that the disturbance variable is overcompensated and even an increasing oscillation may be the result. In this case the mechanic system of the control path may be destroyed.

Velocity jerk response (low-frequency stability limit)

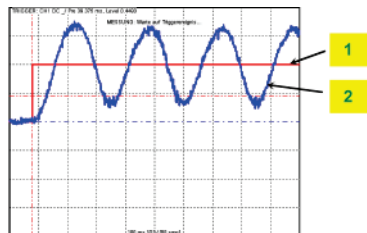

1: Setpoint speed value
2: Actual speed value

Velocity, bandwidth

In this chapter you can read about:

P-TE - Symbol 184
 Step response of a delay component..... 184
 Approximation of a well-attenuated control loop..... 184
 Frequency response of the P-TE component (value and phase)..... 185

A well attenuated control loop can, under certain conditions, be approximated in order to simplify the controller design with a first order delay component (P-TE component) with the replacement time constant TE and the total gain Kp. A P-TE component represents a first order delay component and is a simple dynamic basic component.

P-TE - Symbol

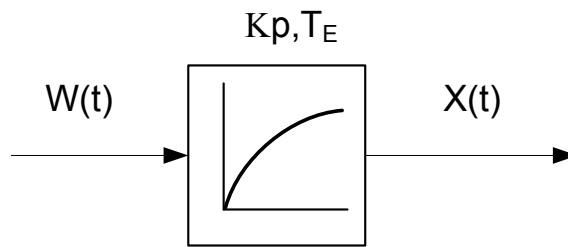

Step response of a delay component

Step response of a first order delay component with $K_p=1$ and $T_E=2.0s$

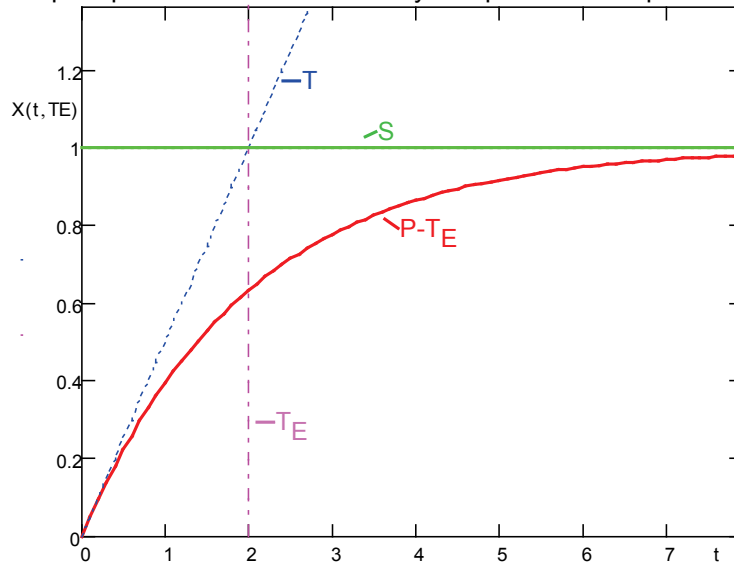

T: Tangent

S: Input jerk

P-TE: Output value of the P-TE component

TE: Time constant of the P-TE component

The definition of the delay time constant is displayed in the above figure. The time of intersection of the tangent and the jerk function itself is by definition the delay time constant (called filter time constant for filters) of a P-TE component. At this point in time the value of the step response is approx. 63% of the final value. In practice the step response corresponds, for instance, to the voltage charge curve of a capacitor.

Approximation of a well-attenuated control loop

The approximation of a well-attenuated control loop is based on the sameness of the control surface of the ideal first order delay component (P-T1 component) and the approximated system (P-TE component).

The control surface is a measure for the velocity of a system and is defined in the following figure. If the surface of the approximated system corresponds to the surface of the ideal system, the approximated system can be described, up to a certain frequency, with the transmission function of the P-T1 component.

Determination of the control surface from the transmission behavior of a P-TE component.

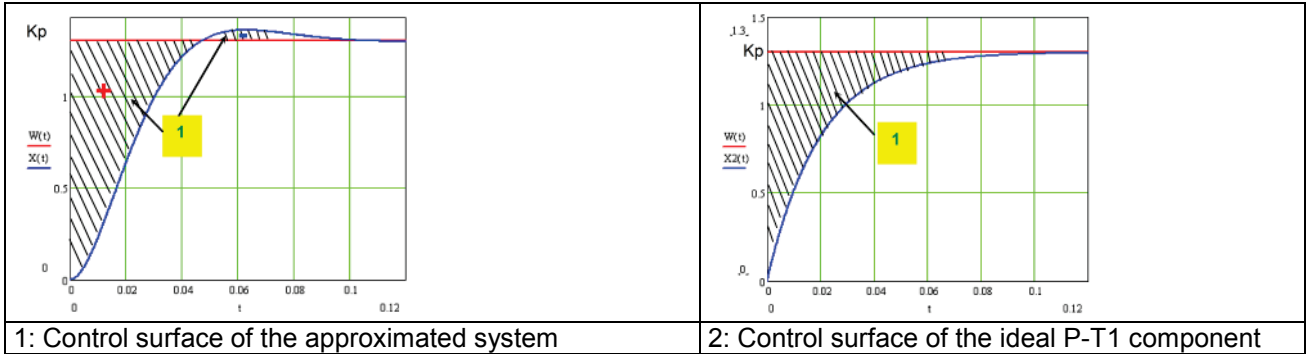

1: Control surface of the approximated system

2: Control surface of the ideal P-T1 component

The velocity of a dynamic system can also be described in the frequency range. In the frequency range, the system behavior is analyzed to sinusoidal inputs signals of different frequencies (frequency response).

Input and output signals of a dynamic transmission component at a defined frequency $f=f_1$

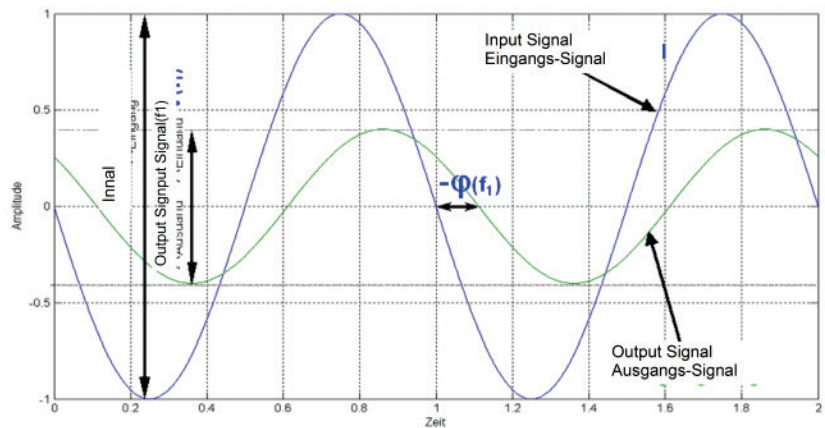

The bode diagram represents the behavior of a dynamic system (in our case of the P-TE component) against the input signal frequency with respect to amplitude and phase.

Frequency response of the P-TE component (value and phase)

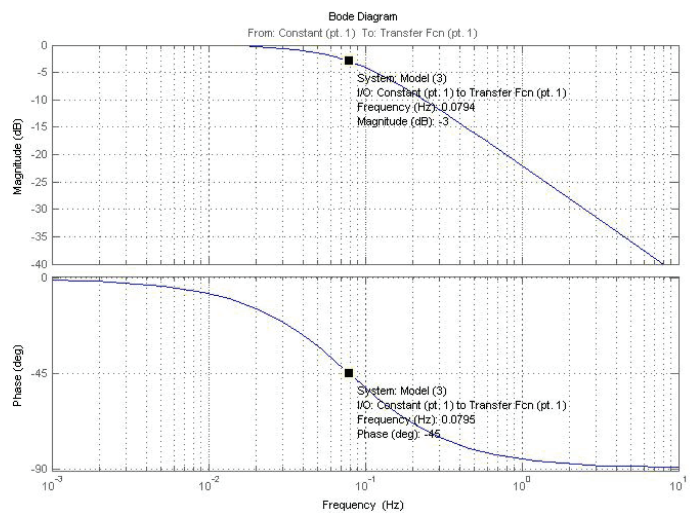

Cut-off frequency

$$f_0 = \frac{1}{2\pi \cdot T_E} = 0,0795 \text{ Hz}$$

is the frequency where the input signal is attenuated by 3dB (-3dB attenuation). The phase shift between the output and the input is -45° at this frequency. Precisely this cut-off frequency is called the bandwidth of a control loop.

Setpoint and disturbance behavior of a control loop

In this chapter you can read about:

Demand behavior 186
 Disturbance behavior 186
 Test functions 187
 Characteristics of a control loop setpoint response 187

The setpoint behavior is the behavior of the control loop for the setpoint variable W . We assume that the disturbance variable $Z=0$.

The disturbance behavior describes the behavior of the control loop for disturbance variable Z . In this case, we assume, in analogy to the setpoint behavior, that the setpoint variable $W=0$.

Demand behavior

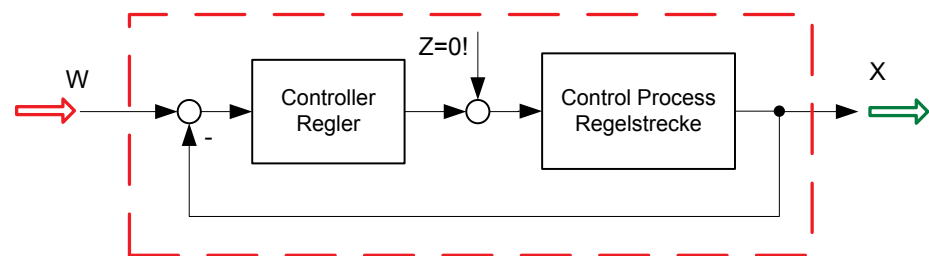

W: Setpoint value
 X: Actual value
 Z: Disturbance variable

Disturbance behavior

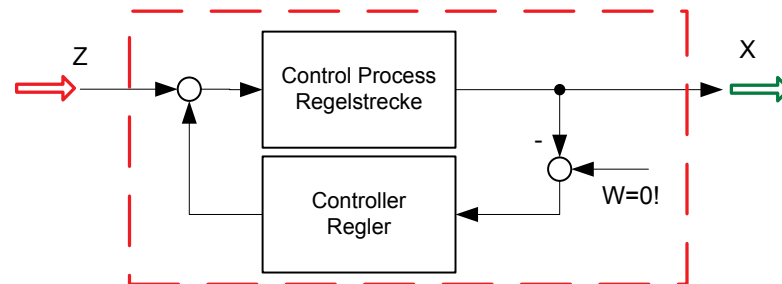

W: Setpoint value
 X: Actual value
 Z: Disturbance variable

In order to examine the disturbance and setpoint behavior, the Compax3 setup software offers 4 jerk functions.

Test functions

Test functions for the analysis of disturbance and setpoint behavior of the control loops

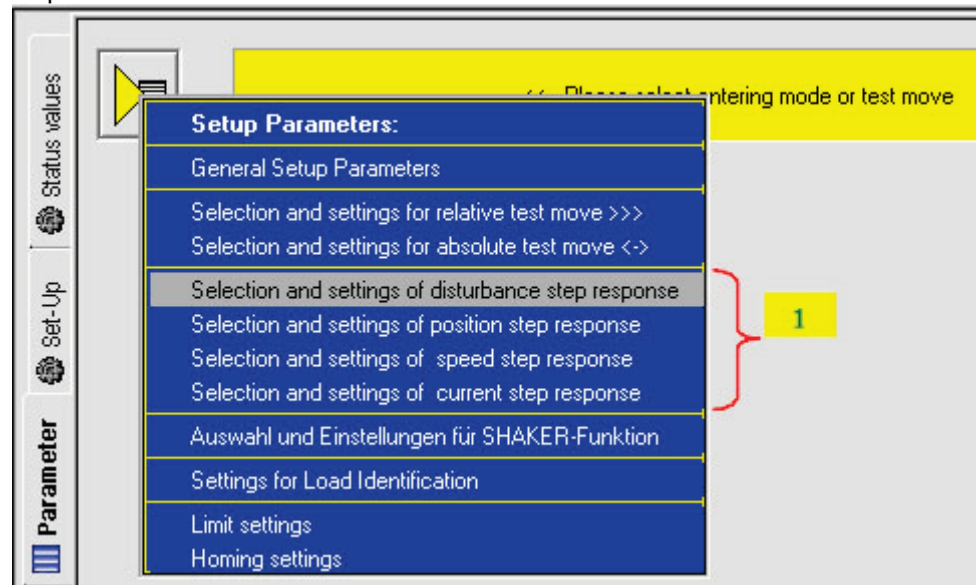

1: 4 jerk functions

The properties of the setpoint behavior of the velocity controller can be acquired from the velocity jerk response.

Characteristics of a control loop setpoint response

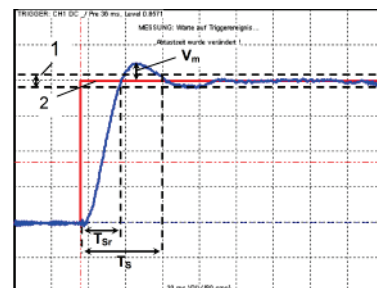

T_{sr} :	Response time. (Time elapsing until the control variable reaches one of the $\pm 5\%$ tolerance limits for the first time)
T_s :	Settling time. (Time elapsing until the control variable ultimately enters the $\pm 5\%$ range)
V_m :	maximum overshoot width
1	Tolerance range $\pm 5\%$
2	Setpoint value

Response

The response of the controller is the behavior of the actual value with respect to the calculated profile of the setpoint generator. The kinematic status variables, speed, acceleration and jerk are fed into the cascade as feedforward signals. The feedforward signals work with calculated factors and contribute to an improved contour constancy due to the minimization of the following error.

Compax3 servo controller structure

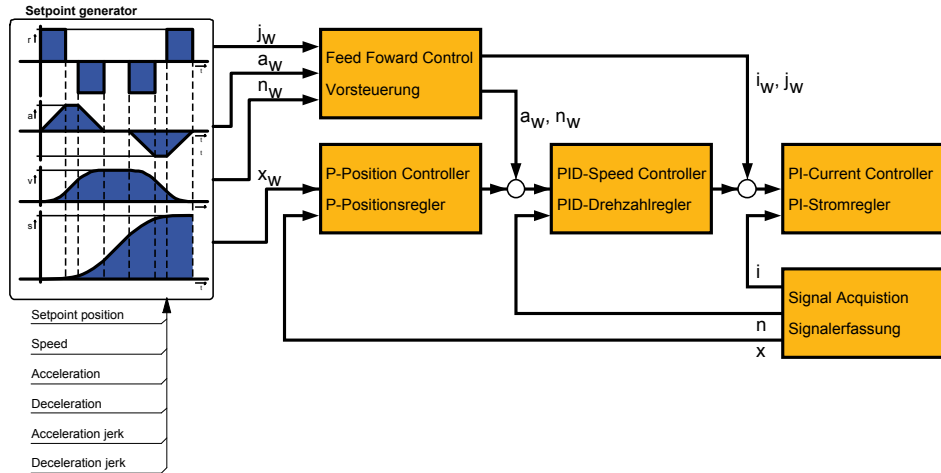

- x: Position actual value
- x_w: Setpoint position value
- a_w: Acceleration setpoint value
- n: Actual (rotational) speed
- n_w: Velocity setpoint value
- i: Actual current value
- j_w: Jerk setpoint value

Limitation behavior

Each control variable is limited by the control (actuating) element. If the control variable demanded by the controller is within the linear range (without limitation), the control loop shows the behavior defined by the design. If the controller demands however a higher control variable than permitted by the limitation, the control variable is limited and the controller slows down.

Hint You should therefore make sure that the control variable (output) of the controller does not remain within the limitation or only for a very short time.

Cascade control

In this chapter you can read about:

Structure of a cascade control 188
 Cascade structure of Compax3..... 189

In drive technology, a cascading structure with several controllers (normally 3) is often used. This improves the control behavior. For this, additional sensors must be fixed within the control path. You will get the structure of a cascade control.

Structure of a cascade control

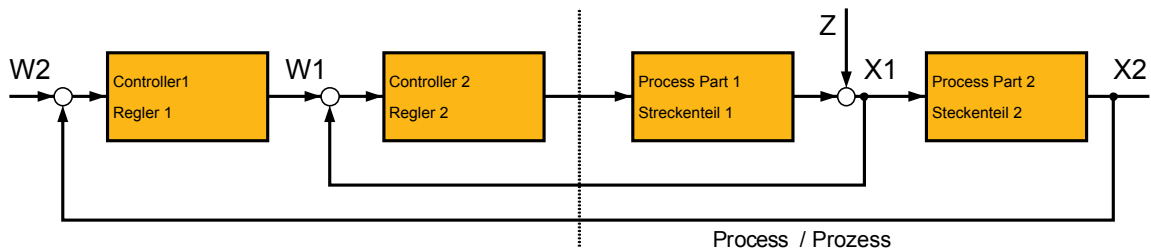

- W1 Setpoint value (setpoint) for the superposed controller 2
- W2 Setpoint value (setpoint) for the subordinate controller 1
- X2: Actual variable (actual value) for controller 2
- X1: Actual variable (actual value) for controller 1

The cascade control offers the following advantages:

- ◆ Disturbances occurring within the control path, can be compensated in the subordinate control loop. Therefore they must not pass through the entire control path and are thus compensated earlier.
- ◆ The delay times within the path can be reduced for the superposed controller.
- ◆ The limitation of the intermediate variables can be made by the control variable limitation of the superposed controller rather easily.
- ◆ The effects of the non-linearity for the superposed controllers can be reduced by the subordinate control loops.

In the Compax3 servo drive, a triple cascade control is implemented with the following controllers - position controller, velocity controller and current controller.

Cascade structure of Compax3

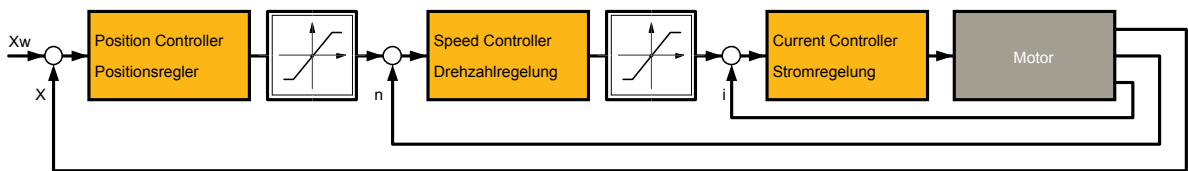

Rigidity

In this chapter you can read about:

Static stiffness	189
Dynamic stiffness	189
Correlation between the terms introduced.....	191

The stiffness of a drive represents an important characteristic. The faster the disturbance variable can be compensated in the velocity control path and the smaller the oscillation caused, the higher the stiffness of the drive. With regard to stiffness, we distinguish static and dynamic stiffness.

Static stiffness

The static stiffness of a direct drive is comparable with the spring rate D of a mechanical spring, and indicates the excursion of the spring in the event of a constant interference force. It is the ratio between the constant force FDmax of the motor and a position difference. Due to the I term in the velocity controller, the static stiffness is therefore infinitely high in theory, as the I term is integrated until the control difference vanishes. In a digital control the static stiffness is above all limited by the finite resolution of the position signal (the error must be at least one quantization step, so that it can be detected by the reading system) and by numerical resolution. Additional effects are for instance mechanical stiffness of the mechanic components in the control path (e.g. load connection, guiding system) as well as measurement errors of the measurement system.

Dynamic stiffness

In this chapter you can read about:

Traditional generation of a disturbance torque/force jerk.....	190
Electronic simulation of a disturbance torque jerk with the disturbance current jerk.....	190
Disturbance jerk response	190

The dynamic stiffness is described by the ratio between the change in load torque or in load force and the resulting position deviation (following error):

$$\frac{-\Delta M_L}{\Delta x}$$

The higher this ratio (=dynamic stiffness), the higher the necessary change is load torque in order to generate a defined following error.
 The dynamic stiffness can be acquired from the disturbance jerk response.

Traditional generation of a disturbance torque/force jerk

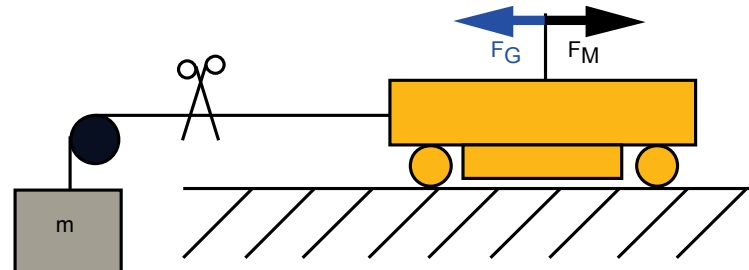

In settled state of the control, the motor force F_M corresponds exactly to the load force $F_G = m \times g$.
 If the cord is cut through, the load force is eliminated abruptly and the controller must first of all settle to the new situation.

In order to simulate this load jerk electronically, a disturbance current jerk is fed to the Compax3 as a variable proportional to the disturbance torque at the velocity controller output.

Electronic simulation of a disturbance torque jerk with the disturbance current jerk

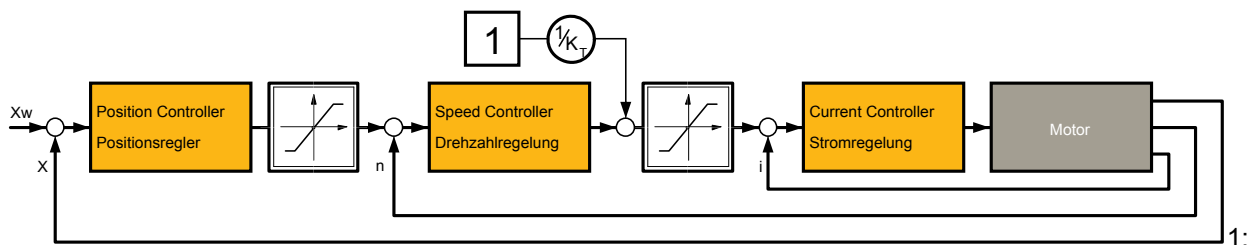

Feeding in of a disturbance current jerk, which corresponds to a disturbance torque jerk.
 The maximum amplitude and the settling time of the following error decline with rising dynamic stiffness. The settling behavior of the following error is furthermore a measure for the attenuation and the bandwidth of the control.

Disturbance jerk response

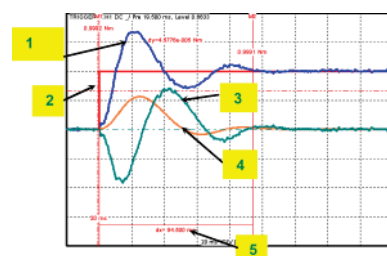

- 1: Compensation torque of the controller
- 2: Simulated disturbance torque
- 3: Actual speed
- 4: Following error
- 5: Settling Time

Correlation between the terms introduced

The introduced terms:

- ◆ Stability
- ◆ Damping
- ◆ Velocity
- ◆ Bandwidth
- ◆ Setpoint and disturbance behavior
- ◆ Control variable limitation
- ◆ Replacement time constant
- ◆ Rigidity

are related as follows:

- ◆ A well-attenuated control features a stable control behavior.
- ◆ The velocity of a control loop is a measure for the reaction rate of the controller to the disturbance variable (disturbance behavior) as well as to the setpoint variable (setpoint behavior).
- ◆ The faster the control, the higher its bandwidth.
- ◆ The term replacement time constant is an approximation and is only valid in a defined scope¹. In this scope, the control is always stable and well-attenuated.
- ◆ If the controller does not work in the linear range, but the control variable of the controller is within the limitation, the control slows down and the control difference rises.
- ◆ The stiffness represents the bandwidth of the velocity control. The higher the stiffness value of the velocity control, the higher the bandwidth of the velocity controller and the stiffer the drive.

Automated controller design

In this chapter you can read about:

Step response of the velocity loop depending on the optimization parameter "attenuation" and "stiffness"..... 192

The controller design takes place after the configuration immediately before the configuration download into the device. The controller coefficients are preassigned according to the design method of cross-ratios so that a stable control is achieved. The automatic, robust controller design calculates the P and I terms of the individual controllers (current, velocity, position) on the basis of the configured motor and application parameters.

Please observe: Faulty motor and application parameters may lead under certain circumstances to instable controllers.

The controller parameters are not directly available for the optimization. Instead, they can be changed with the aid of the following optimization parameters:

- | | |
|--|--------------------------------------|
| Optimization of the current controller dynamics: | ◆ Current loop bandwidth in % |
| Optimization of the velocity loop dynamics: | ◆ "Attenuation of current loop" in % |
| | ◆ "Stiffness" in % |
| | ◆ "Attenuation" in % |
| | ◆ Velocity loop - "D" term in % |

The bandwidth parameter states the actually effective % of the calculated default velocity. The default bandwidth of the current controller is fixed to approx. fGR=531Hz. In reverse this signifies that each motor delivers the same step response. The prerequisite is, of course, that you keep out of the control signal limitation (voltage limitation). The attenuation characterizes the controller's tendency to oscillate with respect to an excitation signal (see below). The stiffness (of the velocity loop, corresponds to the bandwidth of the current loop) describes the velocity of the velocity loop (see below).

Step response of the velocity loop depending on the optimization parameter "attenuation" and "stiffness"

Attenuation = 100%

Stiffness = 100%

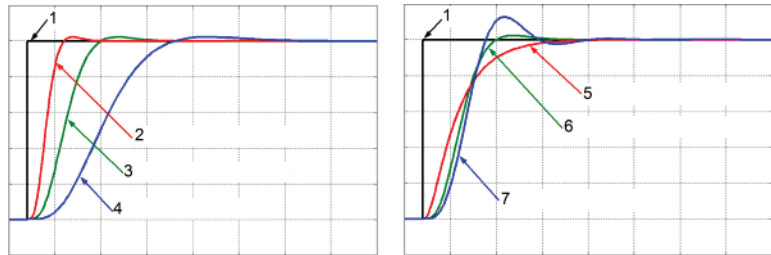

- 1: Setpoint value
- 2: Actual value (stiffness = 200%)
- 3: Actual value (stiffness = 100%)
- 4: Actual value (stiffness = 50%)
- 5: Actual value (attenuation = 500%)
- 6: Actual value (attenuation = 100%)
- 7: Actual value (attenuation = 50%)

The D-term parameter (of the velocity loop) activates existing control oscillations of drives with elastic coupling (e.g. toothed belt drives). The D-term is not automatically designed and must therefore be set manually.
 The position controller is automatically adapted depending on the stiffness of the velocity loop.

Controller coefficients

In this chapter you can read about:

Velocity Loop P Term 192
 D-term of the KD velocity controller 193
 P-term KV position loop 193

Dependence of the controller coefficients from the optimization objects

The controller coefficients are influenced by the optimization objects such as "stiffness" and/or "attenuation". The dependency is displayed below.

I-term KI in the velocity loop

$$K_I = \frac{St[\%]}{100 \cdot T_{EGD}}$$

$$\Rightarrow K_I \sim St$$

- T_{EGD}: The replacement time constant of the closed velocity loop.
- St R Rigidity

Velocity Loop P Term

$$K_{PV} = \frac{St[\%]}{100 \cdot T_{EGD}} \cdot \frac{Tm[\%]}{100} \cdot T_N \cdot \frac{100}{EMK[\%]} \cdot \frac{30 + 0,14 \cdot Dp[\%]}{20}$$

$$\Rightarrow K_{PV} \sim St \wedge K_{PV} \sim Tm / EMK \wedge K_{PV} = f_{LIN}(Dp)$$

- T_{EGD}: The replacement time constant of the closed velocity loop.
- T_N: The mechanical integration time constant of the motor.
- f_{LIN}(): Linear function (straight) between attenuation and KPv
- Tm Moment of Inertia
- St Rigidity
- Dp Damping

D-term of the KD velocity controller

$$K_D = \frac{Dterm[\%]}{100} \cdot K_{D_100\%}$$

$$\Rightarrow K_D \sim Dterm$$

KD_100% The defined 100% coefficient

:

Dterm D term

P-term KV position loop

$$K_V = \frac{St[\%]}{100 \cdot T_{EGD}} \cdot \frac{20}{30 + 0,14 \cdot Dp[\%]} \cdot T_X$$

$$\Rightarrow K_V \sim St[\%] \wedge K_V = f_{LIN}(1/Dp[\%])$$

T_{EGD}: The replacement time constant of the closed velocity loop.

T_X: The position integration time constant of the motor.

St Rigidity

Dp Damping

f_{LIN}(): Linear function (straight) between 1/attenuation and KV

4.4.3.4 Setup and optimization of the control

For the setup and optimization of the control loops, the optimization window is available.

The Compax3 control functionality is divided into 2 sections, standard and advanced; the advanced functionality does however incorporate the entire standard functionality. The switching can be made in the optimization window.

Switching between standard and advanced

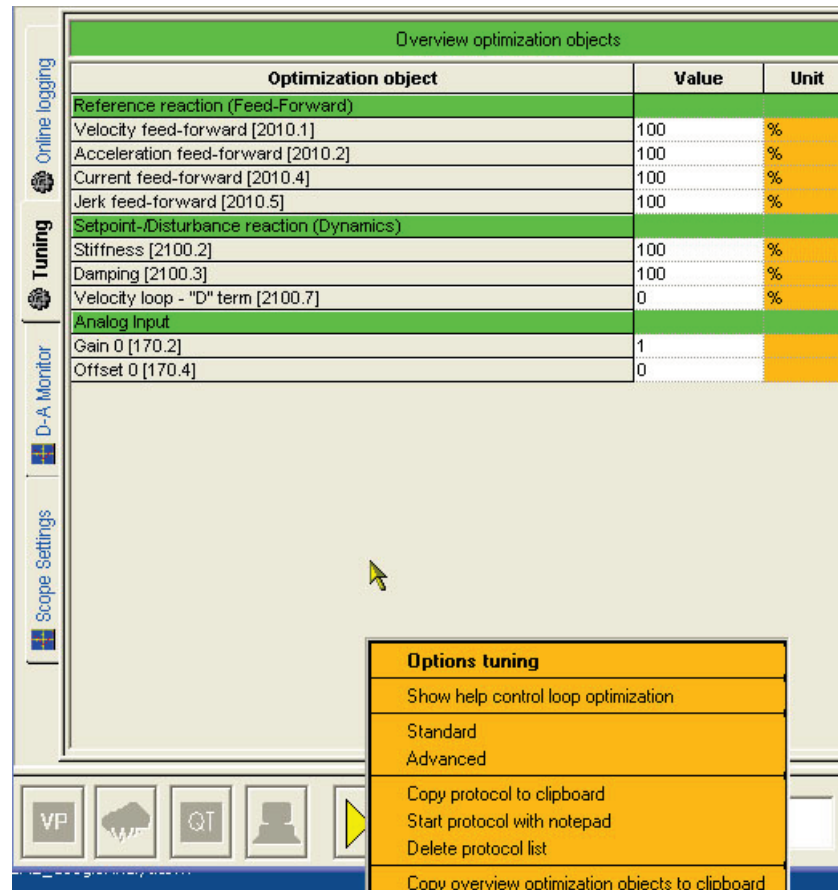

Note: The listed objects are not up to date!

In this chapter you can read about:

Standard.....	194
Advanced	200
Commissioning window	215
Proceeding during controller optimization	217

Standard

In this chapter you can read about:

Standard cascade structure.....	195
Standard optimization parameters	196
Control signal limitations.....	196
Feedforward channels	198
Control signal filter / filter of actual acceleration value.....	200

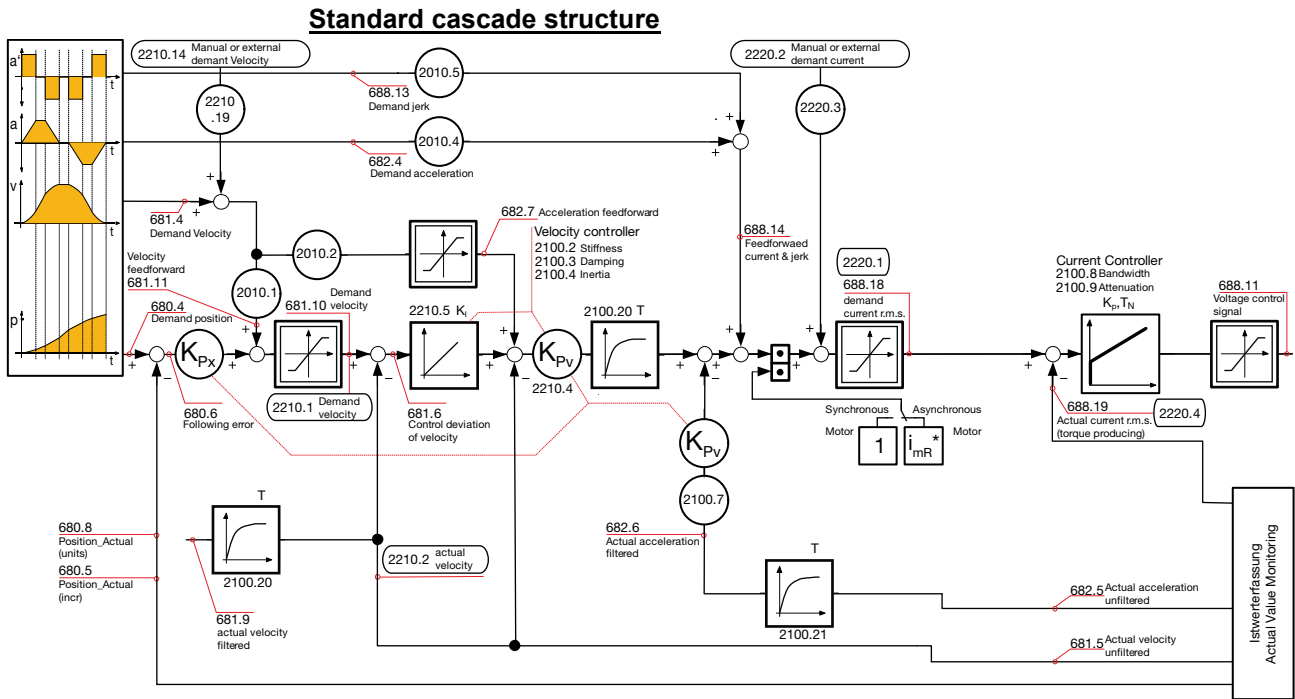

Description of the objects (see on page 295)

The framed objects are coupling objects for Compax3 - Compax3 coupling via HEDA.

Please note that the corresponding controller components must be deactivated for the coupling:

When coupling the velocity (O2219.14): O100.1 or O100.2=1063 (see object description)

When coupling via current (O2220.2): O100.1 or O100.2=1031 (see object description)

O100.1 is only copied into O100.2 upon activation of the controller, the controller can be influenced in active state with the aid of O100.2.



WARNING Changing objects O100.1 and O100.2 may cause the control to be deactivated! Protect dangerous areas!

External command value

During external setpoint specification, please respect the structure images for electronic cams or gearboxes for **signal filtering with external setpoint specification** (see on page 224) !

Complementary structure for **load control** (see on page 155).

Compax3 **controller structures** (see on page 195, see on page 200, see on page 202).

Symbol	Description
	Proportional term signal is multiplied with K_p
	First order delay component (P-T1 term)
	Integration block (I-block)
	PI-block
	Limitation block (signal limitation)
	Notch filter (band elimination filter)
	Addition block
blue description	Optimization objects (simple pointer line)
red description	Status objects (pointer line with vertical stroke)

Standard optimization parameters

Overview optimization objects		
Optimization object	Value	Unit
Reference reaction (Feed-Forward)		
Velocity feed-forward [2010.1]	100	%
Acceleration feed-forward [2010.2]	100	%
Current feed-forward [2010.4]	100	%
Jerk feed-forward [2010.5]	100	%
Setpoint-Disturbance reaction (Dynamics)		
Stiffness [2100.2]	100	%
Damping [2100.3]	100	%
Velocity loop - "D" term [2100.7]	0	%
Analog Input		
Gain 0 [170.2]	1	
Offset 0 [170.4]	0	

The above figure shows the parameters for the standard group. With the aid of these parameters, you can optimize the standard cascade structure.

Control signal limitations

In this chapter you can read about:

- Limitation of the setpoint velocity 197
- Limitation of the setpoint current 197
- Limitation of the control voltage 198

The cascade structure shows that a limitation block is available in the control signal sector of each controller. The limitations of the position and velocity loops are calculated from the set limitations in the configuration and the motor parameters of the selected motor.

Limitation of the setpoint velocity

Limitation of the setpoint velocity in the control signal sector of the position loop:
This limitation value is calculated from the maximum mechanical velocity of the motor and the set value in the configuration in % of the nominal velocity. The smaller of the two values is used for the limitation.

Example

MotorManager

maximum mechanical velocity of the motor:	$n_{\max}=3100\text{rpm}$
Rated speed of the motor:	$n_N=2500\text{rpm}$

C3 ServoManager

Max. Operating velocity:	$n_{\text{bmax}}=200\%$ of n_N $\Rightarrow 5000\text{rpm}$
--------------------------	--

Velocity limitation value = $MIN(n_{\max}, n_{\text{bmax}} * n_N / 100) =$	3100rpm
--	------------------------------------

Limitation of the setpoint current

Limitation of the setpoint current in the control signal sector of the velocity loop:
This limitation value is calculated from the device peak current, the pulse current of the motor and the set value in the configuration in % of the nominal current. The smaller of the three values is used for the current limitation.

Example

Device

C3 S063 V2 F10 T30 M00 device peak current:	$I_{G\max}=12.6A_{\text{rms}}$
---	--------------------------------

MotorManager

Rated current of the motor:	$I_N=5.5A_{\text{rms}}$
Peak Current:	$I_{\text{imp}}=300\%$ I_N $\Rightarrow 16.5A_{\text{rms}}$

C3 ServoManager

Current (Torque) Limit:	$I_{\text{bmax}}=200\%$ of I_N $\Rightarrow 11A_{\text{rms}}$
-------------------------	--

Current limitation value = $MIN(I_{G\max}, I_{\text{imp}} * I_N / 100, I_{\text{bmax}} * I_N / 100) =$	$11A_{\text{rms}}$
--	--------------------------------------

Limitation of the control voltage

Limitation of the control voltage in the control signal sector of the current loop:
 This limitation is fixed and cannot be influenced by the user. The limitation value depends on the DC voltage of the device.

Please note! In the event of highly dynamic motion cycles it is necessary to make sure not to enter the control signal limitation (or, if so only for a very short time) as the drive is then not in the position to follow the set dynamics due to the slow drive physics and the limited control signal range.

Feedforward channels

In this chapter you can read about:

Influence of the feedforward measures 198
 Motion cycle without feedforward control 199
 Motion cycle with feedforward measures 199

The feedforward channels are used for the specific influence of the guiding behavior of a control. The calculated and evaluated status variables are coupled into the corresponding places within the controller cascade. In practice, the feedforward control offers the following advantages:

- ◆ Minimal following error
- ◆ Improves the transient response
- ◆ Gives greater dynamic range with lower maximum current

The Compax3 servo drive disposes of four feedforward measures (see in the standard cascade structure):

- ◆ Velocity Feed Forward
- ◆ Acceleration feed-forward
- ◆ Current feed-forward
- ◆ Jerk feed-forward

The above order represents at the same time the effectiveness of the individual feedforward measures. The influence of the jerk feedforward may be, depending on the profile and the motor, negligibly small.

Please note! But the principle of feedforward control fails in limiting the motor current or the motor speed during the acceleration phase!

Influence of the feedforward measures

Following error minimization by feedforward control / course of the setpoint generator signals

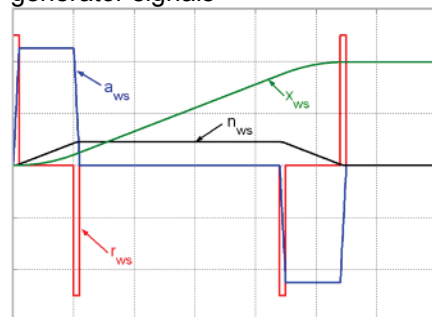

- xws: Position setpoint value of the setpoint generator
- vws: Velocity setpoint - setpoint generator
- aws: Acceleration setpoint value setpoint generator
- rws: Jerk setpoint value setpoint generator

Motion cycle without feedforward control

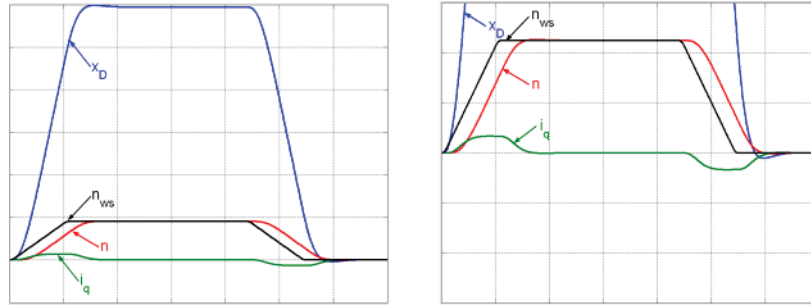

Motion cycle with feedforward measures

Velocity feedforward

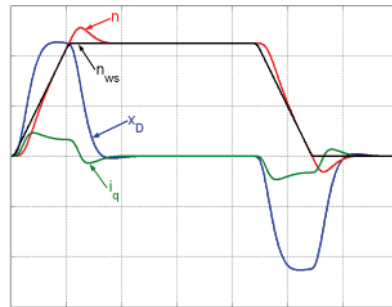

Velocity and acceleration feedforward

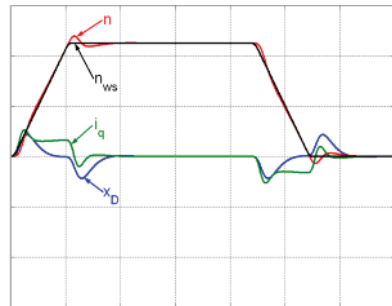

Velocity, acceleration and current feedforward

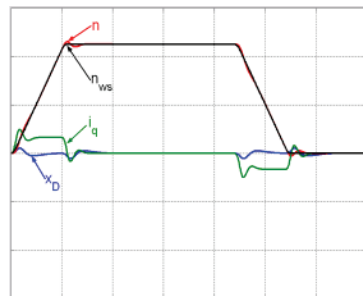

Velocity, acceleration, current and jerk feedforward

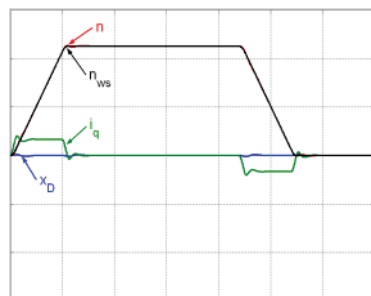

Control signal filter / filter of actual acceleration value

The filters in the Compax3 firmware are implemented as P-T1 filters (first order deceleration component see chapter 0 (see on page 224, see on page 225).) The two "control signal filter (velocity loop)" (Object 2100.20) and "acceleration value filter" (Object 2100.21) are set in μs . The value range for these filters is 63... 8 300 000 μs . Depending on the replacement time constant of the closed velocity loop, we can make recommendations for the setting.

Setting recommendation for "control signal filter (velocity loop)":

- $O2100.20 \leq O2210.17[\mu\text{s}] / 5$ for $O2210.17 \geq 10\ 000\mu\text{s}$
- $O2100.20 \leq O2210.17[\mu\text{s}] / 3 - 1333\mu\text{s}$ for $4000\mu\text{s} \leq O2210.17 < 10\ 000\mu\text{s}$
- $O2210.20 = 0$ for $O2210.17 < 4000\mu\text{s}$
- $O2210.17$: Object replacement time constant of the velocity loop in μs .
- $O2100.20$: Object control signal filter (velocity loop) in μs .

Please note! It cannot be excluded that the filter may have a destabilizing effect even though set according to the above recommendation. In this case the filter time constant must be reduced.

Advanced

In this chapter you can read about:

- Extended cascade (structure variant 1).....200
- Extended cascade structure (structure variant 2 with disturbance variable observer).....202
- Optimization parameter Advanced.....203
- EMC feedforward.....204
- Motor parameters.....204
- Filter "External Command Interface".....204
- Voltage decoupling.....204
- Load control.....204
- Luenberg observer.....204
- Commutation settings of the automatic commutation.....207
- Notch filter.....211
- Saturation behavior.....213
- Control measures for drives involving friction.....214

Extended cascade (structure variant 1)

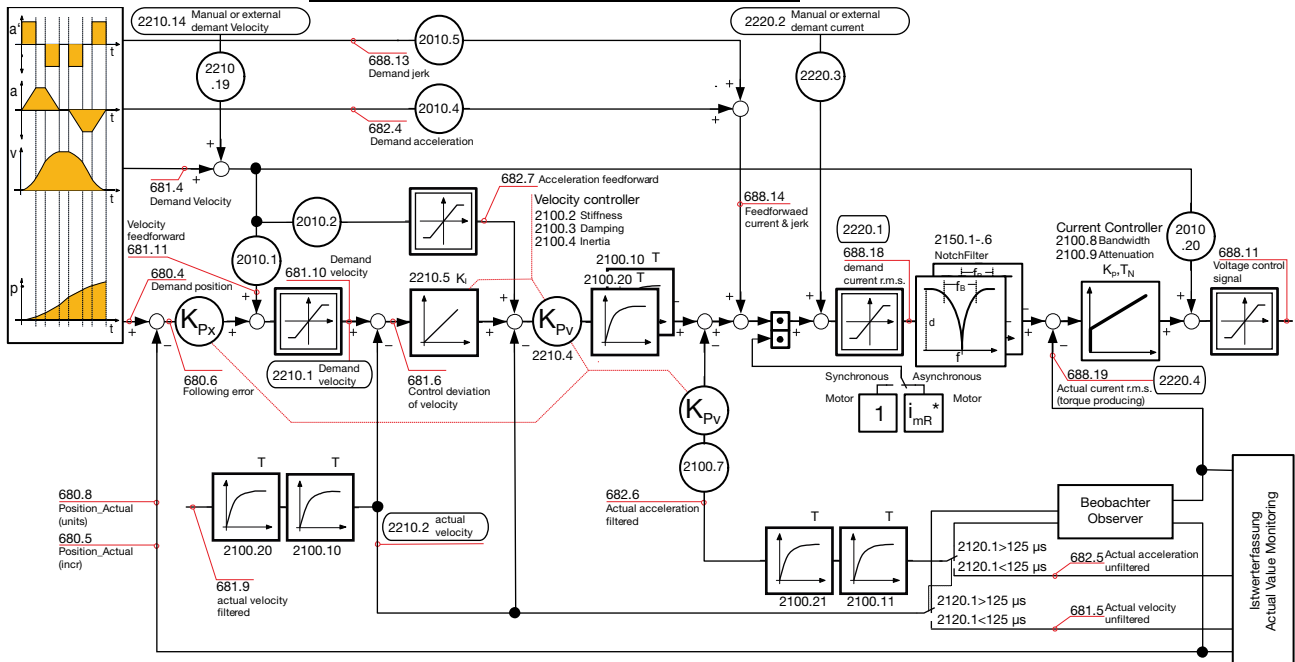

Description of the objects (see on page 295)

The framed objects are coupling objects for Compax3 - Compax3 coupling via HEDA.

Please note that the corresponding controller components must be deactivated for the coupling:

When coupling the velocity (O2219.14): O100.1 or O100.2=1063 (see object description)

When coupling via current (O2220.2): O100.1 or O100.2=1031 (see object description)

O100.1 is only copied into O100.2 upon activation of the controller, the controller can be influenced in active state with the aid of O100.2.

⚠ WARNING







Changing objects O100.1 and O100.2 may cause the control to be deactivated! Protect dangerous areas!

External command value

During external setpoint specification, please respect the structure images for electronic cams or gearboxes for **signal filtering with external setpoint specification** (see on page 224) !

Complementary structure for **load control** (see on page 155).

Compax3 **controller structures** (see on page 195, see on page 200, see on page 202).

Symbol	Description
	Proportional term signal is multiplied with K_p
	First order delay component (P-T1 term)
	Integration block (I-block)
	PI-block
	Limitation block (signal limitation)
	Notch filter (band elimination filter)
○	Addition block
blue description	Optimization objects (simple pointer line)
red description	Status objects (pointer line with vertical stroke)

Extended cascade structure (structure variant 2 with disturbance variable observer)

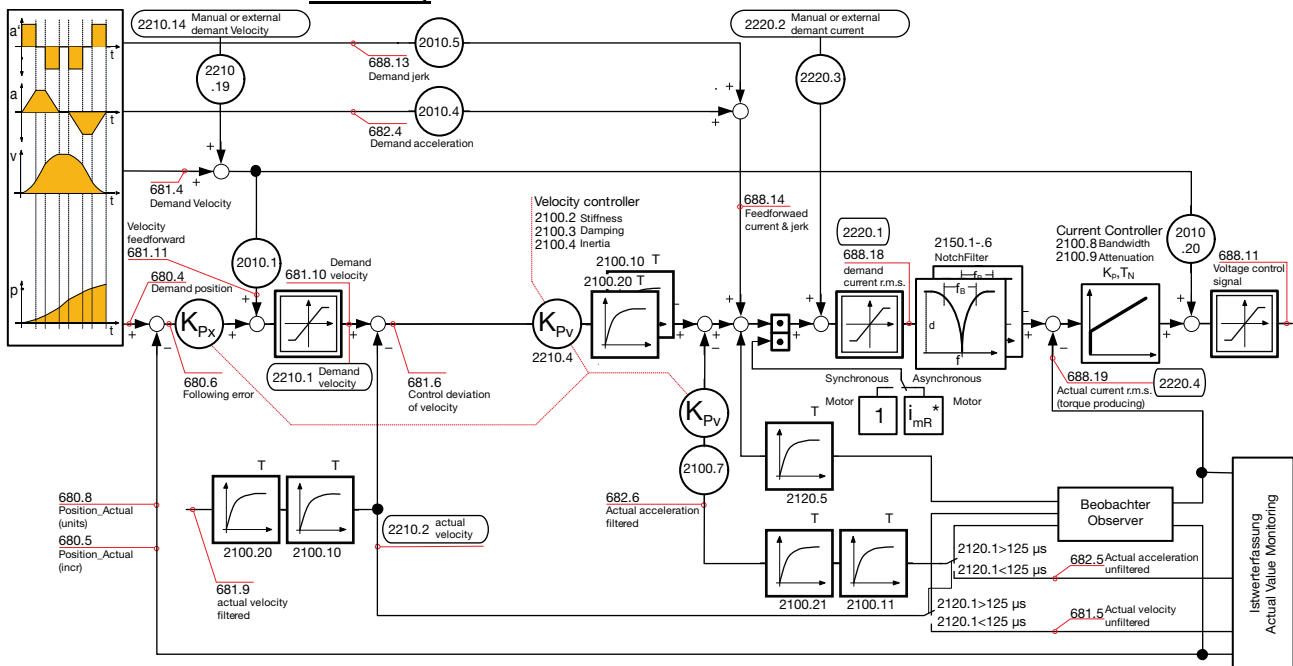

Description of the objects (see on page 295)

The framed objects are coupling objects for Compax3 - Compax3 coupling via HEDA.

Please note that the corresponding controller components must be deactivated for the coupling:

When coupling the velocity (O2219.14): O100.1 or O100.2=1063 (see object description)

When coupling via current (O2220.2): O100.1 or O100.2=1031 (see object description)

O100.1 is only copied into O100.2 upon activation of the controller, the controller can be influenced in active state with the aid of O100.2.



WARNING Changing objects O100.1 and O100.2 may cause the control to be deactivated! Protect dangerous areas!

External command value

During external setpoint specification, please respect the structure images for electronic cams or gearboxes for **signal filtering with external setpoint specification** (see on page 224) !

Complementary structure for **load control** (see on page 155).

Compax3 **controller structures** (see on page 195, see on page 200, see on page 202).

Symbol	Description
	Proportional term signal is multiplied with K_p
	First order delay component (P-T1 term)
	Integration block (I-block)
	PI-block
	Limitation block (signal limitation)
	Notch filter (band elimination filter)
	Addition block
blue description	Optimization objects (simple pointer line)
red description	Status objects (pointer line with vertical stroke)

Optimization parameter Advanced

Overview optimization objects		
Optimization object	Value	Unit
Reference reaction (Feed-Forward)		
Velocity feed-forward [2010.1]	100	%
Acceleration feed-forward [2010.2]	100	%
Current feed-forward [2010.4]	100	%
Jerk feed-forward [2010.5]	100	%
Setpoint-Disturbance reaction (Dynamics)		
Stiffness [2100.2]	100	%
Damping [2100.3]	100	%
Moment of Inertia [2100.4]	100	%
Velocity loop - "D" term [2100.7]	0	%
Filter - Actual velocity [2100.5]	100	%
Filter 2 - actuating signal (velocity controller) [2100.10]	0	us
Filter - Actual acceleration [2100.6]	0	%
Filter 2 - Actual acceleration [2100.11]	0	us
Current loop - Bandwidth [2100.8]	50	%
Current loop - Damping [2100.9]	100	%
Observer		
Time Constant [2120.1]	0	us
Filter - Observed disturbance [2120.5]	1000	us
Enable Disturbance Compensation [2120.7]	0	
Position Control		
Position Loop - K _V factor [2200.3]	100	%
Filter external input setpoints		
Filter - Ext. velocity feed-forward [2011.1]	500	%
Filter - Ext. accel. feed-forward [2011.2]	500	%
Filter - Ext. jerk feed-forward [2011.3]	500	%
Filter external signal source		
Filter - Ext. velocity feed-forward [2011.1]	500	%
Filter - Ext. accel. feed-forward [2011.2]	500	%
Trackingfilter HEDA [2109.1]	0	500us
Filter setpoints		
Trackingfilter [2110.1]	1	500us
Filter velocity [2110.3]	0	%
Filter acceleration [2110.4]	0	%
Analog Input		
Gain 0 [170.2]	1	
Offset 0 [170.4]	0	
Gain 1 [171.2]	1	
Offset 1 [171.4]	0	

Current controller

The current controller works with a P component in the feedback; this results in very low overshoot.

With the aid of object 2220.27 (Bit 0 = "1"), it is possible to switch to P component in the forward path.

EMC feedforward

The EMC feedforward compensates the electromagnetically generated back e.m.f. of the motor U_{EMC} . This signal is proportional to velocity and is deduced from the setpoint velocity of the setpoint generator.

Motor parameters

Furthermore you can re-optimize the motor parameters inductance, resistance and EMC (or Kt) in the advanced mode. The LdLqRatio parameter is the ratio of the smallest and the highest inductance value of the winding, measured during one motor revolution.

Filter "External Command Interface"

Signal filtering with external command value (see on page 224, see on page 225)

Voltage decoupling

In the current control path there is a velocity and current proportional voltage disturbance variable, which must be compensated by the current loop. Due to limited controller dynamics, this disturbance variable can not always be entirely compensated by the current loop. The influence of this disturbance variable may however be minimized by activating the voltage decoupling.

Load control

If a second position feedback is available for the acquisition of the load position, the load control can be activated.

For more detailed information on the load control see device help for T30/T40 devices in the setup chapter Compax3\\load control.

Luenberg observer**In this chapter you can read about:**

Introduction observer	204
Signal flow chart Luenberg observer	205

Introduction observer

A high signal quality of the actual signal value is of high significance in the control of the motor velocity n or the motor speed v . By means of oversampling and transmitter error compensation, a high-quality position signal can be produced for speed determination. As a rule the motor speed is determined by numeric differentiation of the motor position. In this case the quantization noise Q_{vD} of the digital speed signal depends on the quantisation Q_x of the position signal and the sampling time T_{AR} of the digital control loop:

Quantization speed signal Q_{vD}

$$Q_{vD} = \frac{Q_x}{T_{AR}}$$

The quantisation of the speed signal is inversely proportional to the sampling time TAR. Hence the demands for the lowest possible sampling time and the minimum quantization noise oppose each other in the determination of speed by numeric differentiation. The noise superimposed by the digital speed signal may be reduced by the low-pass filter, however this is always at the cost of the stability margin of the digital control loop. An alternative method is to determine the speed by integration of the acceleration. The dependence of the quantisation noise QvD of the digital speed signal on the quantisation Qx of the position signal and the sampling time TAR of the digital control loop is shown by the following correlation. Quantization speed signal QvI

$$Q_{vI} = Q_a \cdot T_{AR}$$

The observer technology offers the advantage that the velocity can be calculated with the aid of integration. The idea of the observer principle is to connect a mathematical model of the control path parallel to the section observed and with the same transfer behavior. In this case, the controller also has the intermediate variables (state variables) of the control path available. However in the presence of model deviations (in structure or parameters), different signal values occur between the model and the control path. For this reason, the technique cannot be employed in this way in practice. However, the model contains the measurable output signal of the control section as a redundant quantity. By comparing the two variables, a tracking control can be used to adapt the model state variables to the state variables of the control path. As the model deviations have become minor in this case due to the simple mechanical drive train, the observer now has an efficient aid available to increase the signal quality. Increase in signal quality in the observer means that the noise components decrease, and the dynamics improve as the observed speed is feedforward-controlled undelayed by the current and is not just calculated delayed from the position signal using simple differentiation.

Signal flow chart Luenberg observer

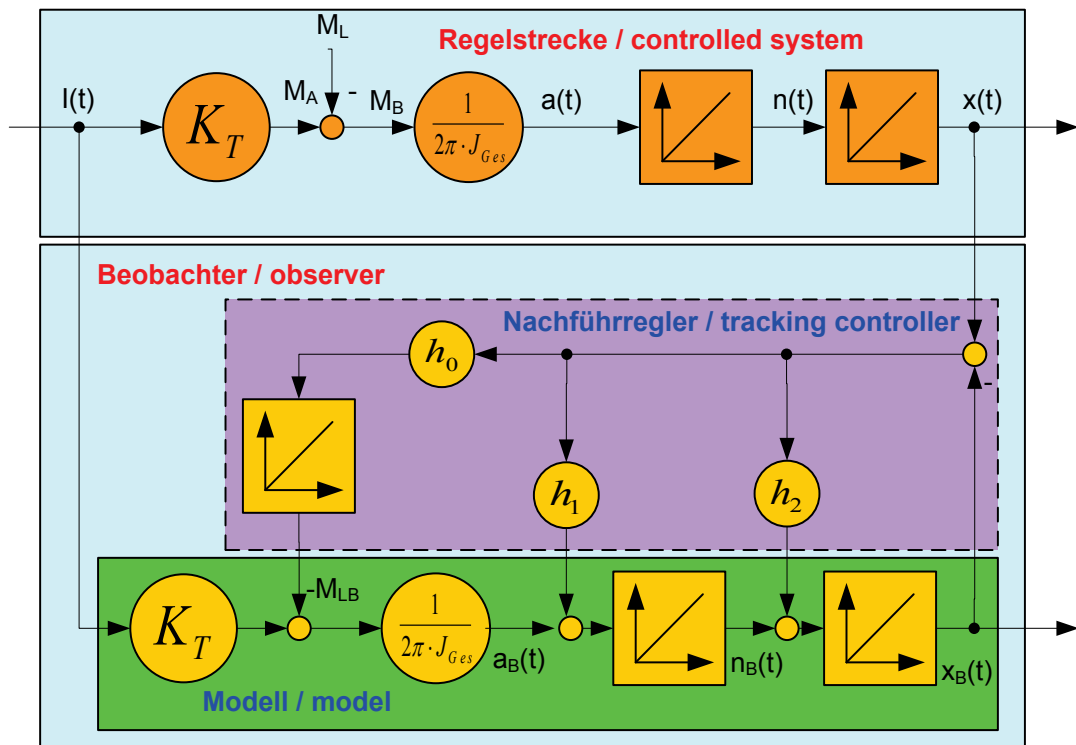

$I(t)$:	Torque-forming motor current
K_t :	Torque constant
$M_L(t)$:	External disturbance torque
J_{total} :	Total mass moment of inertia (motor + load)
$a(t)$:	Acceleration
$n(t)$:	Velocity
$x(t)$:	Position
Index b:	Observed signal quantities
$h_0 \dots h_2$:	Controller coefficients of the tracking controller

The figure shows that an additional I element is connected for interference compensation to correct external disturbance forces in the observer. Therefore the speed and the acceleration observed are statically precise. The same applies to the output of the integrator in the tracking controller which is a statically precise determination of an external interference torque M_L . For this reason, the I component is not required in the speed controller for some applications, and the entire control can be set up as a state cascade control. This increases the bandwidth of the speed and position controlled member by factor 2. For this reason this increases the interference stiffness of the drive and the following error behavior improve.

Note The use of the speed monitor with interference compensation (\Rightarrow no I-term in the speed control) needs an active position control. Without this superimposed control the axis drifts, even with a speed setpoint value of 0!

Here the quantization of the speed signal is proportional to the sampling time T_{AR} , hence there is no longer any conflict between the requirements for minimum sampling time and minimum quantization noise. For the integral velocity acquisition, the motor current variable, which is proportional to the acceleration, can be used. This approach is particularly advantageous in direct drive engineering; due to the absence of a mechanical drive train, there is a very good match between the mathematical model of the observer and the real physical control section in the fundamental frequency range of the control. This applies in particular to direct drive systems with fixed moving masses, as otherwise the mismatch between model and the physical drive system has a destabilizing influence on the transfer behavior of the speed control. A remedy is to increase the observer dynamics, however this increases the noise of the observed signals. Therefore in the case of variable moving masses a compromise has to be found between the dynamics of the observer and the maximum stiffness of the drive.

Commutation settings of the automatic commutation

In this chapter you can read about:

Display of the commutation error in incremental feedback systems207
 Prerequisites for the automatic commutation208
 Course of the automatic commutation function208
 Other211

Permanently excited synchronous motors can only be operated with an absolute feedback system (at least for electric motor rotation). The reason is the necessary commutation information (position assignment of the magnet field generated by the motor to the motor magnets). Without the commutation information, there is inevitably the possibility of a positive feedback between position and velocity loop ("running away" of the motor) or of bad motor efficiency (reduced force constant). Digital hall sensors are the most common aid to prevent this. Due to the mechanical design it is however impossible or very hard to integrate these sensors in some motors. The Compax3 automatic commutation function (in the F12 direct drive device) described below allows however to use incremental feedback systems without hall sensors.

The functionality implemented in the servo drive establishes the necessary reference between motor stator field and permanent magnetic field without additional aids.

The incremental feedback devices are, in contrast to absolute feedback devices, able to acquire relative distances. It is true that any position can be approached from a starting point, there would be however no consistency between these position values and a fixed virtual absolute system. Other than with an absolute feedback, the correlation between rotor and stator is lost if the position acquisition is switched off ("the position acquisition zero is lost"). When switching on, the actual position is randomly taken as zero. A commutation angle error can therefore absolutely not be excluded. Even a system adjusted before, would show an angular error, for example after a current failure. Therefore the angular error occurring randomly upon each new switching on must always be compensated in an incremental system.

Display of the commutation error in incremental feedback systems

$\Delta\epsilon = 0$ (adjusted)

$\Delta\epsilon \neq 0$ (not adjusted)

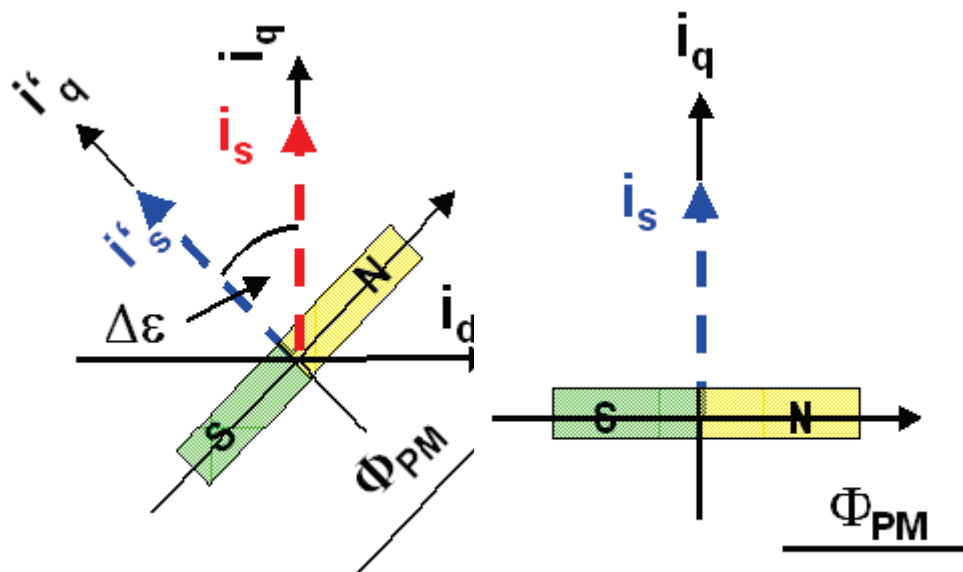

Rotor was turned in switched-off state.

- blue: ideal position
- red: unfavorable position
- PM: magnetic flux of the permanent magnets
- i_s : Current pointer
- $\Delta\varepsilon$: Commutation error
- l' : ideal position
- i_q : Quadrature current (torque forming)

The automatic commutation function (AK) in Compax3 uses the position dependent sinusoidal torque course of permanently excited AC synchronous motors. If the motor windings are energized with DC voltage for instance, the motor develops a sinusoidal torque depending on the rotor position, which can be used for example by evaluating the resulting movement in order to determine the correct motor commutation.

The automatic commutation with movement in the Compax3 has the following properties:

- ◆ The motor movement occurring during the commutation is, with correctly parameterized function, very small. It is typically in the range smaller than 10° electrical revolution ($=10^\circ/\text{motor poles physically or } 10^\circ/360^\circ \cdot \text{motor pitch for a linear motor}$).
- ◆ The precision of the acquired commutation angle depends on the external conditions, however lies normally in the range better than 5° electrical revolution.
- ◆ The time until the termination of the commutation acquisition is typically below 10s.

Prerequisites for the automatic commutation

- ◆ A movement of the motor must be permitted. The movement actually occurring depends greatly on the motor (friction conditions) itself, as well as on the load moved (inertia).
- ◆ Applications requiring a motor brake, i.e. applications where active load torques are applied at the motor (e.g. vertical actuator, slope) are not permitted.
- ◆ Due to the function principle, high static friction or load torques will deteriorate the result of automatic commutation.
- ◆ When performing automatic commutation, a motion of at least $\pm 180^\circ$ must be electrically possible (no mechanic limitation)! The implemented automatic commutation function with motion cannot be used for applications with limit or reversal switches.
- ◆ With the exception of missing commutation information, the controller/motor combination is configured and ready for operation (parameters correctly assigned for the drive/linear motor). Feedback direction and effective direction of the field of rotation must be identical (automatic commutation performed in the MotorManager).

Course of the automatic commutation function

If "automatic commutation with movement" is selected as source of commutation, the automatic commutation sequence runs once if the power stage is enabled. If the power stage is enabled or disabled afterwards, the automatic commutation will be left out. If an error occurs during the execution, the automatic commutation is aborted. A new "attempt to enable" the power stage will trigger a new automatic commutation.

Function principle of the automatic commutation with movement

The implemented method with movement is based on the sinusoidal dependence of the provided motor currents and the resulting movement on the effective commutation error. The acceleration performed by the motor (-> movement) in the event of constantly maintained current is a measure for the actual change in the commutation angle in the way that it disappears upon a change of exactly 0° and is, for other angles, the acceleration and its direction in dependence of the sign and value of the angular error (-180° .. 180°).

Acceleration torque depending on the commutation error.

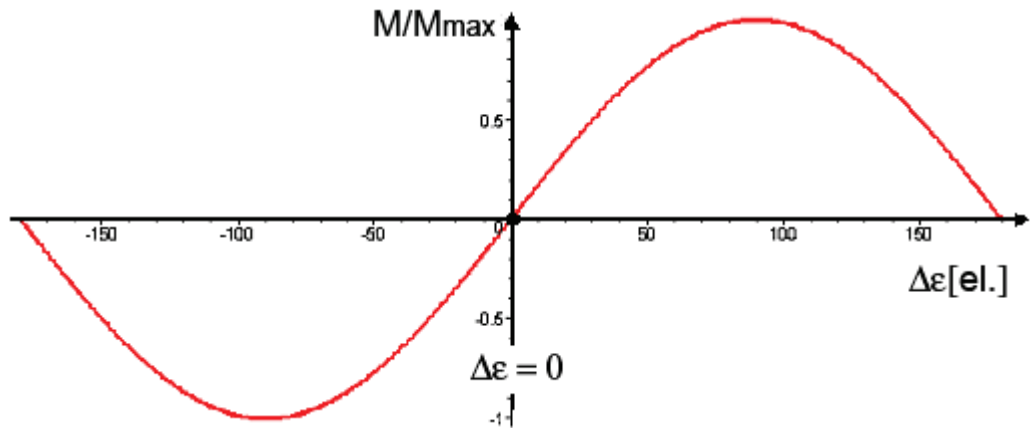

$\Delta\epsilon:$	Commutation error
$M/M_{\mu\alpha\xi}$	normalized acceleration torque

Searching for the torque maxima (phase 1)

If the sum of the actual and the estimated error angle is $\pm 90^\circ$ electrically, the motor torque is maximal for the provided current. If you gradually increase the provided motor current, the motor will, from a defined value on, surpass its friction torque and exceed a motion threshold defined by O2190.3:

Illustration of the first phase

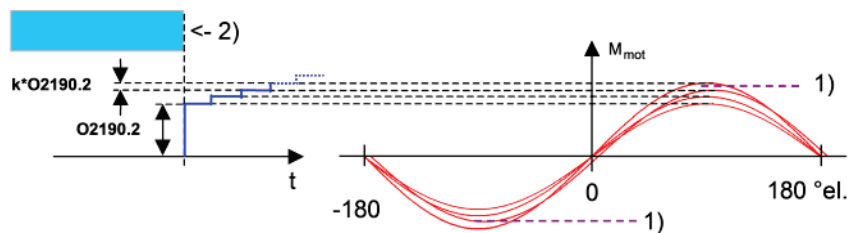

- 1): Motion threshold O2190.3
- 2): Waiting for standstill
- O2190.2: Starting current

Latching of the motor (phase 2)

Here, the drive is brought to the position with the provided motor torque=0, where the angular error is either $\pm 180^\circ$ or 0° .

Current rise in the second phase.

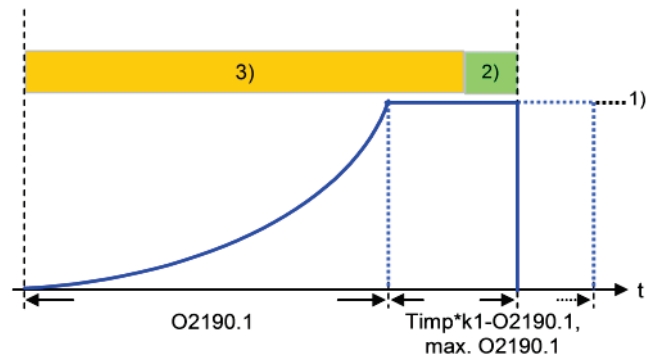

- O2190.1: Rising time of latching current
- 1) Maximum current from controller or motor
- 2) Monitoring on 5° electrical movement
- 3) Monitoring on 60° electrical movement

Motion reduction:

It is possible, to considerably reduce the motor movement occurring during the fine angle search with the aid of the "motion reduction" parameter (O2190.4). Please respect also that the acquired commutation result may be slightly worse than without this measure.

Hint As a current well above the nominal motor current is provided here, there may be saturation effects on iron core motors, which might lead to an instable current loop (-> highly frequent "creaking noises" during the automatic commutation). This can be avoided by activating the saturation characteristic line in the motor data.

Test for positive feedback (phase 3)

Here it is verified, if the motor performs a motion in the expected positive direction in the event of positive current in the torque maximum. The same motion threshold (defined via O2190.3) as in phase 1 is valid. The test is repeated several times.

A current course in ramp form is specified (target: minimum motion). The break between the tests varies with the current rise time O2191.1.

Illustration of the third phase

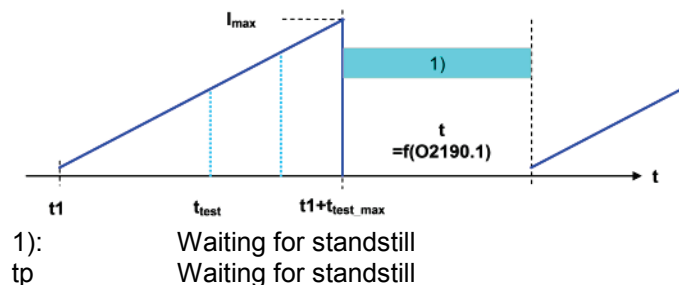

Other

- ◆ During the sequence (time according to parameterization >> 1s) the automatic commutation is externally visualized by a LED blinking code (green permanent and red blinking).
- ◆ Device errors will lead to an abort of the automatic commutation.
- ◆ During automatic commutation, no motion commands are accepted.
- ◆ The controller cascade entirely deactivated during automatic commutation, with the exception of the current loop.
- ◆ In multi-axis applications, the axes to be automatically commutated must be awaited (output of the MC_Power block must deliver "True")!
- ◆ The automatic commutation is only started if the drive is at standstill.
- ◆ After the occurring and acknowledgement of a feedback error or a configuration change of the feedback system, the automatic commutation must be performed again, as it might be that the position entrainment in the servo controller is interrupted (commutation information is lost).

Notch filter

In this chapter you can read about:

Effect of the notch filter 211
 Wrongly set notch filter 211
 Frequency response of the notch filter 212
 Parameterization by 3 objects 212

Notch filters are small-band band elimination filters which slope in a wedge form towards the center frequency. The attenuation of this center frequency is extremely high in most cases. With the aid of the notch filters it is possible to purposefully eliminate the effects of mechanical resonance frequencies. With this, the mechanical resonance point is not activated itself, but the excitation of this point of resonance is avoided by the control.

Effect of the notch filter

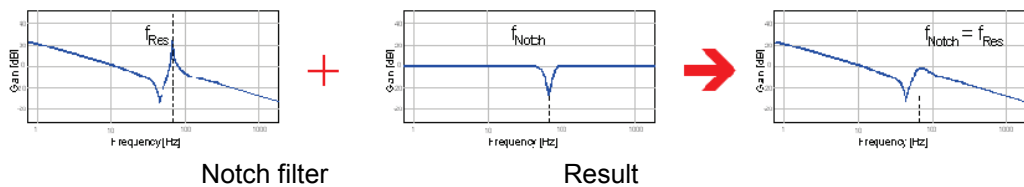

Resonance

As can be seen in the figure, the notch filter is only useful in cases where the set frequency of the notch filter is exactly the same as the disturbing frequency. The notch filter as well as the resonance point are very narrowband. If the resonance point does only minimally change (e.g. by changing the masses involved), it is not sufficiently activated by the notch filter.

Wrongly set notch filter

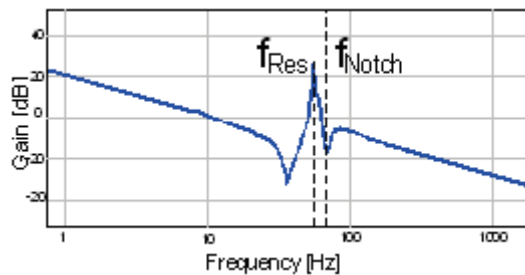

In the Compax3, two notch filters which are independent of each other are implemented.

Frequency response of the notch filter.

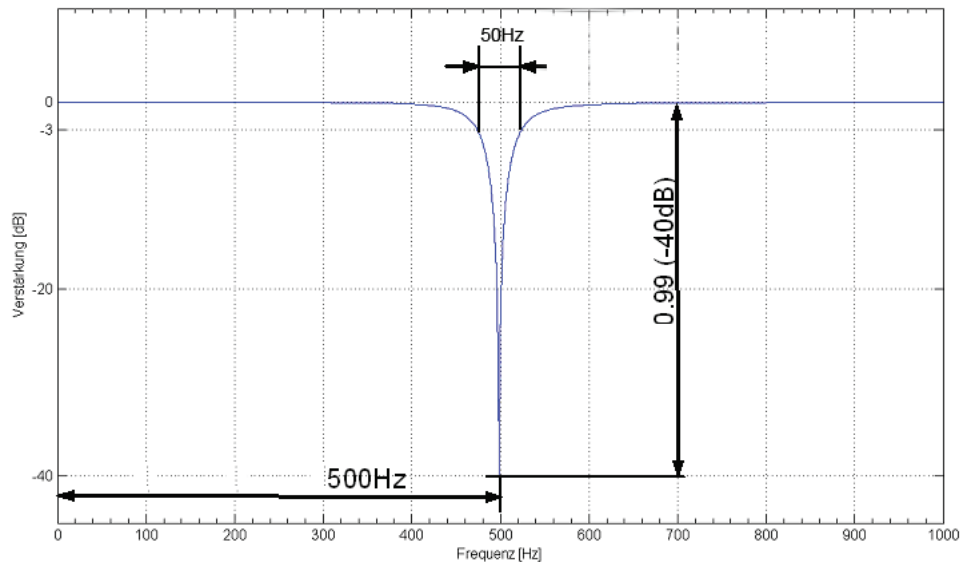

Center frequency = 500Hz

Bandwidth = 50Hz

Depth = 0.99 (-40dB)

Parameterization by 3 objects.

[In this chapter you can read about:](#)

This defines the frequency at which the notch filter attenuation is highest. In practice it shows that notch filters can only sensibly be used if the distance between the controller bandwidth (velocity loop) and the center frequency is long enough (at least factor 5). This permits to deduce the following recommendation:

$$O2150.x \geq \frac{5000000}{2\pi \cdot O2210.17[\mu s]}$$

$$x = 1 \text{ or } x = 4$$

Obj2210.17: Replacement time constant of the velocity loop in μs

Note: If this distance is too small, the stability of the control can be very negatively influenced!

This defines the width of the notch filter.

The value refers to the entire frequency band, where the attenuation of the filter is higher than (-)3dB.

In practice it shows that even if there is enough distance towards the control, it can be negatively influenced by too high bandwidths (higher than 1/4 of the center frequency).

$$O2150.x \leq \frac{O2150.1/4}{4}$$

$$x = 2 \text{ or } x = 5$$

With this the size of the attenuation of the filter must be at the position of the center frequency. One stands here for complete attenuation ($-\infty$ dB) and zero for no attenuation.

$$O2150.x = 1 - 10^{-\left(\frac{D[dB]}{20}\right)}$$

$$x = 3 \text{ or } x = 6$$

D [dB]: The desired attenuation at the center frequency in dB

Saturation behavior

In this chapter you can read about:

Current jerk response213
Current jerk response with the activated saturation characteristic line.....213
Saturation can be stated with the aid of current jerk responses at different current height.

Current jerk response

Current jerk response of a motor to 2 different currents (1Arms / 2Arms)

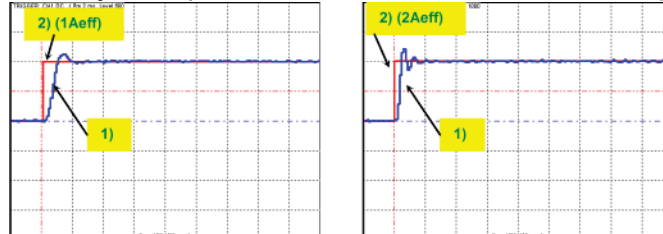

- 1) Actual current
- 2) Setpoint current

In the above figure we can see from the settling response that the drive shows a distinctive tendency to oscillate at doubled current. The saturation characteristic line, which is used to linearly reduce the P-term of the current loop depending on the current, helps against such a saturation behavior.

If you respect the saturation for the above example with the aid of the saturation characteristic line, the tendency to oscillate of the current loop can again be activated.

Current jerk response with the activated saturation characteristic line

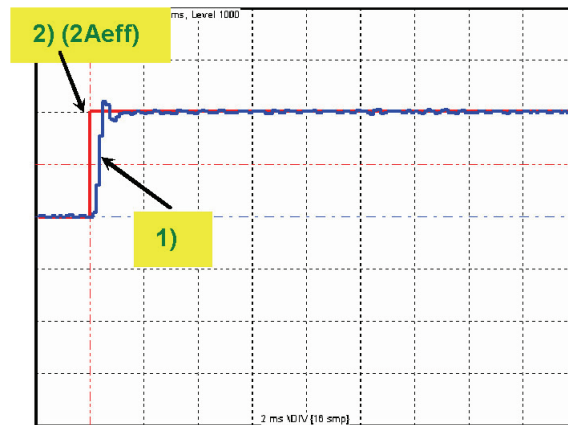

The parameterization of the characteristic line is made in the MotorManager.

- Note:**
- ◆ In order to accept the changes in the MotorManager in the project, the entire configuration must be confirmed.
 - ◆ In order to make the changes from the MotorManager effective in the device, the configuration download must be executed.

Control measures for drives involving friction

In this chapter you can read about:

Deadband following error.....214
 Friction compensation.....215

Some drives, which involve much friction due to their guiding system, may show permanent oscillation at standstill. The transition between static friction (standstill) and kinetic friction (very low speed) is very steep. The controller can not longer follow the friction characteristic line at this position. The I-term integrates until the control variable pulls free the drive and the drive moves too far. This procedure is repeated in the opposite direction and a control oscillation occurs (so-called limit cycle). In order to eliminate this control oscillation, the following control functions were implemented:

- ◆ Deadband following error (Obj. 2200.20)
- ◆ Filter following error (Obj. 2200.24)
- ◆ Friction compensation (Obj. 2200.21)

Deadband following error

Deadband/filter following error in the position loop

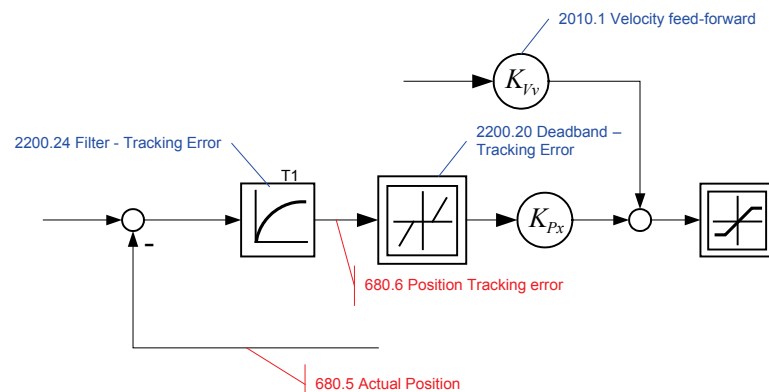

The deadband does no longer supply a velocity setpoint value (zero) for the subordinate velocity loop at small following error. The integrator of the velocity loop stops integrating and the system comes to a standstill.

In order to prevent that the velocity loop is excited by the noise on the following error, the following error should be filtered before the deadband, which will lead, however, to delays in the position loop. The deadband to be set depends on the friction behavior (amplitude of the limit cycle) and on the noise on the following error (the noise must remain within the deadband).

Friction compensation

The activation of the friction compensation (end of the velocity loop)

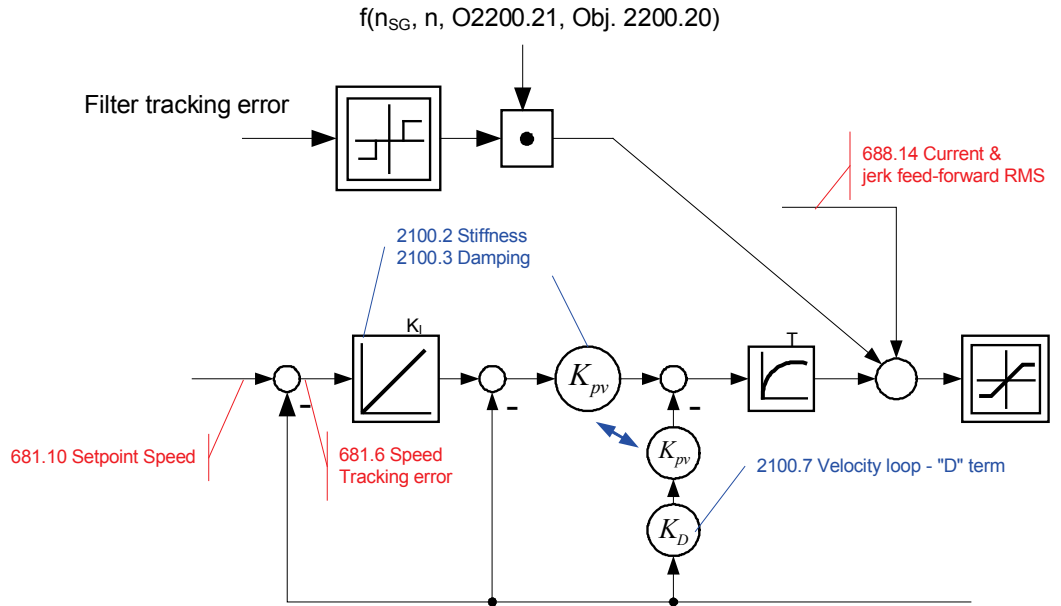

The friction compensation helps the control to surmount static friction at low setpoint speeds. The non linear characteristic line is partly compensated by this and a smaller deadband can be chosen, which will increase the position accuracy. The amplitude of the friction compensation depends on the application and must be calculated if needed. If the value is set too high, corrective movements may result and the tendency to oscillate is increased.

Commissioning window

In this chapter you can read about:

Load identification.....	215
Setpoint generation	215

With the aid of the setup window, the drive can be set up in a simple way.

Load identification

If you do not know the mass moment of inertia, it can be determined. For this, you click on the corresponding button (see setup window no. 13). After the following parameter entry, the identification can be started via the same button.

- ◆ For more detailed information on the load identification, see the device help, chapter "load identification".
- ◆ This measurement requires the correct EMC or torque constant value K_t .

Setpoint generation

In this chapter you can read about:

Internal setpoint generation	215
External setpoint generation	217

The setpoints for the control loops are provided in two different ways - internally or externally. The setpoint generation depends on the technology option of the device.

Internal setpoint generation

The internal setpoint generation can be used for the technology options >T10. In this case, the internal setpoint generator generates the entire motion profile with position, velocity, acceleration and jerk.

Motion profile at jerk-controlled setpoint generation

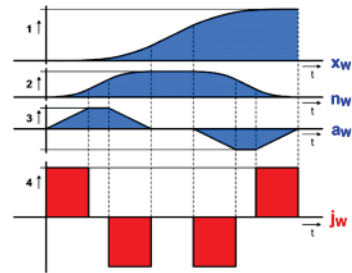

x_w Position
 n_w Velocity
 a_w Acceleration
 j_w Jerk

The drive cannot move randomly through hard profiles, as certain physical limits exist for the acceleration ability due to the motor physics and the limitation of the control variable. You must therefore make sure that the set movement corresponds to the real physics of the motor and of the servo drive.

As a support you can take the following physical correlation.

The calculation of the physically possible acceleration

rotary drives

$$a[rps^2] = \frac{M_A[Nm] - M_L[Nm]}{2\pi \cdot J_{ges}[kgm^2]}$$

M_A: Drive torque of the motor
 M_L: Load torque of the motor
 J_{total}: entire mass moment of inertia
 a: possible acceleration

Linear drives

$$a[m/s^2] = \frac{F_A[N] - F_L[N]}{m_{ges}[kg]}$$

F_A: Drive force of a linear motor
 F_L: Load force of a linear motor
 m_{total}: Total mass of a linear motor

The generation of the setpoint profile is jerk-controlled and jerk-limited by the specification of the jerk.

In practice, jerk-limited setpoint generation is important if the items to be moved must be handled gently. In addition, the service life of the mechanical guiding system will be extended. A separate setting of jerk and slope of the deceleration phase also permits overshoot-free positioning in the target position. For this reason, it is common practice to use higher values for acceleration and jerk in the acceleration phase than in the deceleration phase. In consequence a higher cycle rate can be achieved.

An additional important reason for the jerk limitation is the excitation of higher frequencies due to the too high jerk in the power density spectrum of the velocity function.

Jerk=1000°/s³

Jerk=1000000°/s³

Time function:

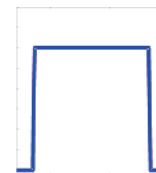

Time function and power density spectrum of Compax3 setpoint generator with different jerk settings

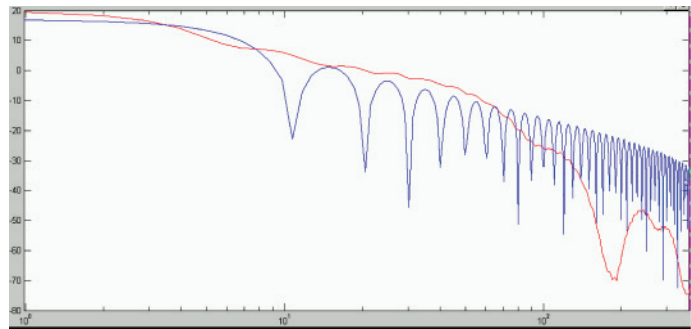

Power density over the frequency

The profile can be simply calculated and displayed for control purposes.

External setpoint generation

During external setpoint generation, the necessary feedforward signals are calculated from the external setpoint with the aid of numerical differentiation and final filtering.

Hint For more detailed information on the external setpoint generation see device help for T11/T30/T40 devices in the "setup" chapter Compax3\optimization\controller dynamics\signal filtering at external setpoint specification"

Test Move

In order to evaluate the behavior of the drive, test movements can be defined. For this you jump into the parameter entry either with the aid of the "enter setup/test movement parameters" or by selecting the parameter tab. Via the "setup settings" menu you access the settings for the desired test movement. The desired motion profile can be set via the parameters in the following window.

Proceeding during controller optimization

In this chapter you can read about:

Main flow chart of the controller optimization 218
 Controller optimization disturbance and setpoint behavior (standard) 219
 Controller optimization disturbance and setpoint behavior (advanced)..... 221

If the control behavior is not sufficient for the present application, an optimization is required. We recommend the following approach:

Overview on the approach to setup + optimization

- ◆ At first, the disturbance and setpoint behavior of the velocity loop at standstill and at different displacement velocities is optimized (stiffness, attenuation, filter).
- ◆ After that, the necessary motion profiles are set via the setup tool and the desired guiding behavior in the entire velocity range is set via the feedforward control (motion profiles, feedforward).

Main flow chart of the controller optimization

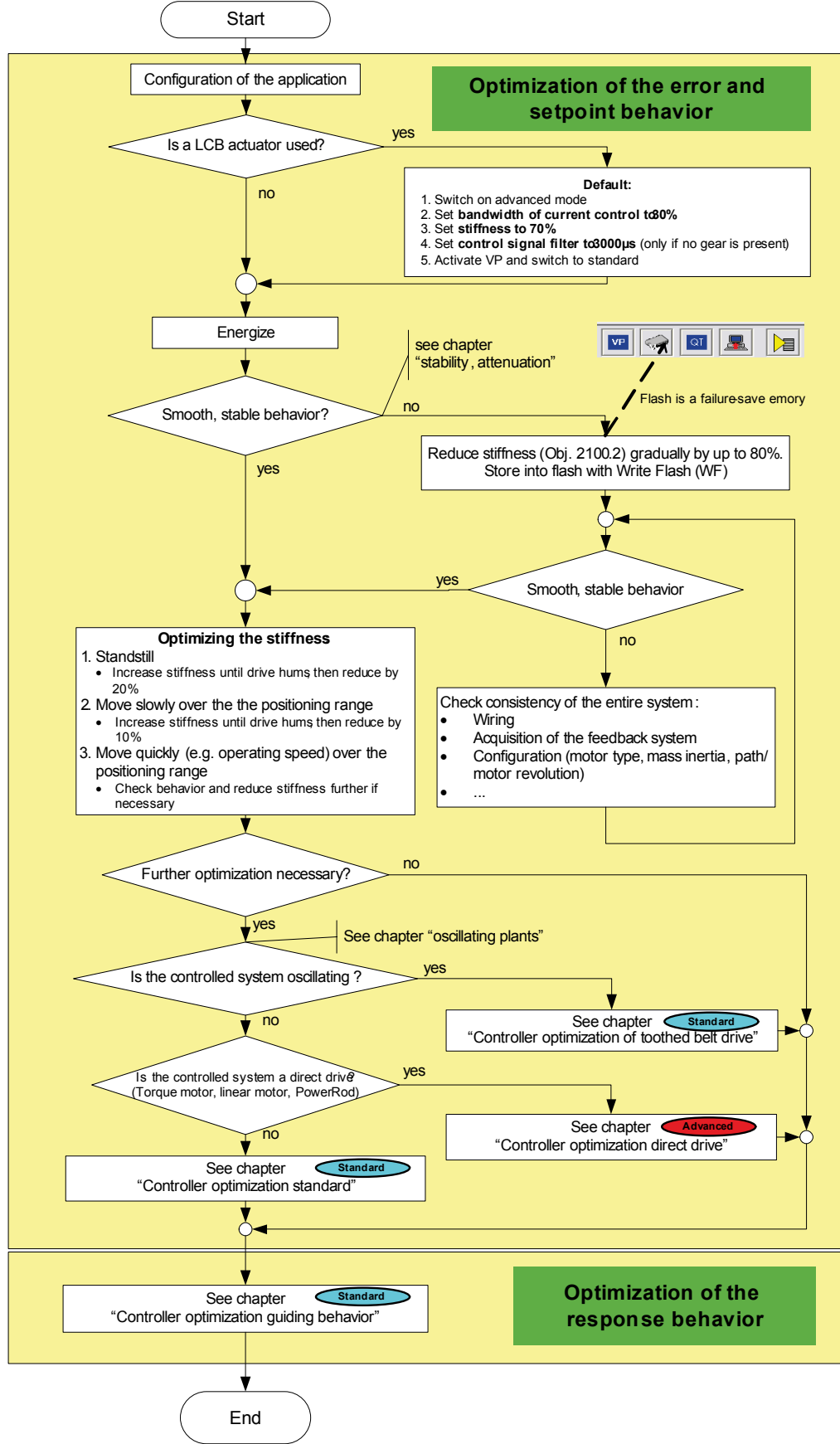

Controller optimization disturbance and setpoint behavior (standard)

In this chapter you can read about:

Controller optimization standard 219
 Controller optimization of toothed belt drive 220

Controller optimization standard

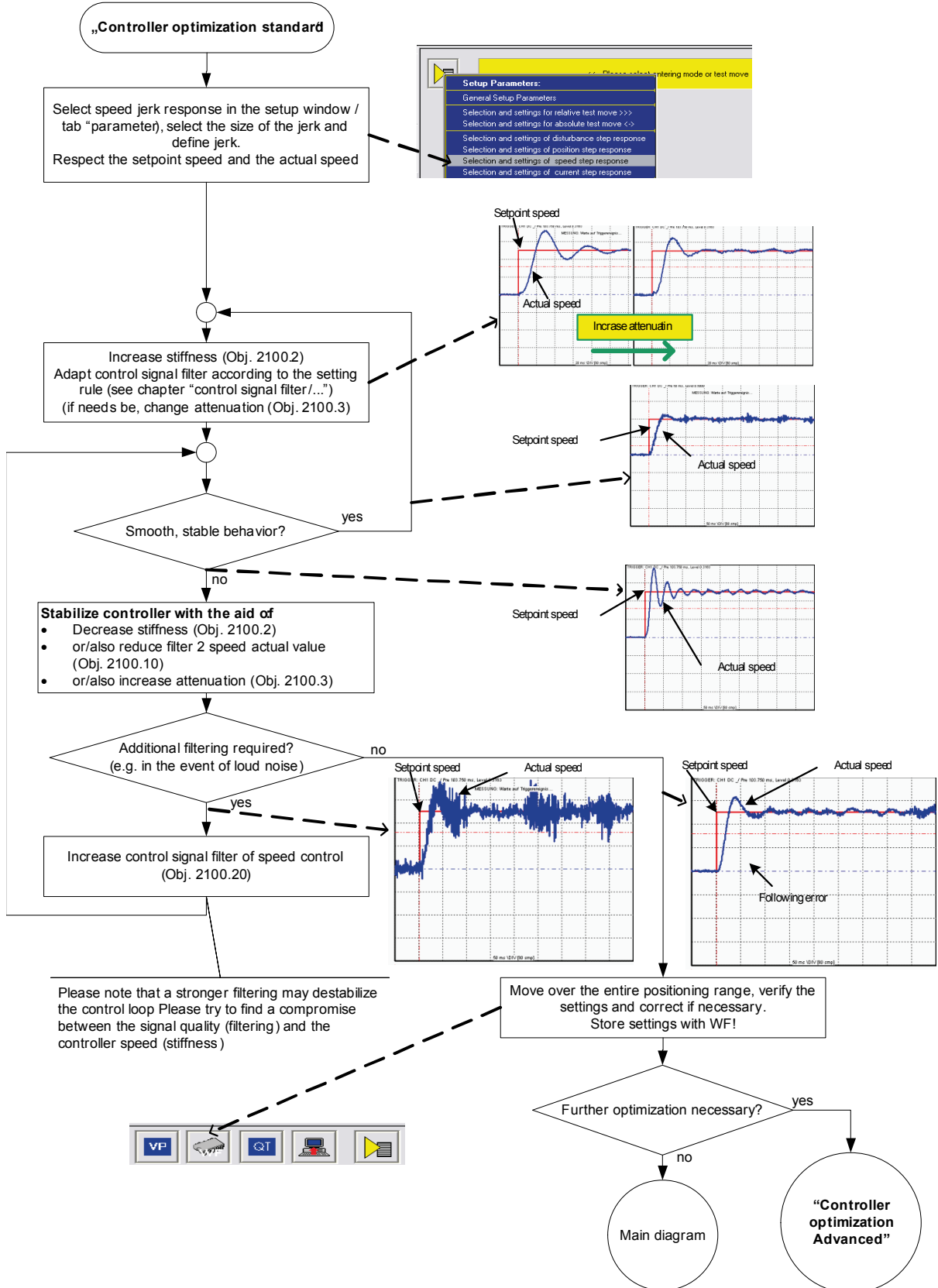

Controller optimization of toothed belt drive

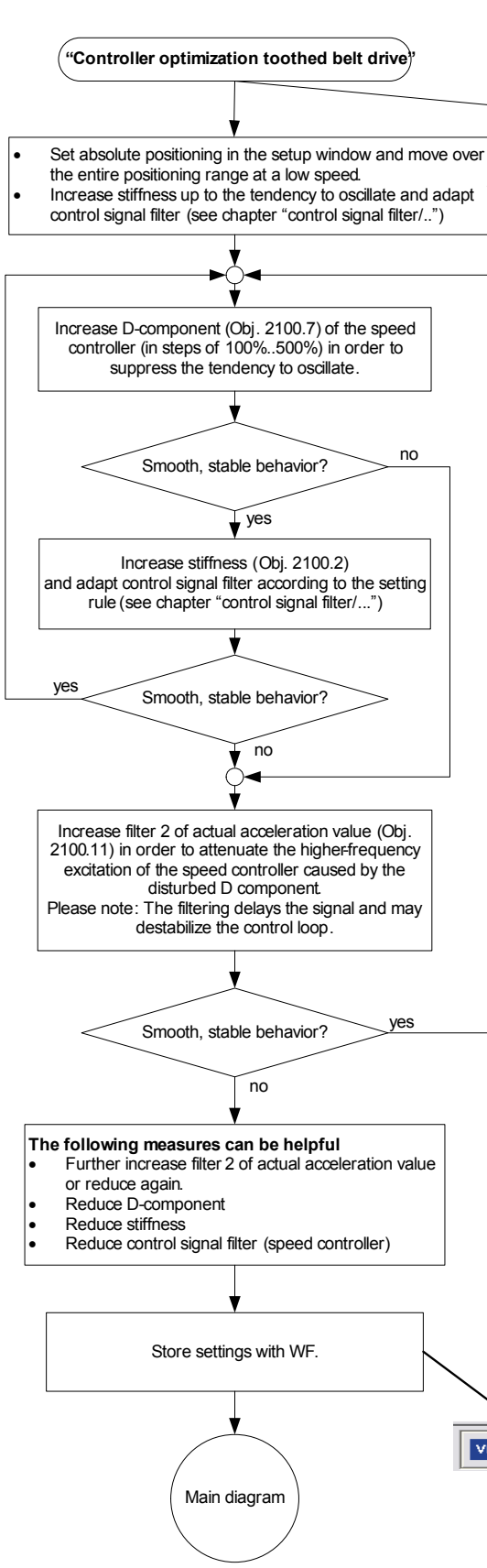

- The stiffness of a drive able to oscillate can be increased by using the D-component. If the D-component is too large, the control is destabilized.
- Due to the twofold position differentiation the D-component is rather disturbed and may excite the control loop in the higherfrequency range. The filtering of the dcomponent with the aid of the "filter2 of actual acceleration value" can activate the higherfrequency components at the cost of the dynamics
- The correct combination of the 3 parameters will lead to the best control results.
- The D-component is set in%. The value range: 0..4000000%.
- Values up to 5000 are common.

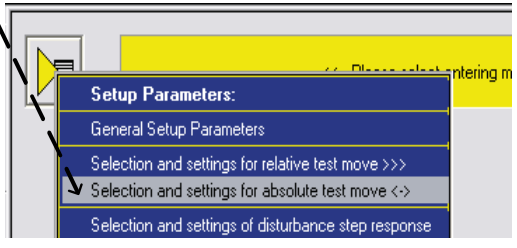

Controller optimization disturbance and setpoint behavior (advanced)**In this chapter you can read about:**

Controller optimization Advanced	222
Flow chart controller optimization of a direct drive.....	223
Controller optimization guiding transmission behavior.....	224

Controller optimization Advanced

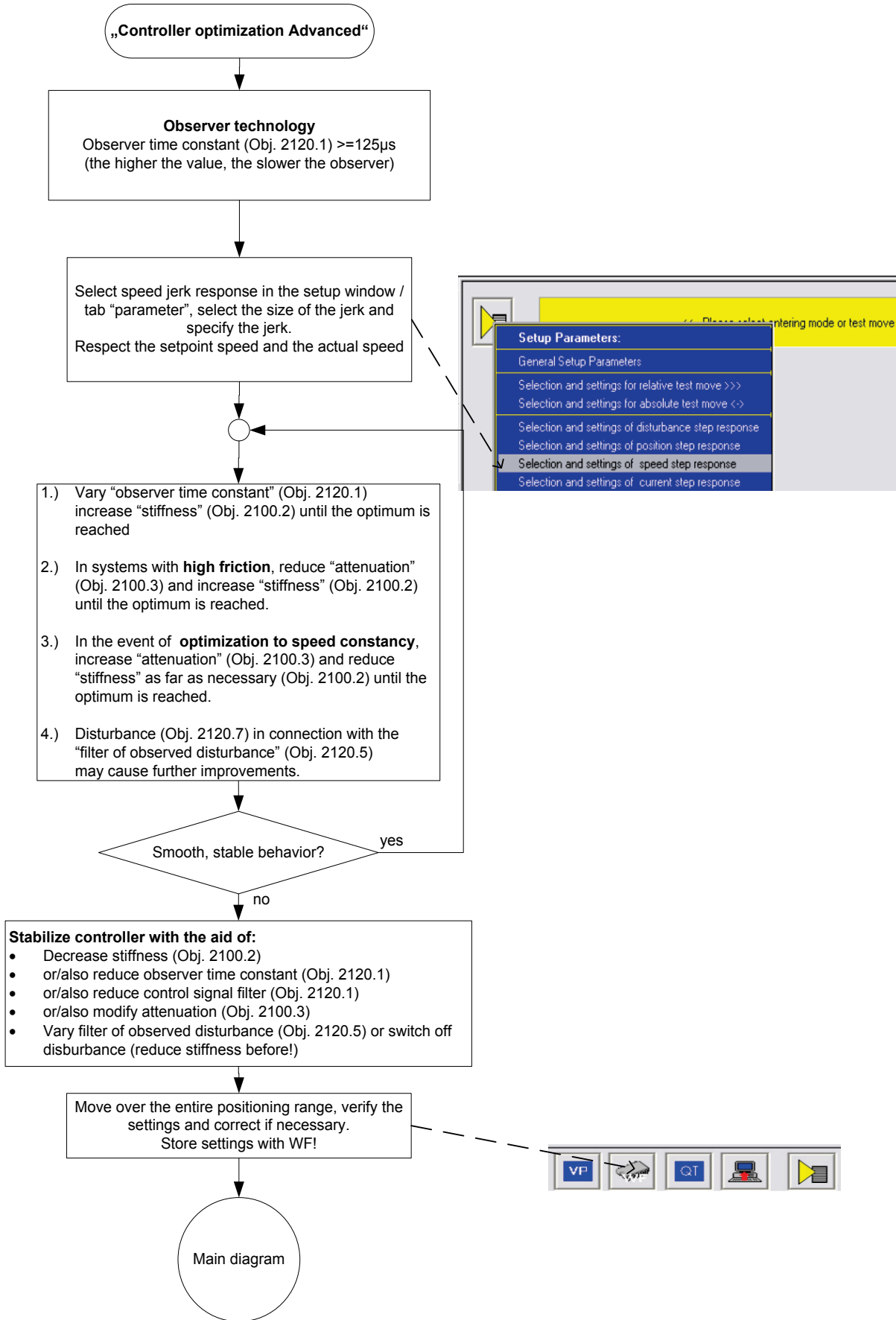

Flow chart controller optimization of a direct drive

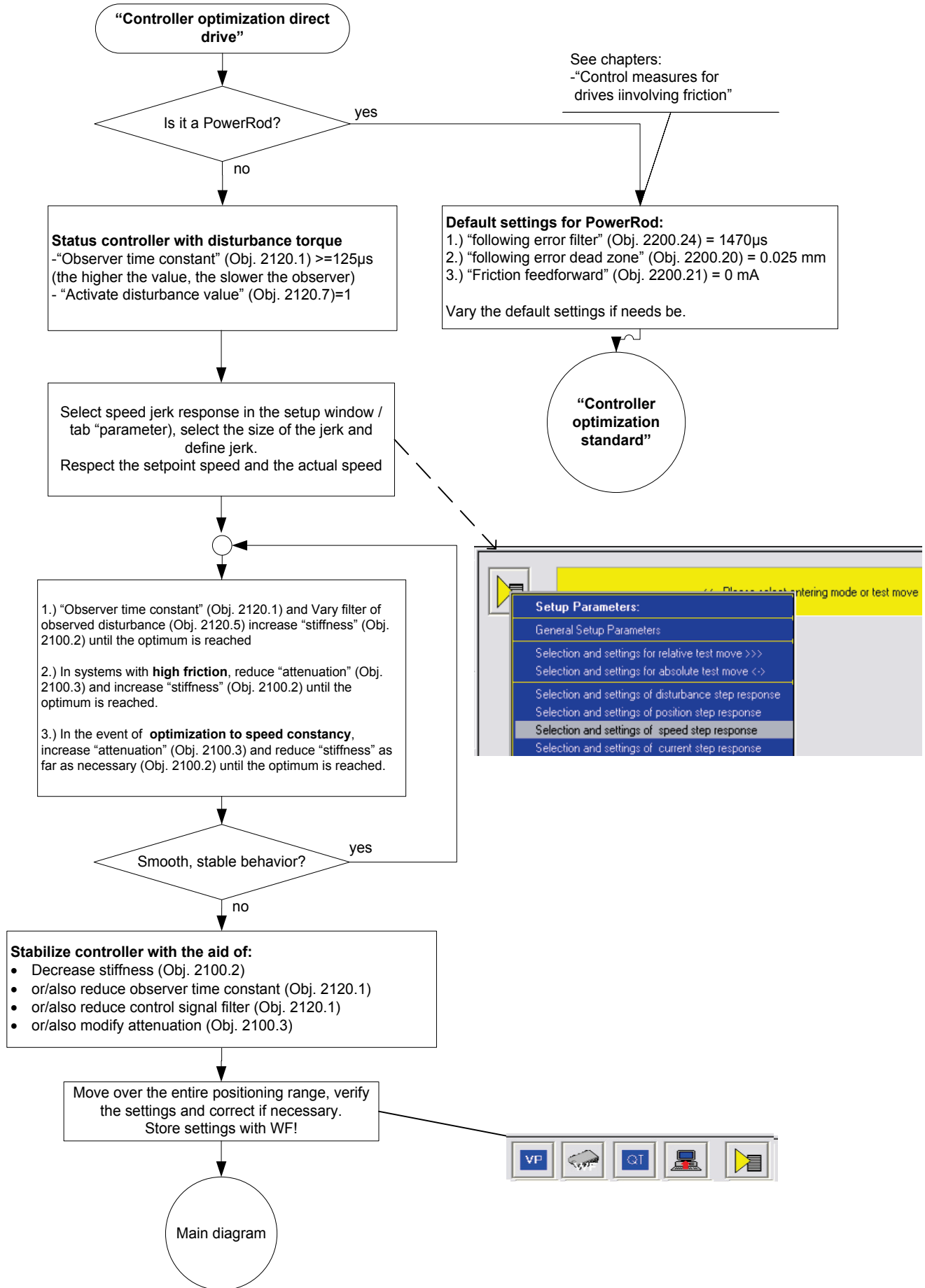

Controller optimization guiding transmission behavior

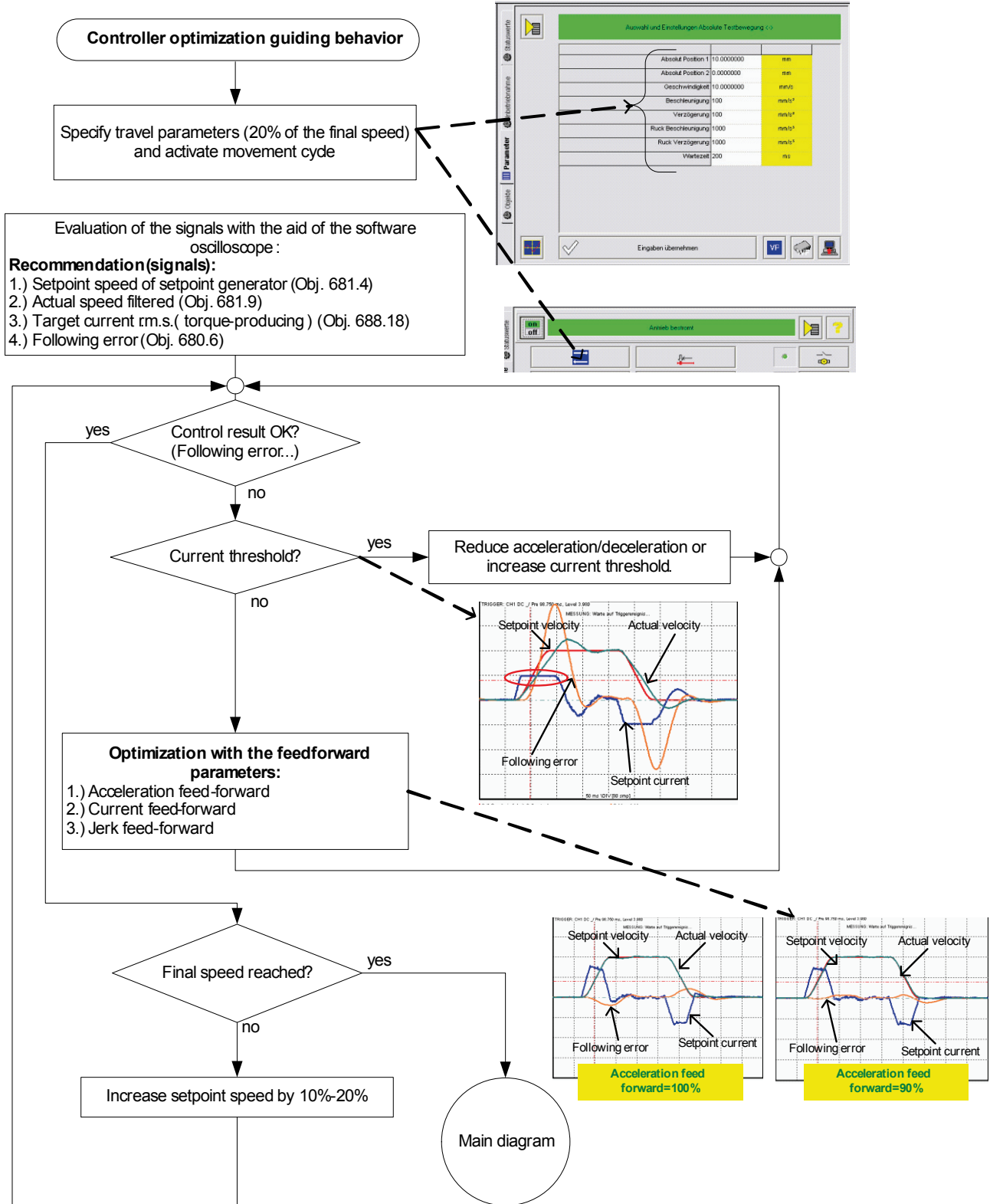

4.4.4. Signal filtering with external command value

The command signal read in from an external source (via HEDA or physical input) can be optimized via different filters. For this the following filter structure is available:

4.4.4.1 Signal filtering for external setpoint specification and electronic gearbox

Does not apply for Compax3111T11!

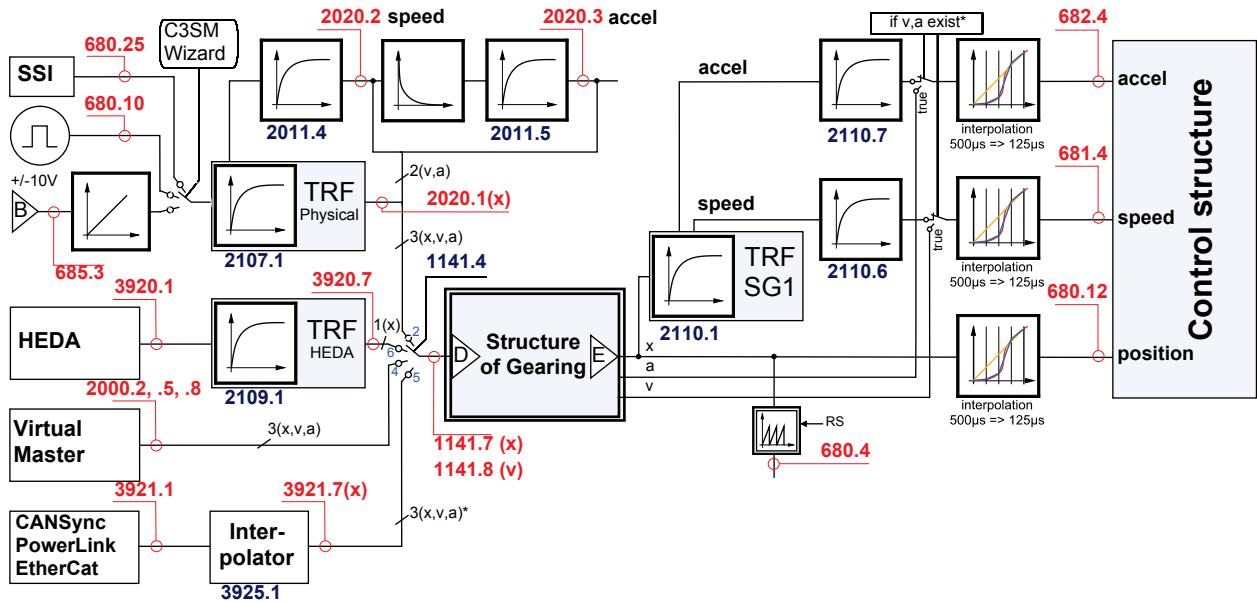

"virtual Master" and Busmaster only with T30 & T40.

* Speed v and acceleration a are only present in the event of linear interpolation (method of interpolation: O3925.1 - 0x60C0) if they are provided by an external source.

In quadratic or cubic interpolation, v and a are emulated.

B: **Structure image of the signal processing**,

D/E: Structure of Gearing

Control structure (see on page 195, see on page 200, see on page 202)

Symbols

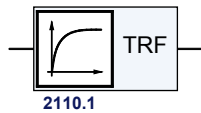

Tracking filter

The displayed filter influences all outputs of the tracking filter.

Number: Object number of the filter characteristic



Differentiator

Output signal = $d(\text{input signal})/dt$

The output signal is the derivation (gradient) of the input signal

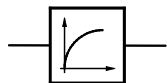

Filter

Number: Object number of the filter characteristic

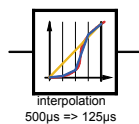

Interpolation

Linear Interpolation.

Values in the 500µs grid are converted into the more exact time grid of 125µs.

Note:

- ◆ A jerk setpoint generator is not required for external setpoint specification.
- ◆ The description of the objects can be found in the **object list** (see on page 295).

4.4.5. Input simulation

Function: The input simulation is used for the performance of tests without the complete input/output hardware being necessary. The digital inputs (standard and inputs of M10/M12 option) as well as the analog inputs are supported. The following operating modes are available for digital inputs:

- ◆ The physical inputs are deactivated, the digital inputs are only influenced via the input simulation.
- ◆ The digital inputs and the physical inputs are logically or-linked. This necessitates very careful action, as the required function is, above all with low-active signals, no longer available.

The pre-setting of an analog input value is always made in addition to the physical analog input.

The function of the inputs depends on the Compax3 device type; please refer to the respective online help or the manual.

The input simulation is only possible if the connection with Compax3 is active and if the commissioning mode is deactivated!

In this chapter you can read about:

Calling up the input simulation	226
Operating Principle	226

4.4.5.1 Calling up the input simulation

Open the optimization window (double click in the C3 ServoManager tree entry: Optimization).
 Activate the Tab “Setup” in the right lower window.
 Clicking on the following button will open a menu; please select the input simulation.



4.4.5.2 Operating Principle

Window Compax3 InputSimulator:

1. Row: Standard Inputs E7 ... E0 = “0” button not pressed; = “1” switch pressed

2. Row: Optional digital inputs (M10 / M12)

Green field: port 4 is defined as input

Red field: port 4 is defined as output

the least significant input is always on the right side

3. Row: If the button “deactivating physical inputs” is pressed, all physical, digital inputs are deactivated; only the input simulation is active.

If both sources (physical and simulated inputs) are active, they are or-linked!



Caution!

Please consider the effects of the or-linking; above all on low-active functions.

4. Row: Simulation of the analog inputs 0 and 1 in steps of 100mV.

The set value is added to the value on the physical input.

After the input simulation has been called up, all simulated inputs are on “0”.

When the input simulation is left, the physical inputs become valid.

4.4.6. Setup mode

The setup mode is used for moving an axis independent of the system control
The following functions are possible:

- ◆ Homing run
- ◆ Manual+ / Manual-
- ◆ Activation / deactivation of the motor holding brake.
- ◆ Acknowledging errors
- ◆ Defining and activating a test movement
- ◆ Activating the digital outputs.
- ◆ **Automatic determination of the load characteristic value** (see on page 229)
- ◆ Setup of the **load control** (see on page 153)

Activating the commissioning mode



By activating the setup mode, the Steuerungsprogramm (IEC-Programm) is deactivated; the system function of the device is no longer available.

Access via an interface (RS232/RS485, Profibus, CANopen,...) and via digital inputs is deactivated. (if necessary, acyclic communication ways are nevertheless possible (e.g. Profibus PKW channel))

Caution!

**The safety functions are not always guaranteed during the setup mode!
This will for instance lead to the fact that the axis may trundle to a stop if the Emergency stop button is pressed (interruption of the 24 V on C3S X4.3), which requires special caution with z axes!**

- ◆ In the Commissioning window (left at the bottom) the commissioning mode is activated.
- ◆ Then parameterize the desired test movement in the Parameter window.
You can accept changed configuration settings into the current project.
- ◆ Now energize drive in the commissioning window and start the test movement.



Caution! Safeguard the travel range before energizing!

Deactivating the commissioning mode



If the setup mode is left, the drive is deactivated and the Steuerungsprogramm (IEC-Programm) is re-activated.

- Note:**
- ◆ The parameters of the commissioning window are saved with the project and are loaded into Compax3 if the commissioning mode is activated (see explanation below).

4.4.6.1 Motion objects in Compax3

The motion objects in Compax3 describe the active motion set.

The motion objects can be influenced via different interfaces.

The following table describes the correlations:

Source	active motion objects		Compax3 device
	==>	describe	
	<==	read	
<u>Commissioning</u> (working with the commissioning window)	==>	<ul style="list-style-type: none"> ◆ With the "accept entry" button. ◆ The current project gets a motion set. Download by activating the motion 	Active motion objects: <ul style="list-style-type: none"> ◆ Position [O1111.1] ◆ Speed [O1111.2] ◆ Acceleration [O1111.3] ◆ Deceleration [O1111.4] ◆ jerk* [O1111.5] (Acceleration) ◆ Jerk* [O1111.6] (Deceleration) <p>* for IxxT11 - devices, both jerk values are identical</p>
	<==	<ul style="list-style-type: none"> ◆ On the 1st. Opening the commissioning window of a new project for the first time. ◆ Activated via the "Upload settings from device" button (bottom at the left side). 	
<u>Compax3 ServoManager project</u>	==>	<ul style="list-style-type: none"> ◆ C3IxxT11: via an activated motion set ◆ C3I2xT11: via a configuration download 	
	<==	For Compax3 I2xT11: <ul style="list-style-type: none"> ◆ via a configuration upload ◆ in the commissioning window via "accept configuration" 	
<u>Fieldbus (Compax3 I2xTxx)</u>	==>	<ul style="list-style-type: none"> ◆ Changing the motion objects directly 	
	<==	<ul style="list-style-type: none"> ◆ Reading the motion objects 	
<u>IEC61131-3 program</u> (Compax3 IxxT30, IxxT40)	==>	<ul style="list-style-type: none"> ◆ via positioning modules 	

4.4.7. Load identification

Automatic determination of the load characteristic value:

- ◆ of the mass moment of inertia with rotary systems
- ◆ of the mass with linear systems.

In this chapter you can read about:

Principle	229
Boundary conditions	229
Process of the automatic determination of the load characteristic value (load identification).....	230
Tips	231

4.4.7.1 Principle

The load characteristic value is automatically determined.

For this it is necessary to excite the system additionally with a signal (excitation signal = noise).

The excitation signal is fed into the control loop. The control loop dampens the excitation signal. Therefore, the superimposed control loop is set so slowly by reducing the stiffness, that the measurement is not influenced.

A superimposed test movement is additionally possible. This helps to eliminate possible mechanical effects such as rubbing caused by friction.

4.4.7.2 Boundary conditions

If the control is instable before the beginning of the measurement, please reduce the stiffness (in the optimization window at the left bottom)

The following factors can disturb a measurement:

- ◆ Systems with high friction (e.g. linear actuators with sliding guide)
Here, the systems where the static friction is considerably higher than the kinetic friction (slip-stick effect) are especially problematic.
- ◆ Systems with significant slack points (play)
- ◆ Systems with "too light" or susceptible to oscillation bearing of the total drive (rack).
Formation of rack resonances. (e.g. with gantries,...)
- ◆ Non constant disturbance forces which influence the speed development. (e.g. extremely strong slot moments)

The effects of the factors one to three on the measurement can be reduced by using a test movement.

Caveat emptor (exclusion of warranty)

Due to multiple possibilities for disturbing influences of a real control path, we cannot accept any liability for secondary damages caused by faultily determined values. Therefore it is essential to verify all values automatically determined before loading them into the control loop.

4.4.7.3 Process of the automatic determination of the load characteristic value (load identification)

- ◆ Please click on "unknown: default values are used" in the configuration wizard in the "External moment of inertia" window.
- ◆ After the configuration download, you can enter directly, that the optimization window is to be opened.
- ◆ In the Commissioning window (left at the bottom) change to commissioning mode.
- ◆ Finally enter the values of the excitation signal and of the test movement in the parameter window.
Parameters of the excitation signal:
 - ◆ Amplitude of the excitation signal in % of the motor reference current
Only an amplitude value causing a distinct disturbance can give a usable result.
 - ◆ permissible following error
In order to avoid a following error caused by the excitation signal, the permissible following error must be increased for the measurement if necessary.
 - ◆ Selection of the test movement: inactive, reverse, continuous
 - ◆ Parameterizing of the test movement if necessary
- ◆ Now energize drive and open load identification window in the commissioning window.



Caution! Safeguard the travel range before energizing!

- ◆ Starting the load identification.



Caution! The drive will perform a jerky movement during load identification!

- ◆ After the measurement, the values can be accepted. Depending on the application, 2 measurements for minimum external load and maximum external load are recommended.

4.4.7.4 Tips

Tip	Problem	Measures
1	Speed too low (with reverse operation)	Increase maximum speed and adapt travel range*
2	Speed too low (with continuous operation)	Increase maximum speed
3	Test movement missing	A test movement is important for drives with high friction or with mechanical slack points (play).
4	No error detected	Please note the boundary conditions (see on page 229).
5	Speed too low and amplitude of the excitation signal too small (with reverse operation)	Increase amplitude of the excitation signal; increase maximum speed and adapt travel range*
6	◆ Speed too low and ◆ amplitude of the excitation signal too small (with continuous operation)	Increase amplitude of the excitation signal; increase maximum speed.
7	◆ Test movement missing ◆ amplitude of the excitation signal too small	◆ Increase amplitude of the excitation signal or / and ◆ activate an appropriate test movement
8	amplitude of the excitation signal too small	Increase the amplitude of the excitation signal.
9	Following error occurred	Increase the parameter "permissible following error" or decrease the amplitude of the excitation signal.

*if the travel range is too short, the speed is not increased, as the drive does not reach the maximum speed.

4.4.8. Alignment of the analog inputs

In this chapter you can read about:

Offset alignment 231
 Gain alignment 232
 Signal processing of the analog inputs 232

There are two possibilities to align the analog inputs in the optimization window:

- ◆ Wizard-guided under commissioning: Commissioning functions (click on the yellow triangle with the left mouse button:

Attention”

This wizard guided automatic alignment does not work if you bridge Ain+ with Ground for the alignment!

In this case, please make a manual alignment as described below.

or

- ◆ by directly entering under optimization: Analog Input

4.4.8.1 Offset alignment

Performing an offset alignment when working with the ±10V analog interface in the optimization window under optimization: Analog input Offset [170.4].

Enter the offset value for 0V input voltage.

The currently entered value is shown in the status value "analog input" (optimizing window at the top right) (unit: 1 = 10V). Enter this value directly with the same sign as offset value.

The status value "analogue input" shows the corrected value.

4.4.8.2 Gain alignment

Performing an offset alignment when working with the $\pm 10V$ analog interface in the optimization window under optimization: Analog input: Gain [170.2].
 A gain factor of 1 has been entered as default value.
 The currently entered value is shown in the status value "analog input" (optimizing window at the top right).
 The status value "analogue input" shows the corrected value.

4.4.8.3 Signal processing of the analog inputs

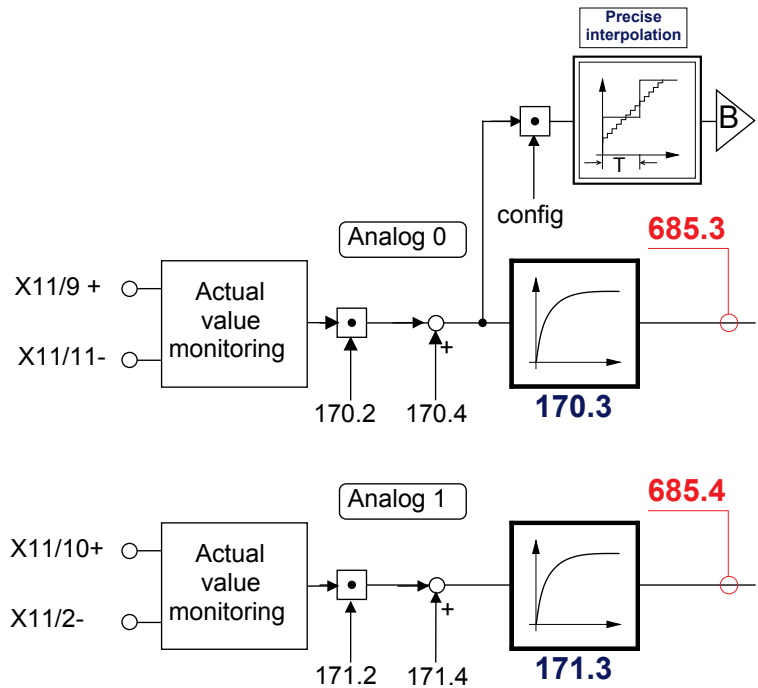

B: Continuitive structure image (see on page 224)

4.4.9. C3 ServoSignalAnalyzer

In this chapter you can read about:

ServoSignalAnalyzer - function range	233
Signal analysis overview	234
Installation and activation of the ServoSignalAnalyzer	235
Analyses in the time range	236
Measurement of frequency spectra	239
Measurement of frequency responses	242
Overview of the user interface	248
Basics of frequency response measurement	261

4.4.9.1 ServoSignalAnalyzer - function range

The function range of the ServoSignalAnalyzer is divided into 2 units:

Analysis in the time range

This part of the function is freely available within the Compax3 ServoManager. The Compax3 ServoManager is part of the Compax3 servo drive delivery range.

Analysis in the frequency range

This part of the function requires a license key which you **can buy** (see on page 235).

The license is a company license and must only be bought once per company. For each PC you need however an individual key, which you can request individually.

4.4.9.2 Signal analysis overview

The ServoSignalAnalyzer offers three basic methods of analyzing systems:

- ◆ Analysis in the time range by measuring the step response
- ◆ Spectral analysis of individual signals
- ◆ Measurement of frequency response (Bode diagram) of the position control or of individual parts of the control as well as of the control path

These functions are available in the Compax3 ServoManager after the **activation** (see on page 235) with the aid of a system-dependent key.

You do not require expensive and complex measurement equipment -> a Compax3 device and a PC will do!

Basic structure of the signal analysis

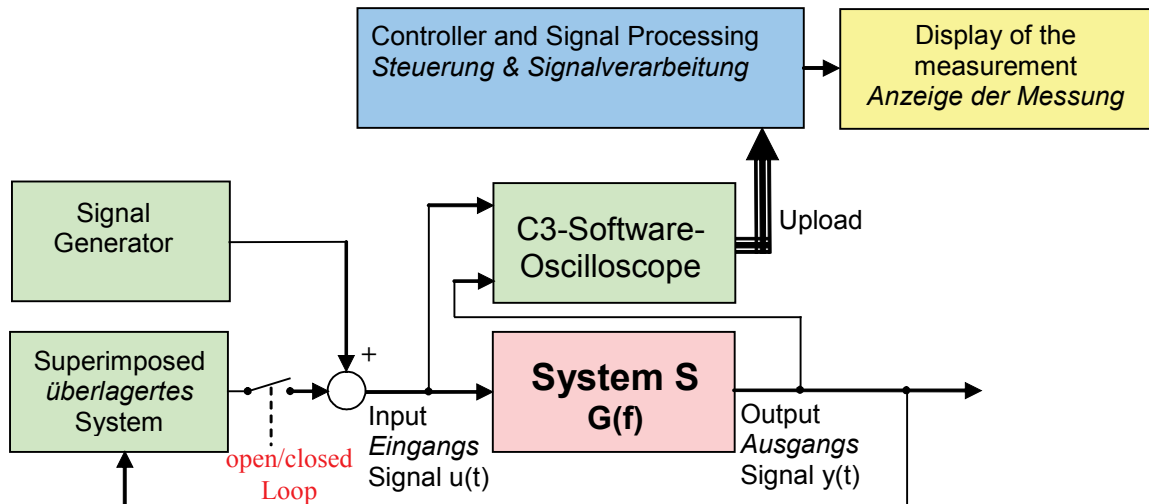

Systems / signals

Depending on the kind of measurement, the SignalAnalyzer can help analyze the most different signals and systems.

Signal generator

This allows to inject different excitation signals (step, sine and noise signals) into the control loop.

Superposed system

For different analyses, superposed systems must be manipulated in order to allow a measurement. After the measurement, the changes made for this purpose are reset

C3 software oscilloscope

With the aid of the software oscilloscope, the contents of different objects can be registered and be loaded into the PC for further analysis.

Control and signal processing

The control of the entire measurement as well as the processing of the uploaded sample data are made in the PC.

4.4.9.3 Installation and activation of the ServoSignalAnalyzer

- ◆ Compax3 with up-to-date controller board (CTP 17)
- ◆ Firmware version R06-0 installed
- ◆ Execution of the C3 ServoManager Setup (on CD)
- ◆ If the firmware is too old => update with the aid of the firmware from the CD

Activation

In order to being able to use the analysis functions in the frequency range (for example frequency response measurement), a software activation is required.

Please observe:

The activation is only valid for the PC on which it was performed!

Caution! If the PC disposes of network adapters which are removed at times (e.g. PCMCIA cards or notebook docking stations), these adapters should be removed before generating the key!

In order to activate the ServoSignalAnalyzer, please follow these steps:

- ◆ Start the Compax3 ServoManager.

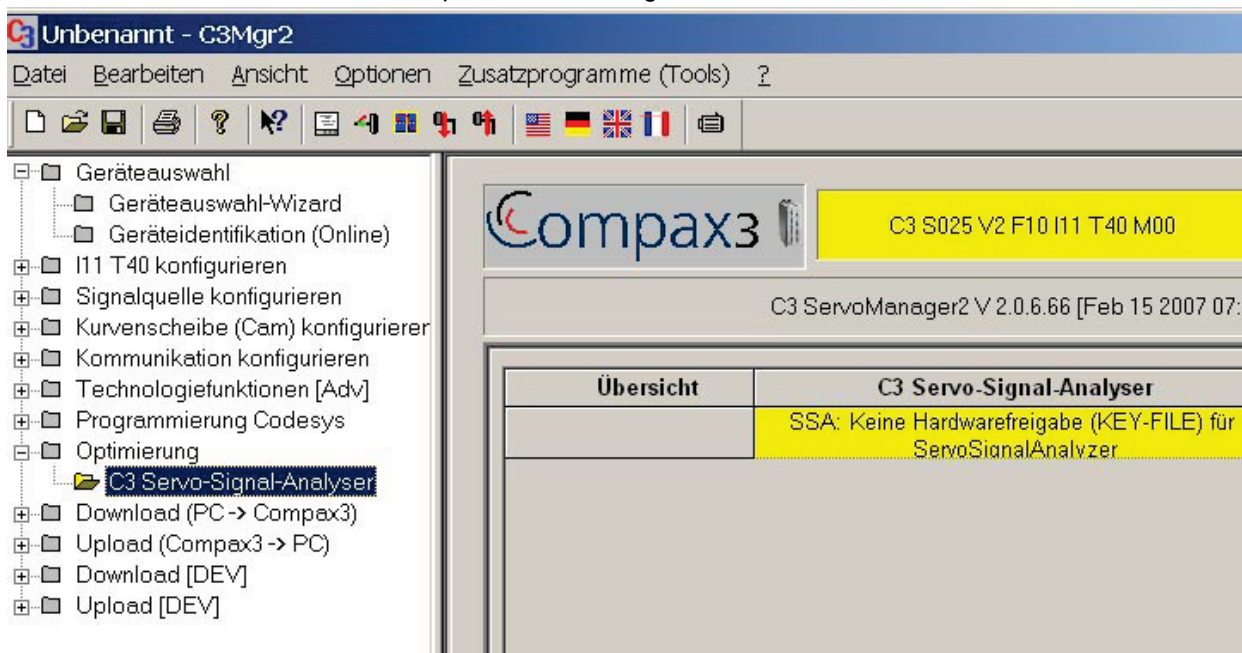

- ◆ Select the C3 ServoSignalAnalyzer in the function tree under optimization.
In the right part of the window you can see the note that no key file was found.
- ◆ A double click on the preselected C3 ServoSignalAnalyzer will generate a system-dependent key.

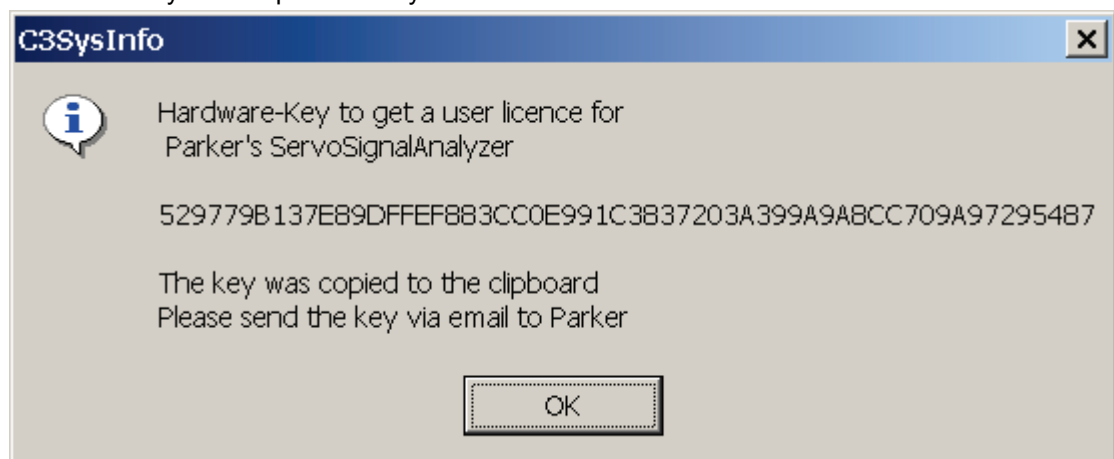

- ◆ Acknowledge with OK and enter the key, which is on your clipboard, into an e-mail, which you please send to **eme.ssalicence@parker.com** (**mailto:eme.ssalicence@parker.com**).
- ◆ After receipt of the reply, copy the attached file "C3_SSA.KEY" into the C3 ServoManager directory (C:\Programs\Parker Hannifin\C3Mgr2\).
- ◆ => the software is activated.

4.4.9.4 Analyses in the time range

Selection and parameterization of the desired analysis function

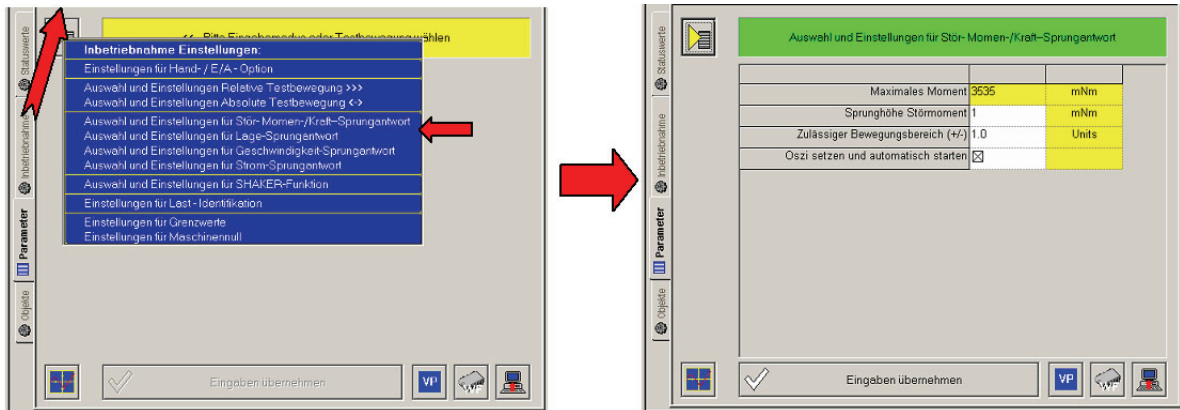

Exemplary step function

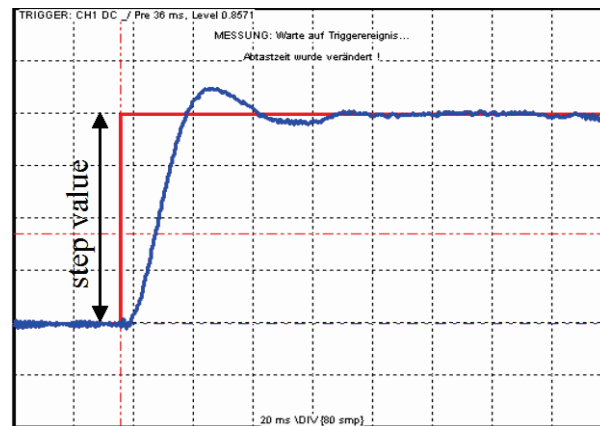

step Value = Step Size

The following functions are available:

Position demand value step: For analysis of the demand value behavior of the position control

Step value < (admissible motion range / 2)

=> even a 100% overshoot does not incite an error message

Speed demand value step: For analysis of the demand value behavior of the speed control

The position control is switched off during the measurement, this might lead in exceptional cases to a slow drift of the position.

Furthermore you should make sure that the selected speed step value corresponds to the parameterized admissible motion range.

Step value < (admissible motion range / time of measurement)

with time of measurement > 2s

Current demand value step: For analysis of the demand value behavior of the current control

The current setpoint jerk is set at the end of the oscilloscope recording time, but is reset to 0 after max. 50mS.



Caution!

- ◆ Many systems are not stable without control!
- ◆ Position as well as speed control are switched off during measurement => **no measurement on z-axes!**

Disturbance torque / force step response: For analysis of the disturbance value behavior of the control

The step of an external disturbance force is simulated and the reaction of the controller is registered.

Shaker function

For this, a sine signal is injected to the current which is used to excite the mechanic system. This allows to analyze the oscillation behavior - what oscillates at which frequency.

Basic settings of the analysis functions:

Maximum torque / maximum current / maximum speed (display):

This is used as a lead for the selection of a suitable step value and indicates which maximum step value is possible.

Step value:

Gives the value of a step.

Permissible motion range (+/-):

- ◆ Indication, in which position window the axis may move during the analysis.
- ◆ This range is not left even in the event of an error.
- ◆ If the drive approaches the limits of the motion range, the controller will decelerate so that the drive will come to a standstill within the permitted motion range. The maximum permitted velocity is used to calculate the deceleration ramp, therefore the drive stops even before reaching the range limits and reports an error.
- ◆ Please make sure that a sufficiently large movement is set for the measurement and that it will be reduced by a high maximum permitted velocity.
- ◆ The motion range monitoring is especially important during current step responses, as position as well as speed control are deactivated during the measurement.

Max permitted speed

When exceeding this value, an error is triggered, the controller decelerates and reports an error.

When measuring the velocity setpoint jerk, the maximum permitted velocity is set to twice the step height.

Setting and automatic start of the oscilloscope:

After pressing "accept entries", the parameters of the oscilloscope (such as scanning time and the assignment of the individual channels) are automatically set to default values according to the respective step value.

When starting the step function, the oscilloscope is automatically started.

Start of the measurement

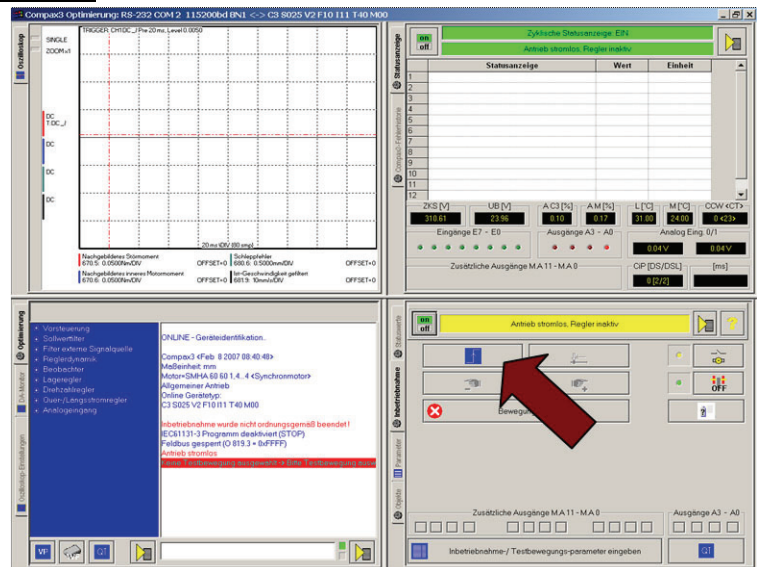

The start of the step function is made with the aid of the highlighted button.

4.4.9.5 Measurement of frequency spectra

Please note that you require a license key (see on page 235, see on page 233) for this application!

In this chapter you can read about:

Functionality of the measurement.....239
 Leak effect and windowing.....240

Functionality of the measurement

Measurement of the spectral analysis

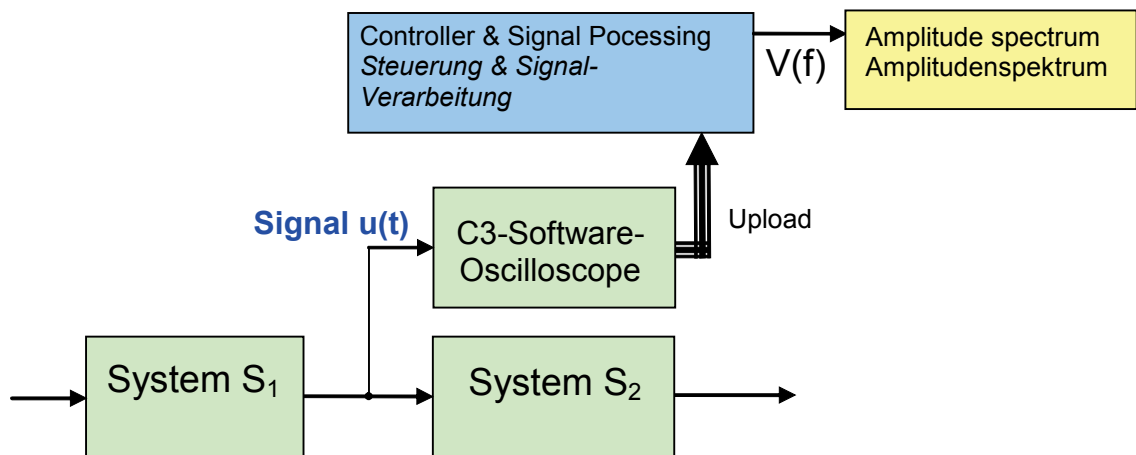

During the spectral analysis of scanned signals with the aid of the discrete Fourier transformation, a so-called frequency resolution (Δf) results, Δf being $=fA/N$, independently of the scanning frequency (fA) and of the number of measurement values used (N).
 The spectra of scanned signals are only defined for frequencies, which are an integer multiple of this frequency resolution.

Interpretation of the frequency spectrum

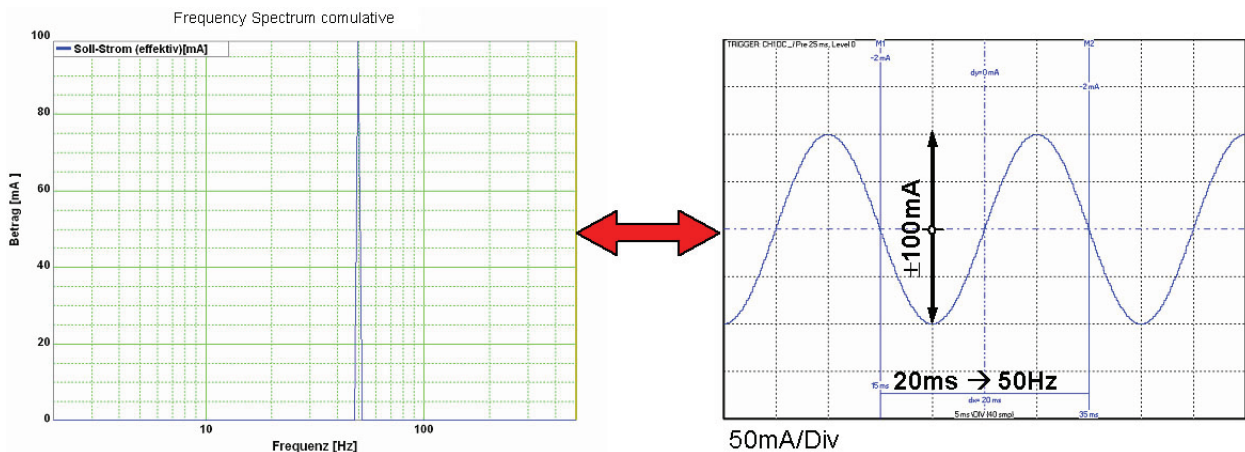

Leak effect and windowing

If frequencies not corresponding to the frequency resolution are present in the analyzed spectrum, the so-called leak effect can be caused.

Display of the leak effect with the aid of a 16 point discrete Fourier transformation

Complete oscillation period in the scanning period

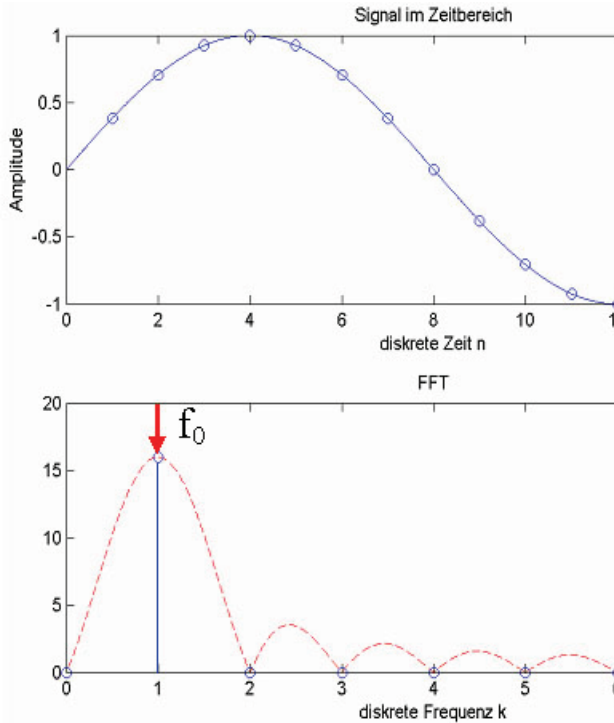

Envelope without leak effect

Non complete oscillation period in the scanning period

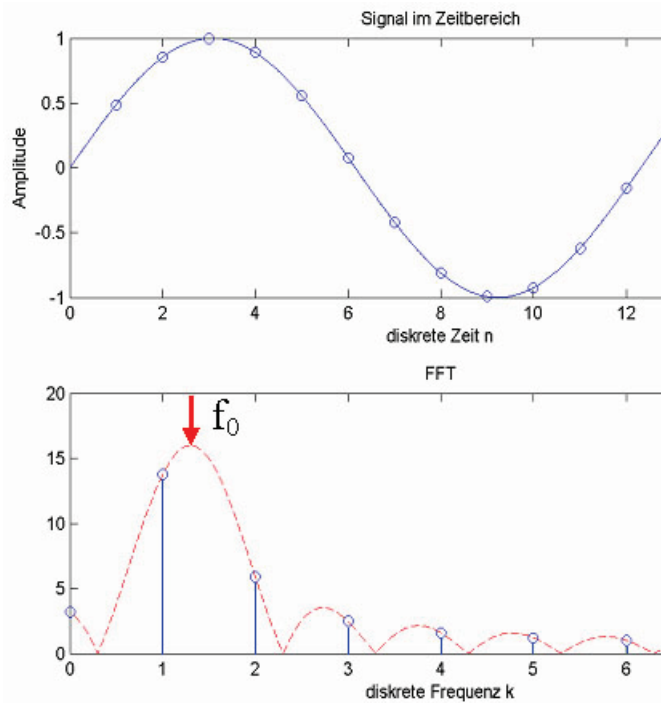

Envelope with leak effect

Sine at 200Hz without windowing

Consequence of the leak effect shown at the example of a sine signal.

($f_A=4000\text{Hz}$; $N=500$; $\Rightarrow \Delta f=8\text{Hz}$)

$f_0=200\text{Hz} = 25 \cdot \Delta f$ frequency corresponds to the frequency-resolution

spectrum cumulative

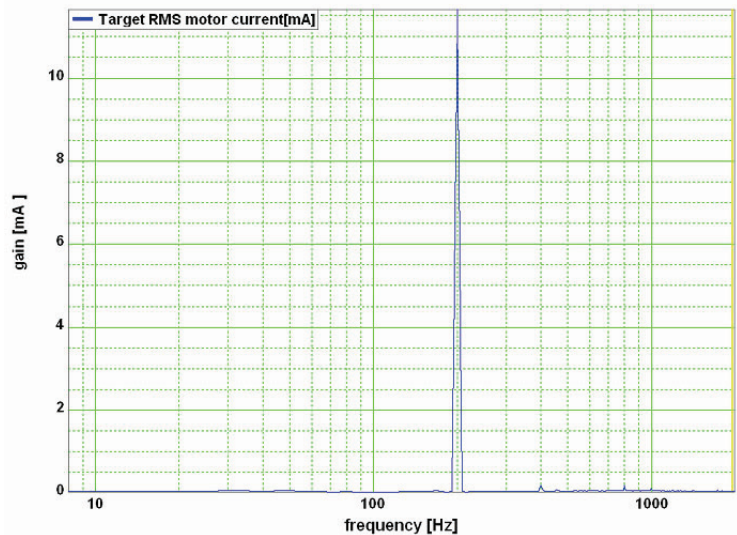

The sine frequency is exactly on a multiple of the frequency resolution (200Hz / 8Hz=25). The spectrum is clearly separated and there are no leak effects visible.

Sine at 204Hz

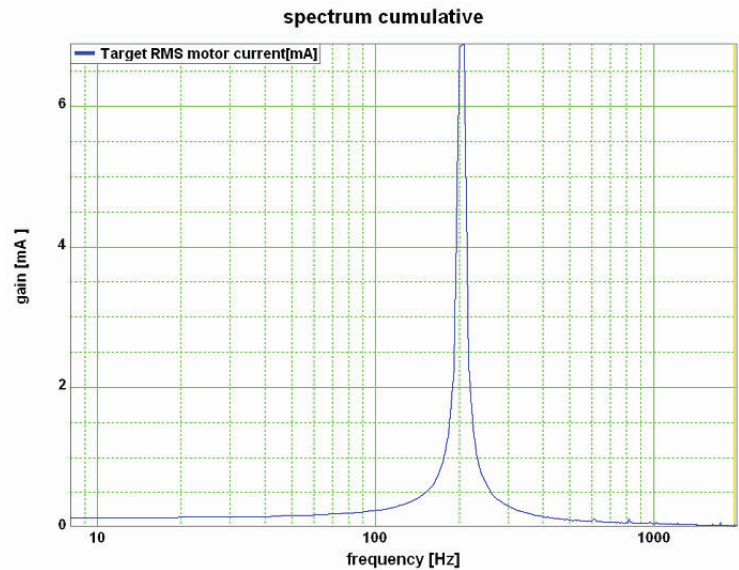

$\Delta f=8\text{Hz} / f_0=204\text{Hz} = 25.5 \cdot \Delta f / \text{frequency}$ does not correspond to the frequency resolution!

The sine frequency has only minimally changed, due to which it does, however, no longer match the frequency resolution ($204\text{Hz}/8\text{Hz}=25.5$) => leak effect

Two consequences are visible:

The spectrum is faded in the ranges at the right and at the left of the sine frequency. In this range, an amplitude is displayed, even though these frequencies are not contained in the real signal.

- ◆ The height of the peak of the sine frequency is reduced, => it seems as if the signal energy is leaking out and distributing over the spectrum. This explains the term leak effect.

Windowing

With the aid of the windowing, leak effects can be avoided. There are many different kinds of windowing, who do all have the same restrictions.

- ◆ windowing reduces the total energy of the analyzed signal, which results in a reduced amplitude of all measured frequencies.
- ◆ Individual frequency peaks do not appear so sharp and narrow as with measurements without windowing.

Sine at 200Hz and 204Hz with Hanning windowing

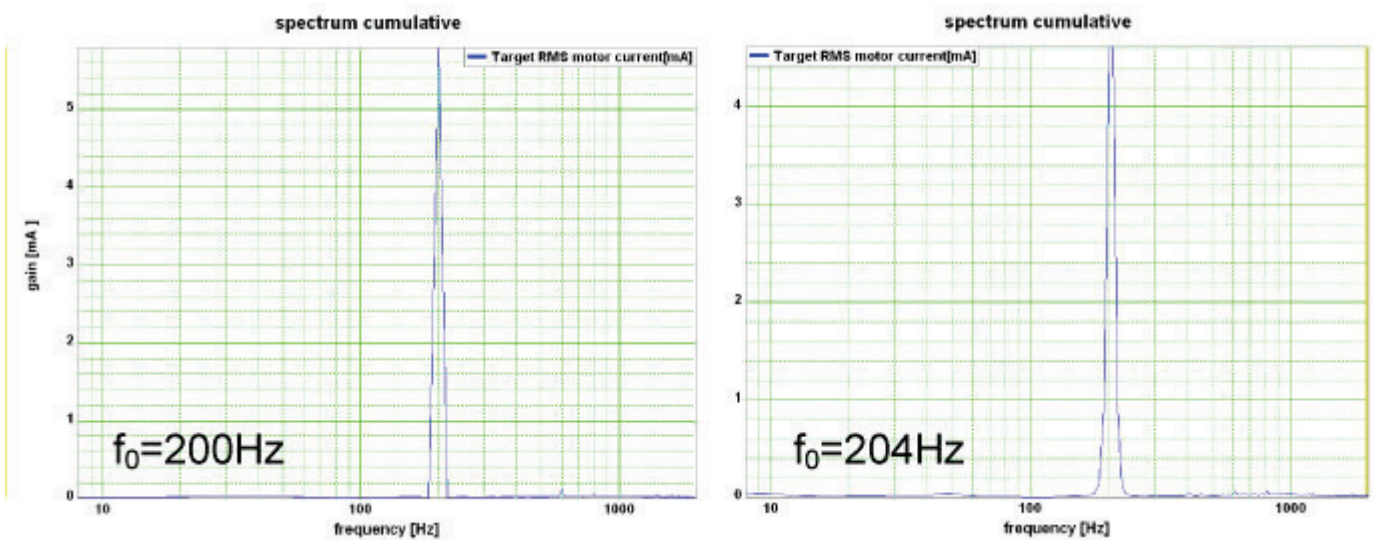

4.4.9.6 Measurement of frequency responses

Please note that you require a license key (see on page 235, see on page 233) for this application!

In this chapter you can read about:

Safety instructions concerning the frequency response measurement.....	242
Functionality of the measurement.....	242
Open/Closed Loop frequency response measurement	244
Excitation Signal.....	245
Non-linearities and their effects.....	245

Safety instructions concerning the frequency response measurement

During the measurement of the frequency response, the control is changed and influenced in multiple ways. You should therefore respect the following notes:

- ◆ During the measurement, the entire system is excited via a broad frequency spectrum. This might damage especially sensitive components (such as lenses) The risk increases with the extent of the excitation. In addition, natural mechanical frequencies may cause an increased excitation of individual components.
- ◆ The measurement of the frequency response can only be made in the setup mode with energized controller.
- ◆ During the current measurement (between start and stop of the measurement), no write flash may be executed.
- ◆ In the event of a break in communication during the measurement, the controller must be switched off and then on again in order to reestablish the original status.
- ◆ Changes of the controller parameters during the measurement are not permitted. Those may be overwritten by standard values when the measurement is terminated.

Functionality of the measurement

Basic structure of a frequency response measurement

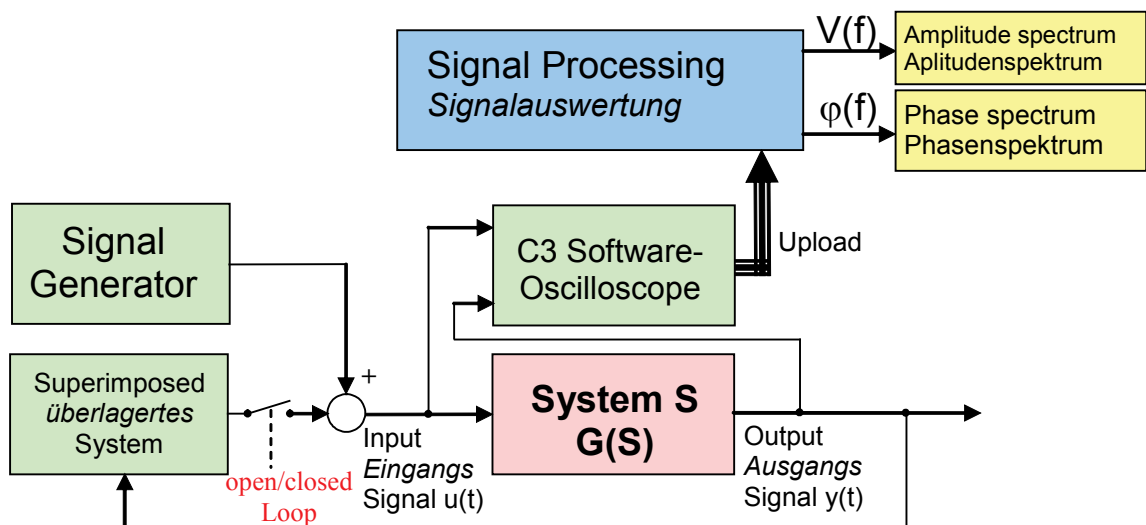

In general, the analysis of the dynamic behavior of a system is made by analyzing the input and output signals.

If you transform the input signal as well as the output signal of a system into the range (Fourier transformation) and then divide the output signal by the input signal, you get the complex frequency response of the system.

$$G(s) = \frac{Y(s)}{U(s)}$$

$$y(t) \xrightarrow{F} Y(s)$$

with $u(t) \xrightarrow{F} U(s)$

A problem are, however, superimposed systems (the control)

Course of the measurement

- ◆ Superimposed controls are switched of (open Loop) or attenuated
- ◆ The excitation signal is injected in front of the system to be measured with the aid of the signal generator. Wait, until the system settled.
- ◆ Execution of the measurement: Registration of input and output signal with the aid of the oscilloscope.
- ◆ Upload of the measurement values from the controller into the PC.
- ◆ Processing of the measurement values into a frequency response
- ◆ If a cumulated measurement is configured: Averaging over several frequency responses.

During cumulated measurement, an average is taken over all measurements in the result memory and the result is then put out.

Open/Closed Loop frequency response measurement

In order to be able to analyze the transmission behavior of subordinate systems (such as for example speed control, current control or mechanical system), the influence of the superposed controls on the measurement must be avoided.

Influence of a superposed system on the frequency response measured

In the simplest case, the superposed controls are switched off completely (Open Loop) This provides the best measurement results due to the elimination of any influence caused by the superposed controls.

This is, however, rarely possible for reasons of safety or feasibility.



Caution!

- ◆ Many systems are not stable without control!
- ◆ Position as well as speed control are switched off during measurement => **no measurement on z-axes!**

If you want to analyze for example the mechanic system of a z-axis, the position control as well as the speed control must remain active.

In systems subject to friction it may be necessary in order to improve the quality of the measurement, to **move the system with a superimposed speed** (see on page 246), which is however only possible with a closed loop measurement.

Influence of an active superposed control on the result of the measurement

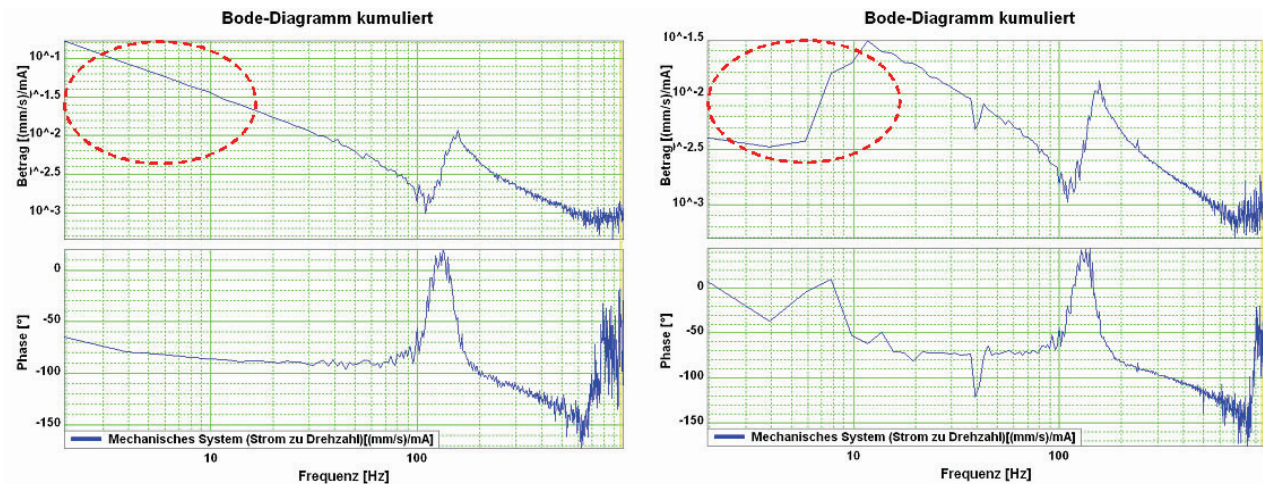

At the left without, at the right with the influence of the superposed control

In order to attenuate the influence of the superposed controls, the controller bandwidth is reduced to such an extent, that their influence on the measurement is negligible.

Excitation Signal

In order to be able to analyze the behavior of the system at individual frequencies, it is necessary that these frequencies can be measured in the input signal as well as in the output signal. For this, a signal generator excites all frequencies to be measured. For this applies, that the signal noise distance of the measurement is the larger, the larger the excitation of the system.
 High noise distance => low influence of disturbances on the measurement.

For this, an excitation signal is injected in front of the system to be measured.

The power (amplitude) of the excitation signal can be set. Start with a small amplitude and increase the amplitude slowly during the current measurement until the result of the measurement shows the desired quality.

Influence of the excitation amplitude on the quality of the measurement results

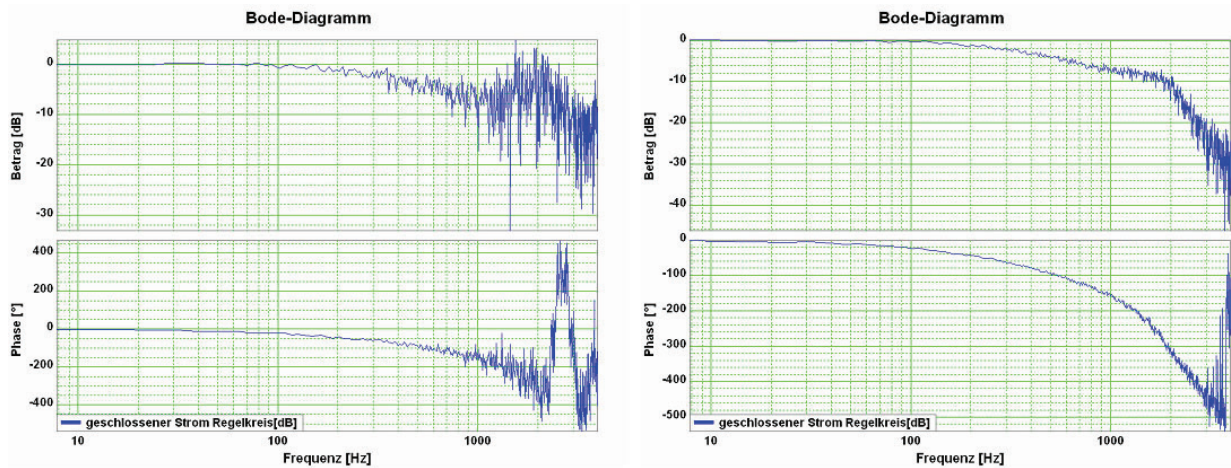

Left: Too small amplitude of the excitation signal (7.3mA)
 Right: Suitable amplitude of the excitation signal (73mA)

In the case of non-linearities in the system, an increase in the excitation may however lead to a **decline of the quality of the measurement** (see on page 245).

Non-linearities and their effects

In this chapter you can read about:

- Attenuation of the excitation amplitude 246
- Shifting the working point into a linear range..... 246

Non-linearities in mechanical systems are for example due to friction, backlash or position-dependent transmissions (cams and crankshaft drives). In general, the frequency response is only defined for linear systems (see 7.2 (see on page 262)). What happens in the frequency range in the event of a non-linear system, is shown below.

Signal amplitude too high => non-linearity in the signal range

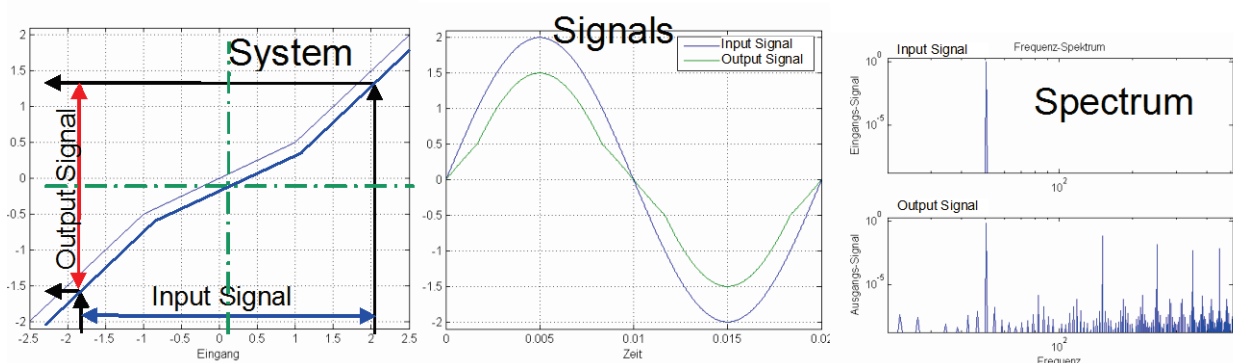

Due to the non-linear transmission behavior of the system, many "new" frequencies were generated in the output signal. In the frequency response, only one change of the frequency present in the input signal can be displayed meaningfully.
 => The frequencies generated in the spectrum of the output signal lead to a deterioration of the measured frequency response.
 There are however two possibilities to make successful measurements of frequency responses in spite of non-linearities present:

Attenuation of the excitation amplitude

Signal amplitude too small => no non-linearity in the signal range

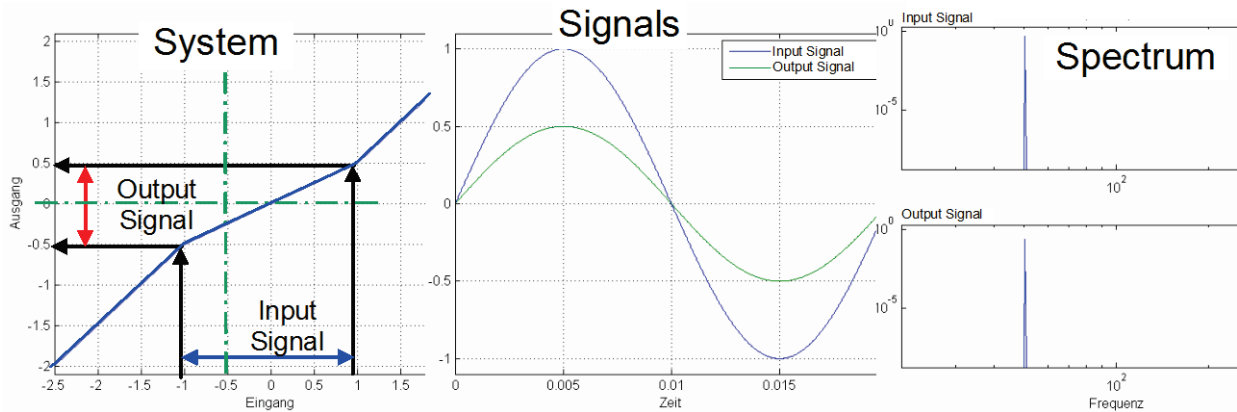

The signal range is reduced so that approximately linear conditions are valid. The results of the measurement will then display the dynamic behavior at the working point.

Example cam drive:

If the drive moves considerably (e.g. 180°) during the measurement, the behavior of the system will change greatly over this range => caused by non-linearities in the signal range.

An inexact measurement is the result.

If the excitation is reduced so that the drive will move only by a few degrees, the behavior of the system at this working point will be approximately constant.

An exact measurement is the result.

Shifting the working point into a linear range

Signal amplitude large with offset => no non-linearity in the signal range

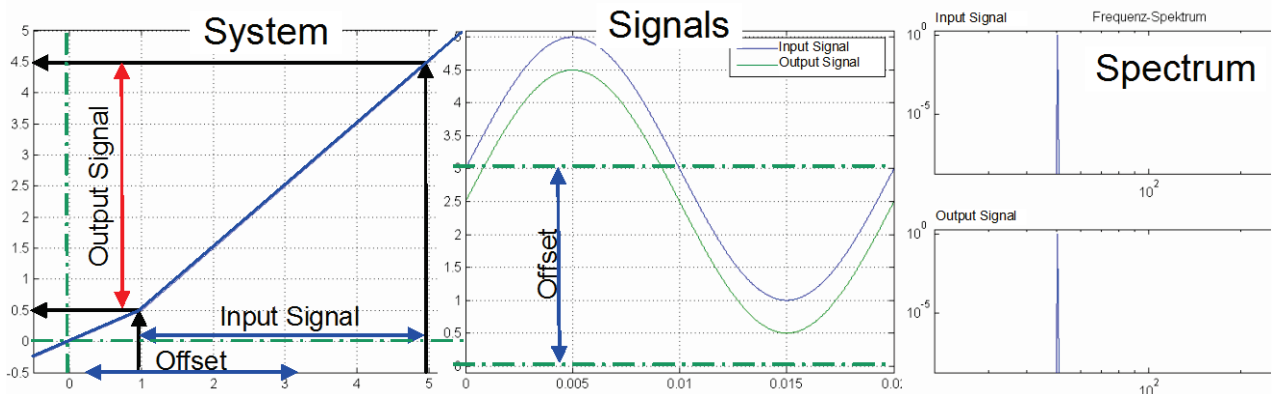

For this, the signal range is shifted so that approximately linear conditions are valid => the results of the measurement show the dynamic behavior at the working point.

Example rubbing caused by friction:

In systems subject to a distinct transition between rubbing caused by friction and sliding friction, the rubbing force will reduce abruptly as soon as the drive is moved ($v > 0$). With a motor at standstill, the excitation signal will cause a multiple passing through the range of rubbing friction during measurement. Due to the non-linearity in the signal range, the resulting measurement will be inexact.

If the drive moves, however, fast enough during the measurement, so that the speed will not become zero during the measurement, the system remains in sliding friction and a precise measurement can be obtained.

Optimal measurement with rubbing friction

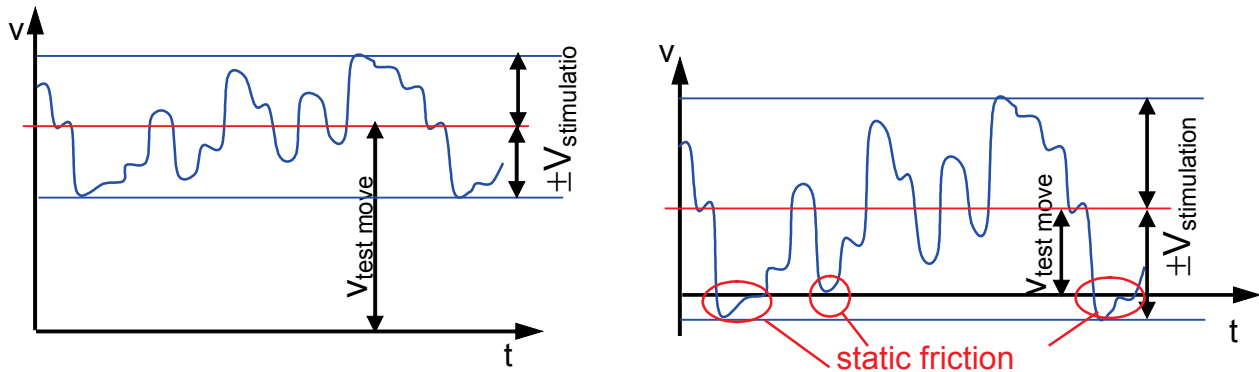

$V_{\text{test move}}$: Speed of the test movement

$V_{\text{stimulation}}$: Speed of the excitation signal

static friction: Static friction

Example backlash: (for example in gearboxes)

Here, non-linearities are caused, if the tooth edges will turn from one side to the other during measurement. The reason for this is a change of the sign of the force transmitted by the gearbox.

In order to avoid this, you can try to transmit a constant torque by keeping a constant speed and to avoid a change of the sign during the measurement by choosing a relatively small excitation amplitude.

4.4.9.7 Overview of the user interface

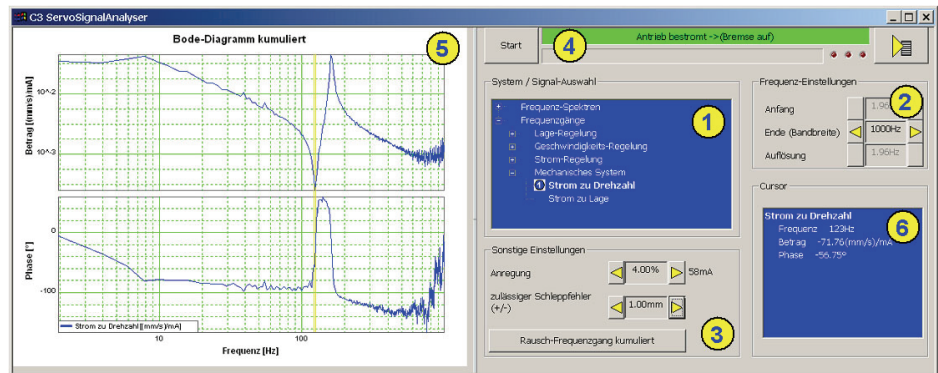

- (1) Selection of the signal or system to be measured (see on page 248)
- (2) Frequency settings (see on page 252)
- (3) Other settings (see on page 254)
- (4) Operating and status field (see on page 257)
- (5) Display of the measurement result (see on page 259)
- (6) Display of the measurement point at the cursor position (see on page 260)

In this chapter you can read about:

Selection of the signal or system to be measured.....	248
Frequency settings	252
Speed control	253
Other settings	254
Operating and status field.....	257
Display of the measurement result.....	259
Display of the measurement point at the cursor position	260

Selection of the signal or system to be measured.

In this chapter you can read about:

Current control.....	248
Mechanical system	249
Position control	250

With the aid of the tree structure, you may select what you want to measure. Here, the selection is made, if a frequency spectrum or a frequency response is to be measured.

The shown structures are simplified in such as all feedbacks are displayed without special transmission behavior. This is surely not the case in reality, serves however a better overview.

Current control

Closed current control

Shows the dynamic behavior of the closed current control.

=> How a signal on the current demand value is transmitted to the current actual value.

(response)

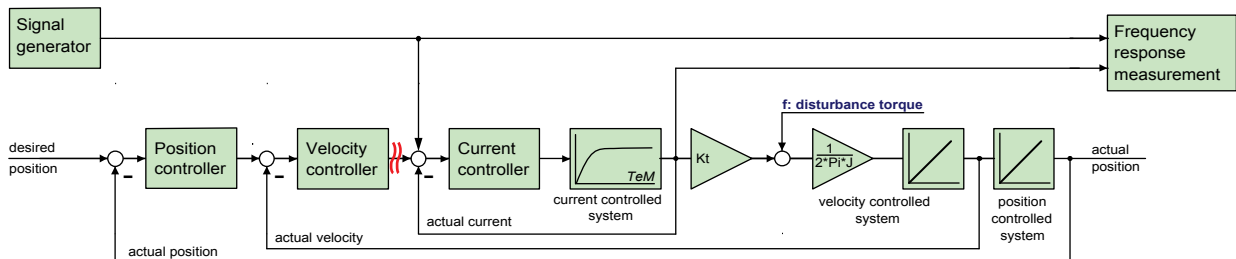

Signal generator	Signal Generator
Position controller	Lageregler
actual position	Lageistwert
desired position	Lagesollwert
Velocity controller	Geschwindigkeitsregler
actual velocity	Geschwindigkeitsistwert
Current controller	Stromregler
actual current	Stromistwert
current controlled system	Stromregelstrecke
f: disturbance torque	Störmoment
velocity controlled system	Geschwindigkeitsregelstrecke
position controlled system	Lageregelstrecke
Frequency response measurement	Frequenzgangmessung

Application:

During the optimization of the current control for verification

◆ for the design of superposed controllers.

Mechanical system

Current to velocity

Shows the dynamic behavior between the measured current actual value and the velocity actual value

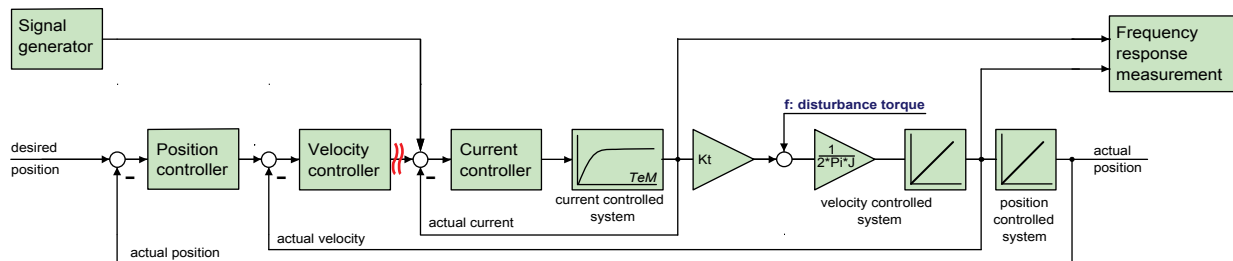

Signal generator	Signal Generator
Position controller	Lageregler
actual position	Lageistwert
desired position	Lagesollwert
Velocity controller	Geschwindigkeitsregler
actual velocity	Geschwindigkeitsistwert
Current controller	Stromregler
actual current	Stromistwert
current controlled system	Stromregelstrecke
f: disturbance torque	Störmoment
velocity controlled system	Geschwindigkeitsregelstrecke
position controlled system	Lageregelstrecke
Frequency response measurement	Frequenzgangmessung

Reflects the transmission behavior between the acceleration at the motor and the acceleration at the load to be moved.

Application:

◆ for the analysis of the dynamic behavior of the mechanic system

Current to position

Shows the dynamic behavior between current actual value and position actual value.

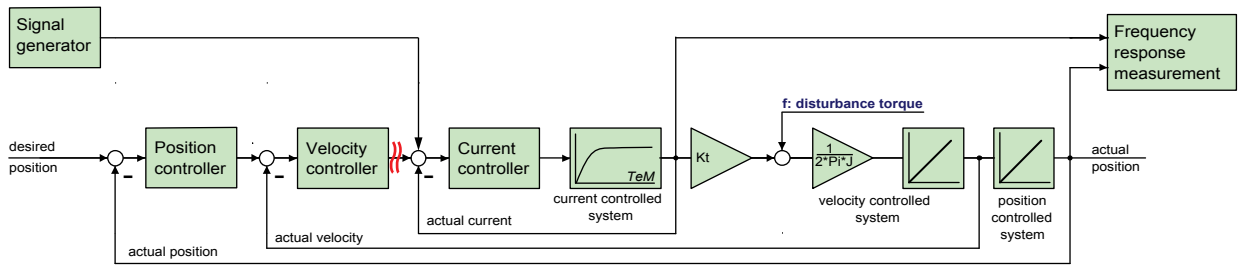

- | | |
|--------------------------------|------------------------------|
| Signal generator | Signal Generator |
| Position controller | Lageregler |
| actual position | Lageistwert |
| desired position | Lagesollwert |
| Velocity controller | Geschwindigkeitsregler |
| actual velocity | Geschwindigkeitsistwert |
| Current controller | Stromregler |
| actual current | Stromistwert |
| current controlled system | Stromregelstrecke |
| f: disturbance torque | Störmoment |
| velocity controlled system | Geschwindigkeitsregelstrecke |
| position controlled system | Lageregelstrecke |
| Frequency response measurement | Frequenzgangmessung |

Application:

- ◆ for the analysis of the dynamic behavior of the mechanic system

Position control

Closed position control

Shows the dynamic behavior of the closed position control.
=> How a signal on the position demand value is transmitted to the position actual value.

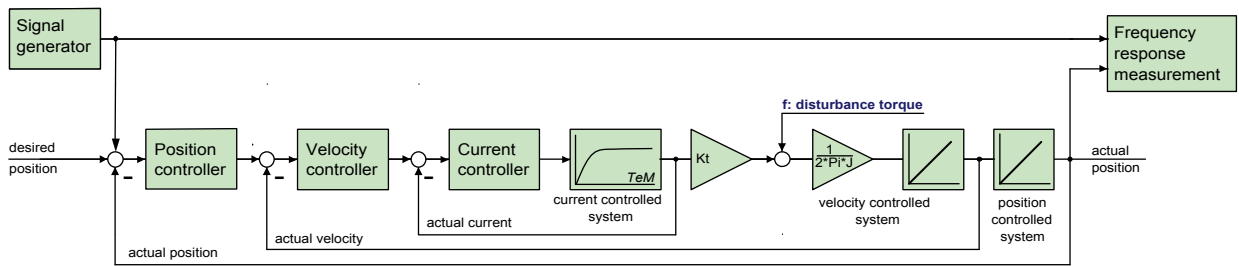

- | | |
|--------------------------------|------------------------------|
| Signal generator | Signal Generator |
| Position controller | Lageregler |
| actual position | Lageistwert |
| desired position | Lagesollwert |
| Velocity controller | Geschwindigkeitsregler |
| actual velocity | Geschwindigkeitsistwert |
| Current controller | Stromregler |
| actual current | Stromistwert |
| current controlled system | Stromregelstrecke |
| f: disturbance torque | Störmoment |
| velocity controlled system | Geschwindigkeitsregelstrecke |
| position controlled system | Lageregelstrecke |
| Frequency response measurement | Frequenzgangmessung |

Application:

For the design of superposed controllers or systems.

- ◆ For the verification of the obtained controller speed during optimization
- ◆ for the revision of the controller design of the position control

open position control

Shows the dynamic behavior of all components in the position control loop, but without closing it.

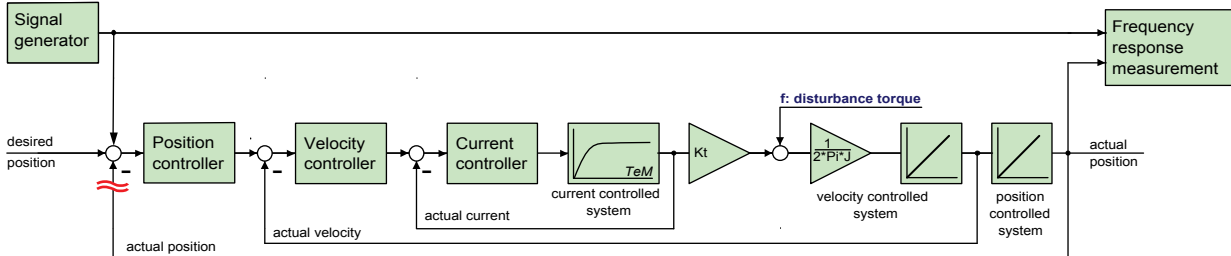

- | | |
|--------------------------------|------------------------------|
| Signal generator | Signal Generator |
| Position controller | Lageregler |
| actual position | Lageistwert |
| desired position | Lagesollwert |
| Velocity controller | Geschwindigkeitsregler |
| actual velocity | Geschwindigkeitsistwert |
| Current controller | Stromregler |
| actual current | Stromistwert |
| current controlled system | Stromregelstrecke |
| f: disturbance torque | Störmoment |
| velocity controlled system | Geschwindigkeitsregelstrecke |
| position controlled system | Lageregelstrecke |
| Frequency response measurement | Frequenzgangmessung |

Application:

- ◆ For the graphic design of the position control.

Compliance of Position control

Shows the dynamic disturbance value behavior of the position control.
 => which dynamic influence does a disturbance torque have on the following error.
 The disturbance torque is injected as disturbance current => this corresponds to the effect of a disturbance torque f

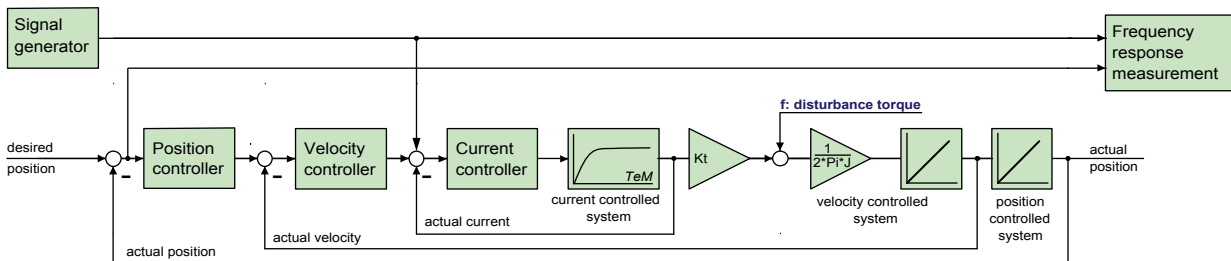

Signal generator	Signal Generator
Position controller	Lageregler
actual position	Lageistwert
desired position	Lagesollwert
Velocity controller	Geschwindigkeitsregler
actual velocity	Geschwindigkeitsistwert
Current controller	Stromregler
actual current	Stromistwert
current controlled system	Stromregelstrecke
f: disturbance torque	Störmoment
velocity controlled system	Geschwindigkeitsregelstrecke
position controlled system	Lageregelstrecke
Frequency response measurement	Frequenzgangmessung

Application:

- ◆ Verification of the dynamic disturbance value behavior of the position control.
- ◆ Which following error generates a sinusoidal disturbance torque / disturbance current with the frequency f_Z ?
- ◆ The frequency response of the compliance corresponds to the disturbance step response in the time range

Frequency settings

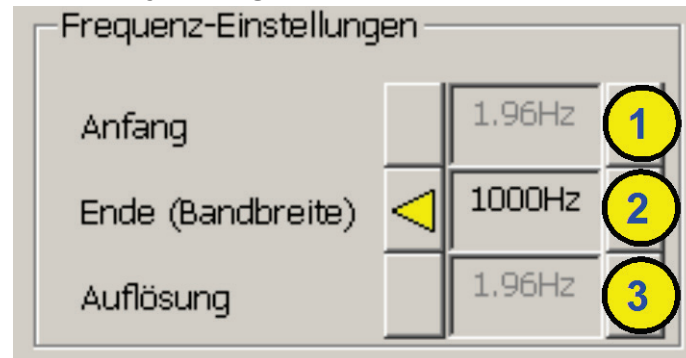

(1) start frequency

- ◆ This is the smallest frequency at which is still measured. During the measurement of frequency spectrum and noise frequency response this results automatically from the bandwidth and is only displayed as an information.

(2) End (bandwidth)

- ◆ This corresponds to the highest frequency which is measured. Start frequency as well as the frequency resolution can be varied with the aid of the bandwidth for frequency spectrum and noise frequency response.

(3) Frequency resolution (see on page 239)

- ◆ During the measurement of frequency spectrum and noise frequency response this results automatically from the bandwidth and is only displayed as an information.

Speed control

Closed velocity control

Shows the dynamic behavior of the closed velocity control.

=> How a signal on the velocity demand value is transmitted to the velocity actual value.

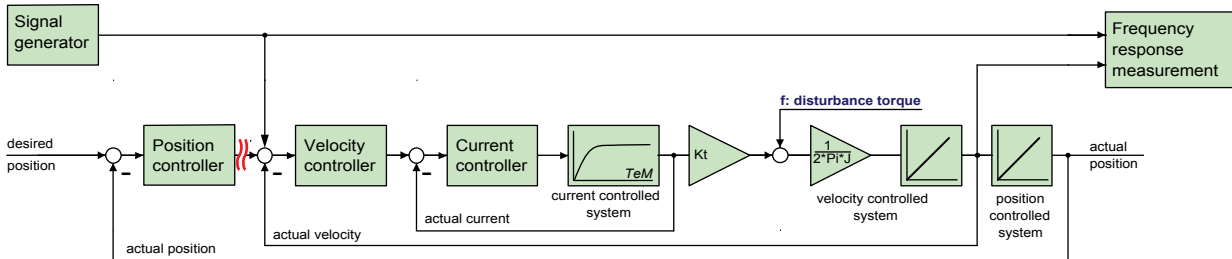

- | | |
|--------------------------------|------------------------------|
| Signal generator | Signal Generator |
| Position controller | Lageregler |
| actual position | Lageistwert |
| desired position | Lagesollwert |
| Velocity controller | Geschwindigkeitsregler |
| actual velocity | Geschwindigkeitsistwert |
| Current controller | Stromregler |
| actual current | Stromistwert |
| current controlled system | Stromregelstrecke |
| f: disturbance torque | Störmoment |
| velocity controlled system | Geschwindigkeitsregelstrecke |
| position controlled system | Lageregelstrecke |
| Frequency response measurement | Frequenzgangmessung |

Application:

- ◆ During the optimization of the velocity control for verification
- ◆ For the design of superposed controllers.

Open velocity control

Shows the dynamic behavior of all components in the velocity control loop, but without closing it.

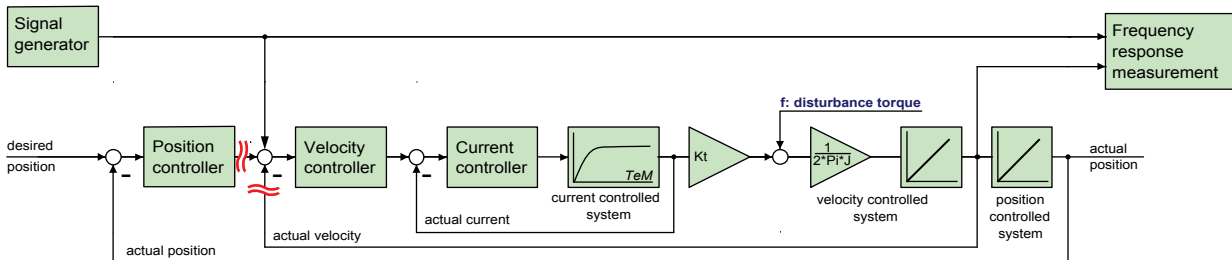

- | | |
|--------------------------------|------------------------------|
| Signal generator | Signal Generator |
| Position controller | Lageregler |
| actual position | Lageistwert |
| desired position | Lagesollwert |
| Velocity controller | Geschwindigkeitsregler |
| actual velocity | Geschwindigkeitsistwert |
| Current controller | Stromregler |
| actual current | Stromistwert |
| current controlled system | Stromregelstrecke |
| f: disturbance torque | Störmoment |
| velocity controlled system | Geschwindigkeitsregelstrecke |
| position controlled system | Lageregelstrecke |
| Frequency response measurement | Frequenzgangmessung |

Application:

For the graphic design of the velocity control.

Compliance of velocity control

Shows the dynamic disturbance value behavior of the velocity control.

=> which dynamic influence does a disturbance torque have on the control deviation of the velocity control.

The disturbance torque is injected as disturbance current => this corresponds to the effect of a disturbance torque f

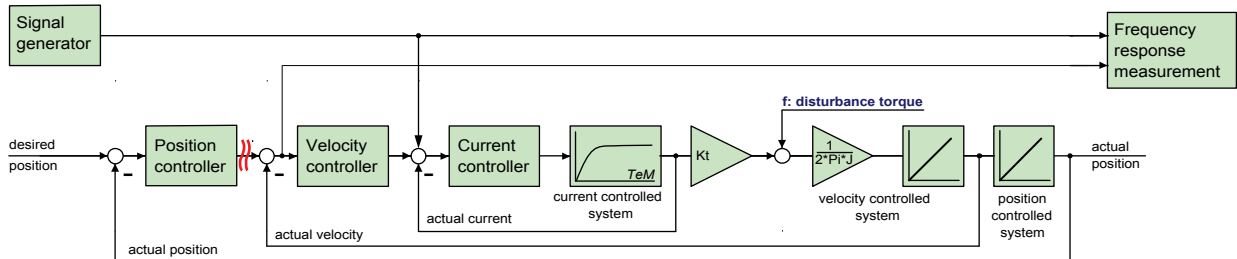

Signal generator	Signal Generator
Position controller	Lageregler
actual position	Lageistwert
desired position	Lagesollwert
Velocity controller	Geschwindigkeitsregler
actual velocity	Geschwindigkeitsistwert
Current controller	Stromregler
actual current	Stromistwert
current controlled system	Stromregelstrecke
f: disturbance torque	Störmoment
velocity controlled system	Geschwindigkeitsregelstrecke
position controlled system	Lageregelstrecke
Frequency response measurement	Frequenzgangmessung

Application:

- ◆ Verification of the disturbance value behavior of the velocity control
- ◆ Which velocity deviation generates a sinusoidal disturbance torque / disturbance current with the frequency f_Z ?
- ◆ The frequency response of the compliance corresponds to the disturbance step response in the time range

Other settings

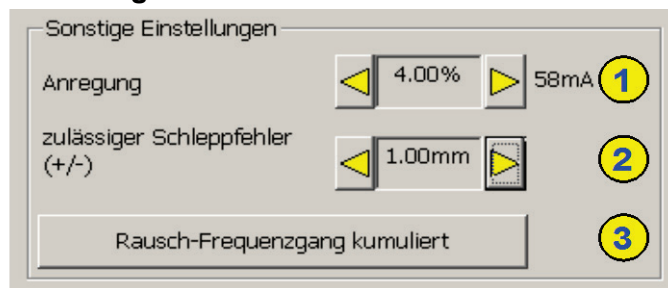

(1) Excitation

Serves to set the excitation signal of the frequency response measurement.

(2) Permissible following error (only for frequency response measurement)

The resulting following error is increased by the injection of the excitation signal during the frequency response measurement. In order to allow for this, the permissible following error window can be enlarged so that the measurement can be made. After the end of the measurement, this is reset to the original value.

(3) Selection of the kind of analysis of the measurement results

Depending on the fact whether frequency spectra or frequency responses are measured, the following types of analyses are available:

For frequency spectra:

- ◆ (a) Spectrum
- ◆ (b) Spectrum cumulated
- ◆ (c) cascade diagram

For frequency responses:

- ◆ (d) noise frequency response
- ◆ (e) noise frequency response cumulated

Non cumulated measurement (a & d)

The measured data are displayed directly. This is especially suitable if you wish to analyze the effects of changes on the measurement results directly and promptly. The disadvantage is however a smaller noise distance (quality) and an increased sensitiveness of the measurement towards unique disturbances.

Cumulated measurement (b & e)

An average is taken from all measurements in the result memory. This reduces the influence of random signals and disturbances extremely (improvement of the quality). The number of measurements from which the average is taken, is set with the **Size of the result memory** (see on page 257).

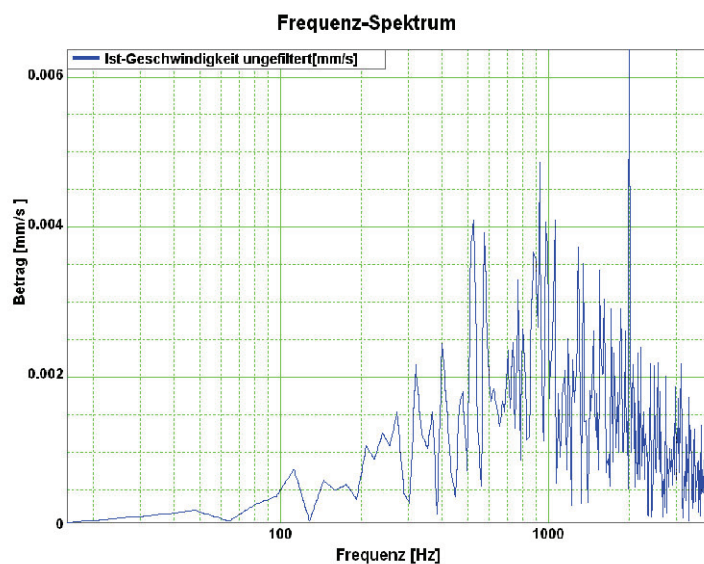
Comparison of two frequency spectra without and with cumulation

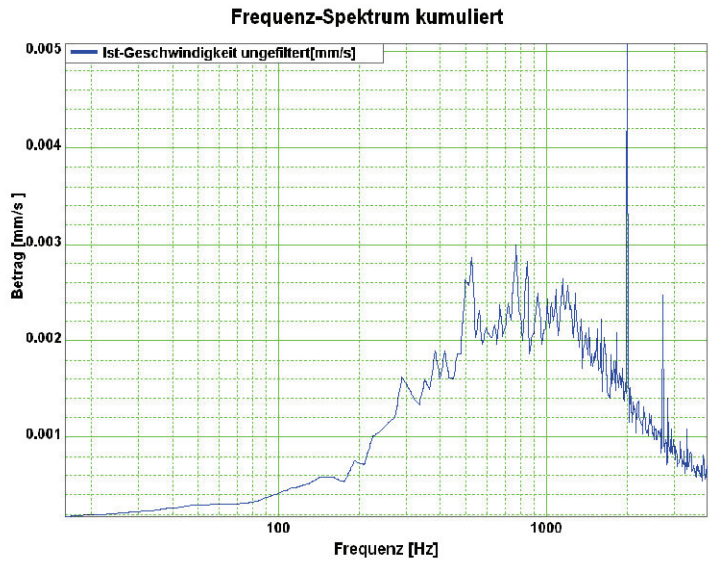

Cascade diagram (c)

Frequency spectra are displayed subject to time. The information on the value of the signal is color-coded.

Cascade diagrams of the velocity signal during an acceleration process

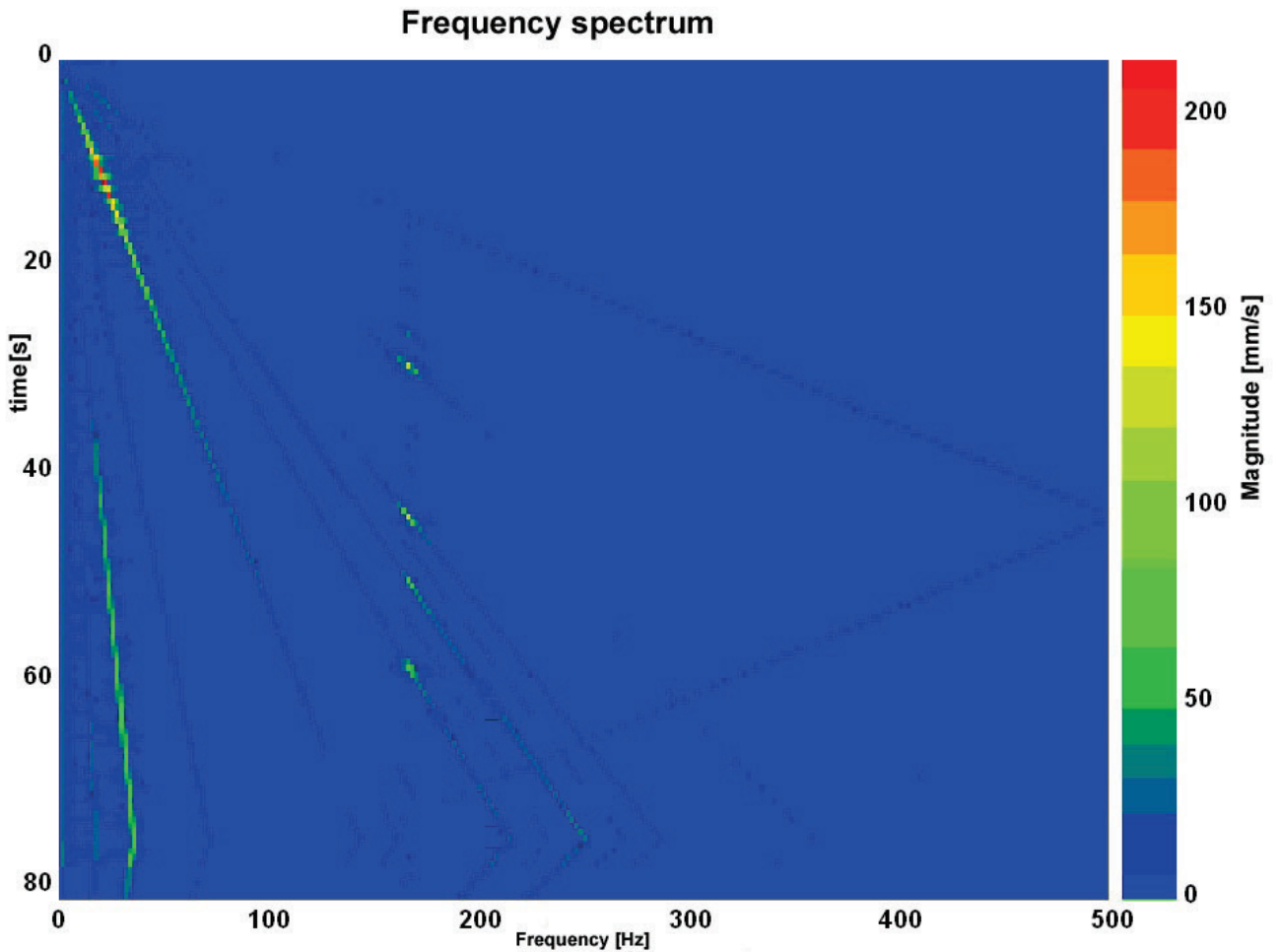

This kind of display is suitable for the analysis of temporal changes in the measured spectrum.

Operating and status field

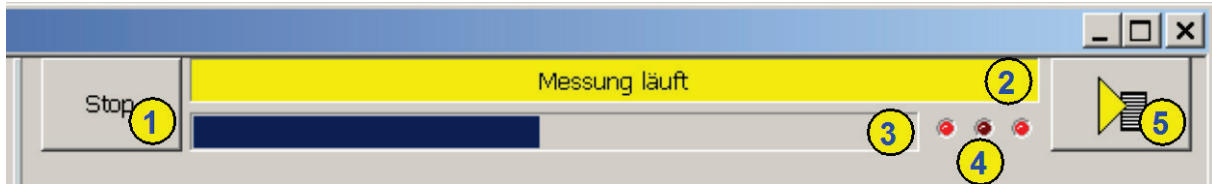

(1) Start and Stop of the measurement

(2) Status display

Current status of the measurement or of the controller (if no measurement is taking place).

(3) Progress of the registration of the signals in the controller

The time of registration of the signals in the controller itself can, depending on the bandwidth and the kind of measurement, take up to one minute.

(4) status of the activity of the different partitions of the measurement

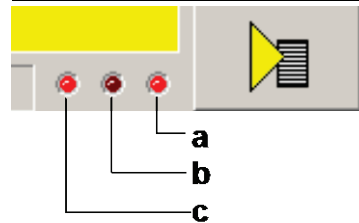

a: Registration of the measurement in the controller

b: Upload of the measurement from the controller to the PC

c: Processing the measurement in the PC

(5) Different settings and options

Functions available in a pull-down menu:

Open superimposed control loops (see on page 244)

accept load force

This serves, when opening the velocity controller, to accept the load which the controller has provided at the time of switching off => a z-axis does not drop down abruptly.

Measurement synchronous to the test movement

If this option is selected, it is ensured during the measurement, that the sampling does not take place in the turning point during a movement.

Unless frequencies are generated due to the deceleration/acceleration of the drive, which influence the measurement.

Result memory

In the result memory, the results of the N last measurements are kept.

This is important for the display of the cumulated measurement and for the cascade diagram. The larger the memory, the "older" the results still used. When the contents is deleted, all old measurements are discarded and do no longer influence the new results.

Windowing (see on page 240)

Here you can select different windowing modes for the measurement of frequency spectra. As default, no window is used.

Save measure to file

The currently displayed measurement result is stored and can be uploaded later into the ServoSignalAnalyzer. This does, however, not apply to the cascade diagram display.

Open measure from file

Here you can reload the measurements memorized before. You have the possibility to load up to four measurements subsequently and display them together in a graphic display.

Copy measurement to clipboard as graphic display.

The currently displayed measurement result is copied as pixel graphic (e.g. BMP) to the clipboard.

Display of the measurement result

Frequency spectra

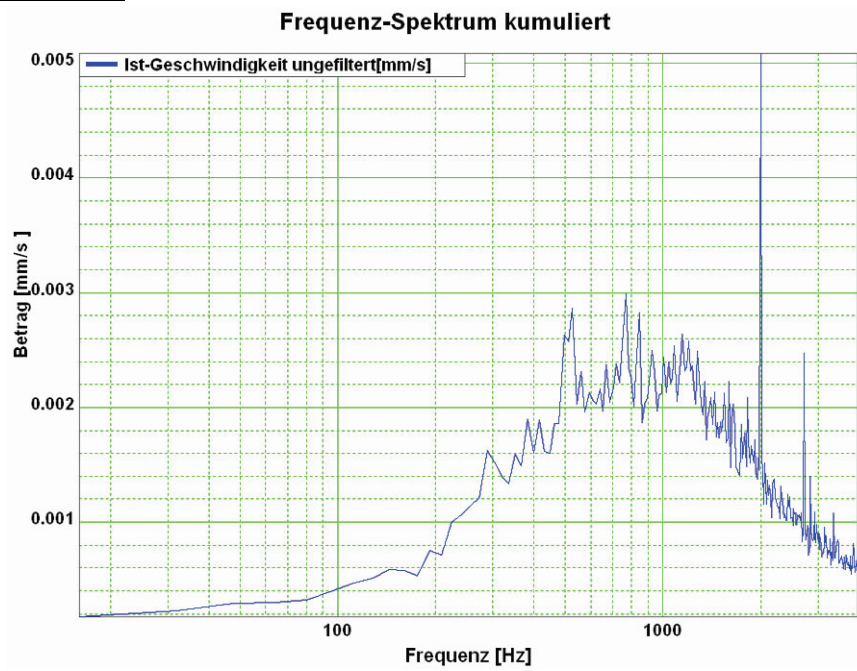

Bode diagrams: Value and phase

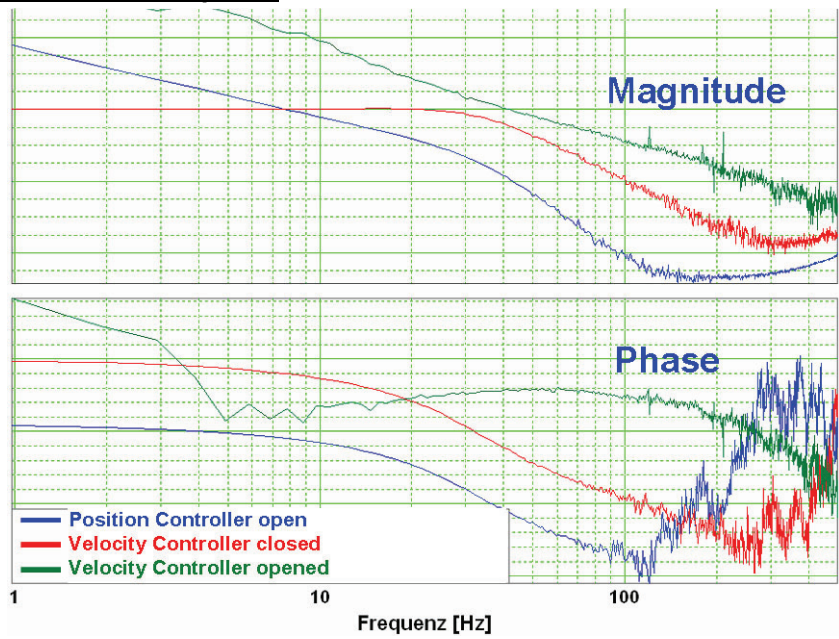

By clicking with the left mouse button on the legend, this can be shifted by 90°. By clicking on the color bar, the color of the respective graph can be modified.

Cascade diagrams

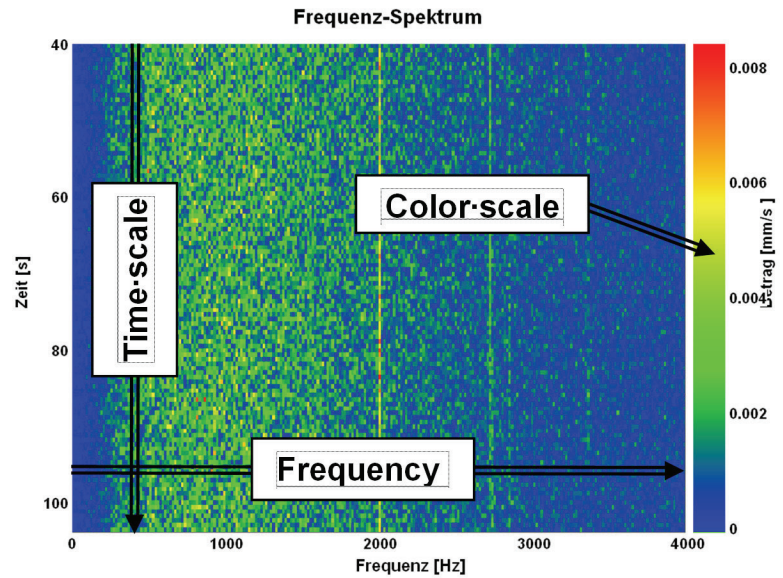

By clicking with the left mouse button on the color scale, you can change between autoscale mode and fixscale mode.

AutoScaleMode:

In this mode, the scaling of the color scale is adapted automatically so that all values can be displayed.

FixScaleMode:

Here, the scaling is fixed.

=> If, for instance, a considerably higher value than before is to be displayed, it is simply displayed like the former maximum (red).

Display of the measurement point at the cursor position

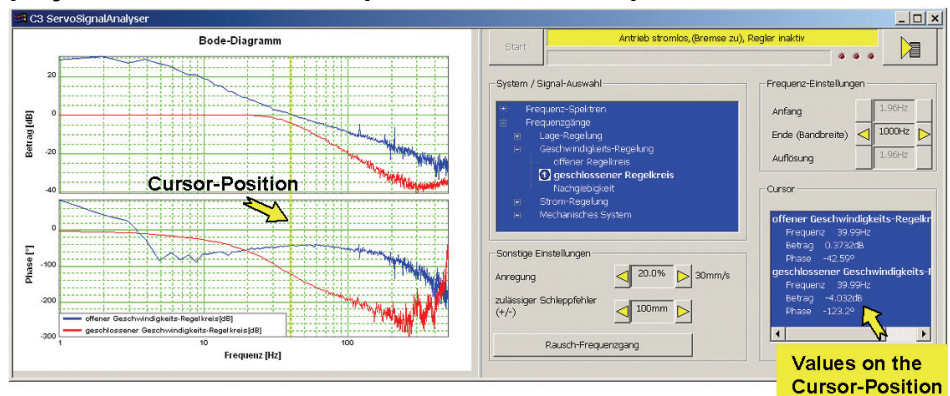

The cursor is set by clicking on the left mouse button. All measurement data of the selected cursor position (frequency) are displayed in the "cursor" operating field.

4.4.9.8 Basics of frequency response measurement

In the drive and control technology, the display of signals and systems in the frequency range is often the best possibility to solve different tasks.

In this chapter you can read about:

Distinction between signals and systems	261
Linear Systems (LTI System).....	262
Mechanical system	263
Resonance points and their causes	264

Distinction between signals and systems

Defined objects and their interactions that can be combined to a whole by a plausible distinction from their environment (i.e. the complex reality) are called a system.

Example electric motor

This consists of a multitude of different components, but the function and the behavior of a motor can be described as a whole without describing each individual component and their interactions separately.

If the motor is energized, it will generate a torque at the motor shaft.

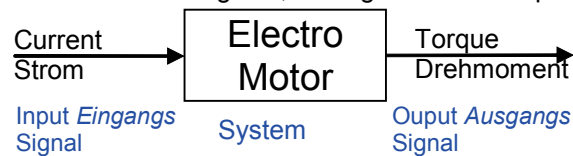

Current is therefore a signal, which causes at the input of the system motor a change of its torque output signal.

In order to register and process such signals in the controller, they are digitized and read in with the so-called scanning frequency (f_A). Thus the physical signal was converted into a finite sequence of numbers, which can be processed in the controller.

Linear Systems (LTI System)

Further explanations are based on the concept of so-called linear systems. This means that doubling the input value means that the portion of the output value influenced by it is also doubled. This, for instance, is not the case in the event of influence due to limitations, friction and backlash.

=> those are called non-linear systems, which can not be analyzed with the methods described here (or only with difficulties).

One of the most important properties of linear systems is that a sine signal, which is put through a linear system, is still a sine signal at the output, which differs from the input signal only in value and phase.

When a signal passes a LTI system, no new frequencies are generated.

Input and output signals of a linear system

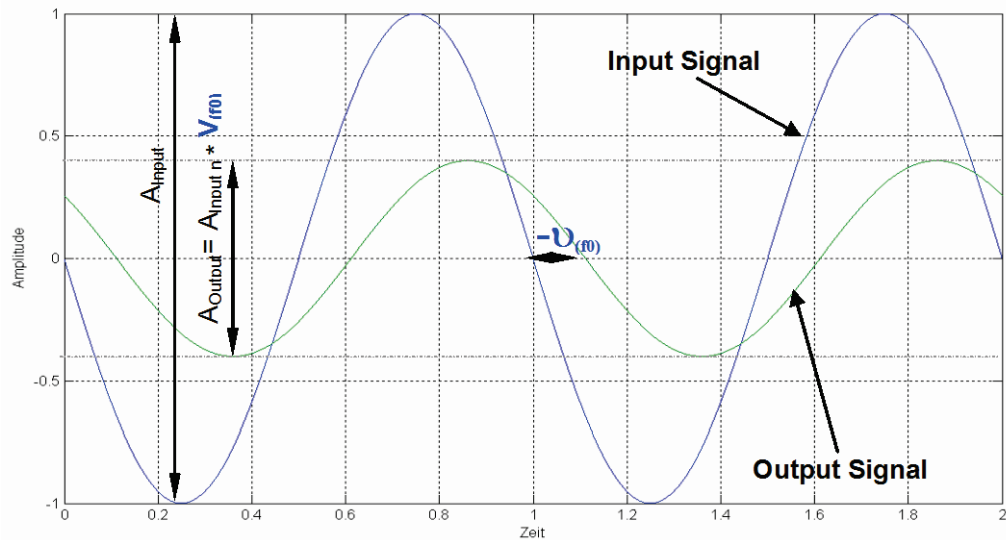

If you know the value ($V(f_0)$) as well as the phase position ($u(f_0)$) for all frequencies, the LTI system is completely defined.

Such a graph of value and phase position in dependence of the frequency, is called frequency response or bode diagram.

=> only LTI systems can be analyzed with the aid of frequency responses.

Frequency response / bode diagram

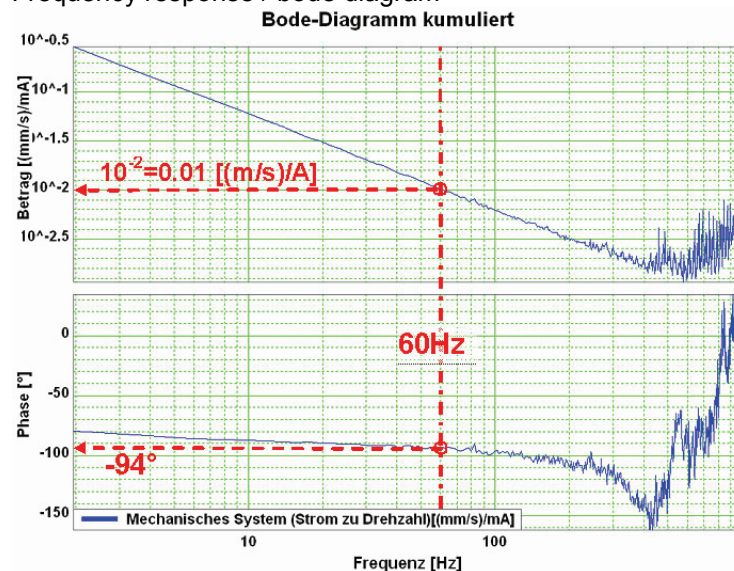

The frequency response shows the amplification (value) and the phase shift (phase), which a signal is submitted to when passing through a system.

The displayed bode diagram allows the following conclusions:

If a sine with 60Hz and an amplitude of 1A is present at the input, a sine delayed by 94° and an amplitude of 0.01m/s will result at the output.

Mechanical system

Frequency response of a mechanic system: Current - velocity of a motor

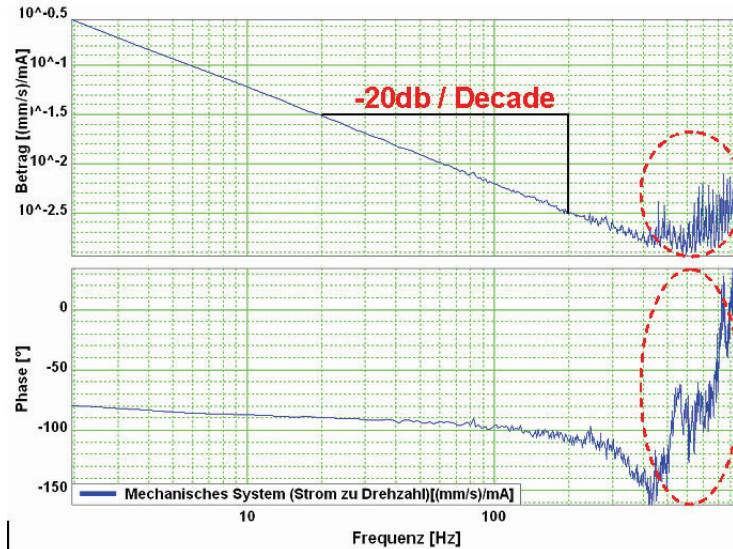

The outlined course at the end of the measurement range does not permit statements on the system measured due to disturbances. Due to the attenuation of the signals increasing with the frequency, the sensitiveness of the measurement to disturbances (signal to noise ratio) increases with a rising frequency. The value as well as the phase response of the displayed frequency response are "disturbed" at the same intensity, this shows, that disturbances are the reason.

The value response consists basically of a straight, which declines with a slope of -20dB/decade (-20dB/decade => per tenfold increase of the frequency, the value decreases also by factor ten.

The phase response remains however almost constantly at -90° over a relatively large range.

In control technology, this is called integrating behavior (I-behavior).

the I-behavior can be explained as follows.

The measured current is proportional to the motor force and thus also to the acceleration of the driven mass. As the velocity is calculated from the integrated acceleration, the measured system looks as follows:

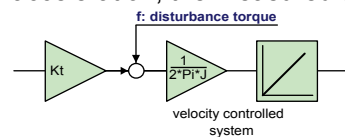

Input value is the current actual value, output value is the velocity actual value

Resonance points and their causes

In this chapter you can read about:

Rotary two mass system.....264
 Linear two mass system265
 Toothed belt drive as two mass system265

Mechanical system with a resonance point

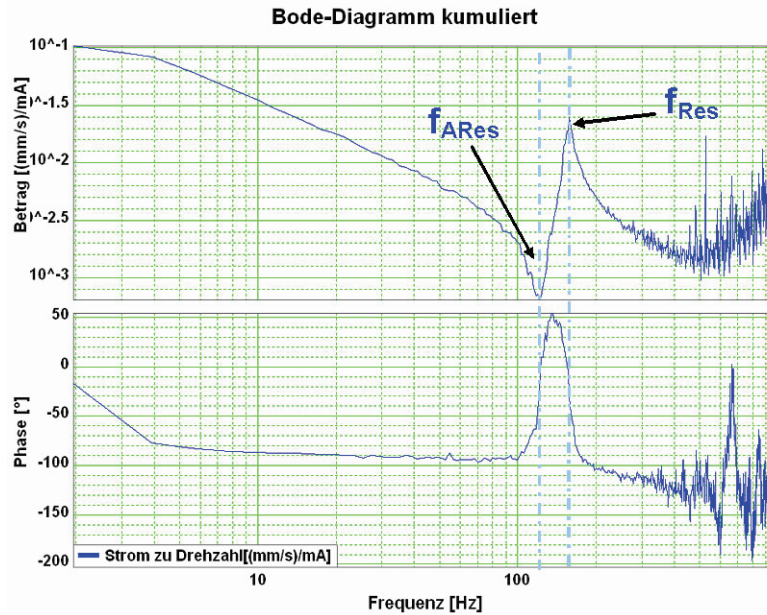

fARes: Anti resonance frequency

fRes: Resonance frequency

The displayed change of the frequency response (resonance point), has its cause in a so-called two mass system (caused by the elastic coupling of two masses).

Hint As, upon closer examination, each mechanic coupling shows a certain elasticity, it is no the question if there is a resonance point, but at which frequency it is and how well it is attenuated.

Rotary two mass system

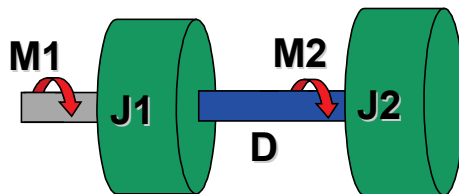

The shown system corresponds for instance to a motor with a flywheel coupled via a shaft. Hereby J1 corresponds to the motor moment of inertia and J2 to the moment of inertia of the flywheel.

Calculation of the resonance frequencies in the rotary system with a hollow shaft as elastic coupling element

$$D = \int_{r_I}^{r_A} \frac{2 \cdot \pi \cdot G}{l} \cdot r^3 \cdot dr = \frac{G \cdot \pi \cdot (r_A^4 - r_I^4)}{2 \cdot l}$$

$$f_{ARes} = \frac{1}{2 \cdot \pi} \cdot \sqrt{\frac{D}{J_2}} \qquad f_{Res} = \frac{1}{2 \cdot \pi} \cdot \sqrt{D \cdot \left(\frac{1}{J_1} + \frac{1}{J_2} \right)}$$

G	Shear modulus of the material used [N/m ²] (e.g. approx. 80750N/mm ² for steel)
D	Torsional rigidity in [m/rad]
rA	Outer radius of the hollow shaft
rl	Inner radius of the hollow shaft
l	Length of the hollow shaft

Linear two mass system

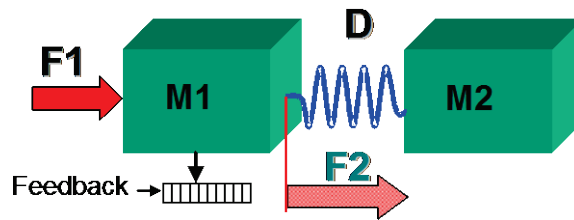

Resonance frequencies in the linear system

$$f_{ARes} = \frac{1}{2 \cdot \pi} \cdot \sqrt{\frac{D}{m_2}}$$

$$f_{Res} = \frac{1}{2 \cdot \pi} \cdot \sqrt{D \cdot \left(\frac{1}{m_1} + \frac{1}{m_2} \right)}$$

D	Rigidity in [N/m]
m1	e.g. motor mass
m2	e.g. load mass

Toothed belt drive as two mass system

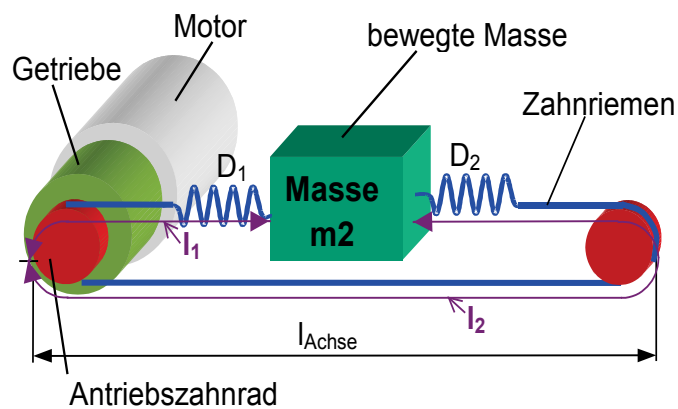

In toothed belt drives, the toothed belt is the elastic coupling element. Its rigidity depends directly on the lengths l_1 and l_2 and changes in dependence of the position of the moved mass.

$$D_{spez} = \frac{F_{max}}{0,004}; \quad l_2 = 2 \cdot l_{Achse} - l_1$$

$$D_1 = \frac{D_{spez}}{l_1}; \quad D_2 = \frac{D_{spez}}{l_2}; \quad D = D_1 + D_2 = \frac{2 \cdot D_{spez}}{l_1 \cdot \left(2 - \frac{l_1}{l_{Achse}}\right)}$$

$$f_{ARes} = \frac{1}{2\pi} \cdot \sqrt{\frac{D}{m_2}} \quad f_{Res} = \frac{1}{2\pi} \cdot \sqrt{D \cdot \left(\frac{1}{m_2} + \frac{(r_{Zahnrad})^2}{J_1 \cdot (i_{Getriebe})^2} \right)}$$

D	Total spring constant of the toothed belt drive
Dspez	Specific spring constant of the toothed belt used
D1	Spring rate of the belt length l_1
D2	Spring rate of the belt length l_2
iGearbox	Transmission ratio of the gearbox
lAxis	Length of the axis
J1	Moment of inertia of motor and gearbox
m2	translatory moved mass
rToothed wheel	Radius of the drive pinion

Here you can find examples as a movie in the help file.

4.4.10. ProfileViewer for the optimization of the motion profile

In this chapter you can read about:

- Mode 1: Time and maximum values are deduced from Compax3 input values266
- Mode 2: Compax3 input values are deduced from times and maximum values.....267

You will find the ProfilViewer in the Compax3 ServoManager under the "Tools" Menu:

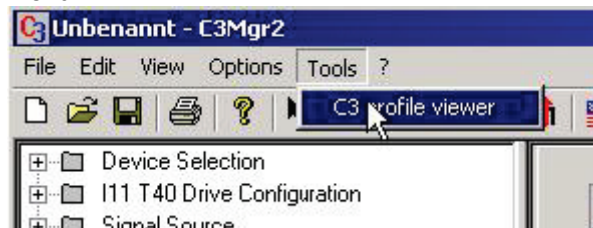

4.4.10.1 Mode 1: Time and maximum values are deduced from Compax3 input values

- ◆ The motion profile is calculated from Position, Speed, Acceleration, Deceleration, Acceleration Jerk and Deceleration Jerk
- ◆ As a result you will get, besides a graphical display, the following characteristic values of the profile:
 - ◆ Times for the acceleration, deceleration and constant phase
 - ◆ Maximum values for acceleration, deceleration and speed

4.4.10.2 Mode 2: Compax3 input values are deduced from times and maximum values

- ◆ A jerk-limited motion profile is calculated from the positioning time and the maximum speed / acceleration
- ◆ As a result you will get, besides a graphical display, the following characteristic values of the profile:
 - ◆ the parameters Position, Speed, Acceleration, Deceleration, Acceleration Jerk and Deceleration Jerk
 - ◆ Times for the acceleration, deceleration and constant phase
 - ◆ Maximum values for acceleration, deceleration and speed

Set deceleration and acceleration phase

The profile can be defined more exactly by entering the segmentation into deceleration and acceleration phase.

When setting 50% and 50%, a symmetrical design will result, the values for triangular operation are calculated, which is limited by the maximum speed.

The total of the percentage values may not exceed 100.

The percentage entries refer to the total positioning time.

Example:

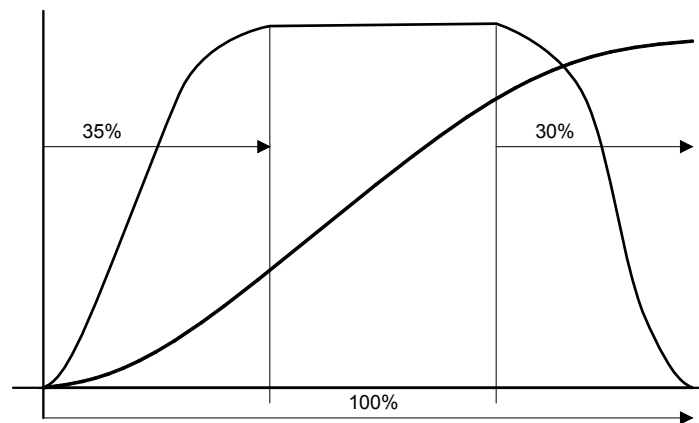

4.4.11. Turning the motor holding brake on and off

Compax3 controls the holding brake of the motor and the power output stage. The time behavior can be set.

Application:

With an axis that is subject to momentum when it is halted (e. g. for a z-axis) the drive can be switched on and off such that no movement of the load takes place. The drive thereby remains energized during the holding brake response time. This is adjustable.

The power output stage current is de-energized by:

- ◆ Error or
- ◆ I2=X12/8="0V"

Thereafter the motor is braked to zero rotation speed on the set ramp. When zero speed is reached, the motor is de-energized with the delay "brake closing delay time".

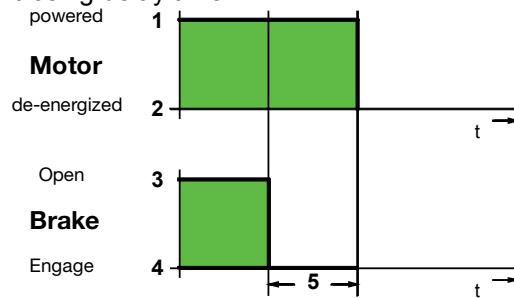

- 1: Motor powered
- 2: Motor de-energized
- 3: Open brake
- 4: Engage the brake
- 5: Brake closing delay time

The power output stage is enabled by:

- ◆ Quit (after an error)
- ◆ I2=X12/8 = 24V

The motor is energized with the delay "delay time for brake release":

brake closing delay time > 0 **brake closing delay time < 0**

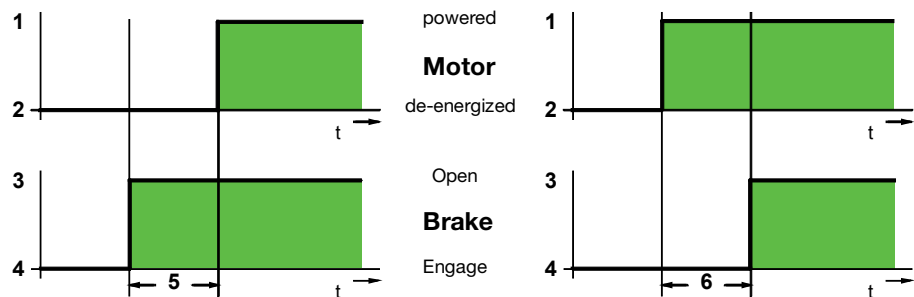

- 1: Motor powered
 - 2: Motor de-energized
 - 3: Open brake
 - 4: Engage the brake
 - 5: Delay time for brake release (positive value)
 - 6: Delay time for brake release (negative value)
- A negative value (6) can be used to energize the motor and then to release the brake after the given time.

5. Control via RS232 / RS485 / USB

Description of the **interface protocol** (see on page 287).

In this chapter you can read about:

Status diagram	270
I/O assignment, control word and status word with control via COM port	271
Examples include: Control via COM port	275
Layout of the set table	277
Compax3 communication variants	278
COM port protocol	287
Remote diagnosis via Modem.....	292

5.1 Status diagram

Status diagram for control via RS232 / RS485

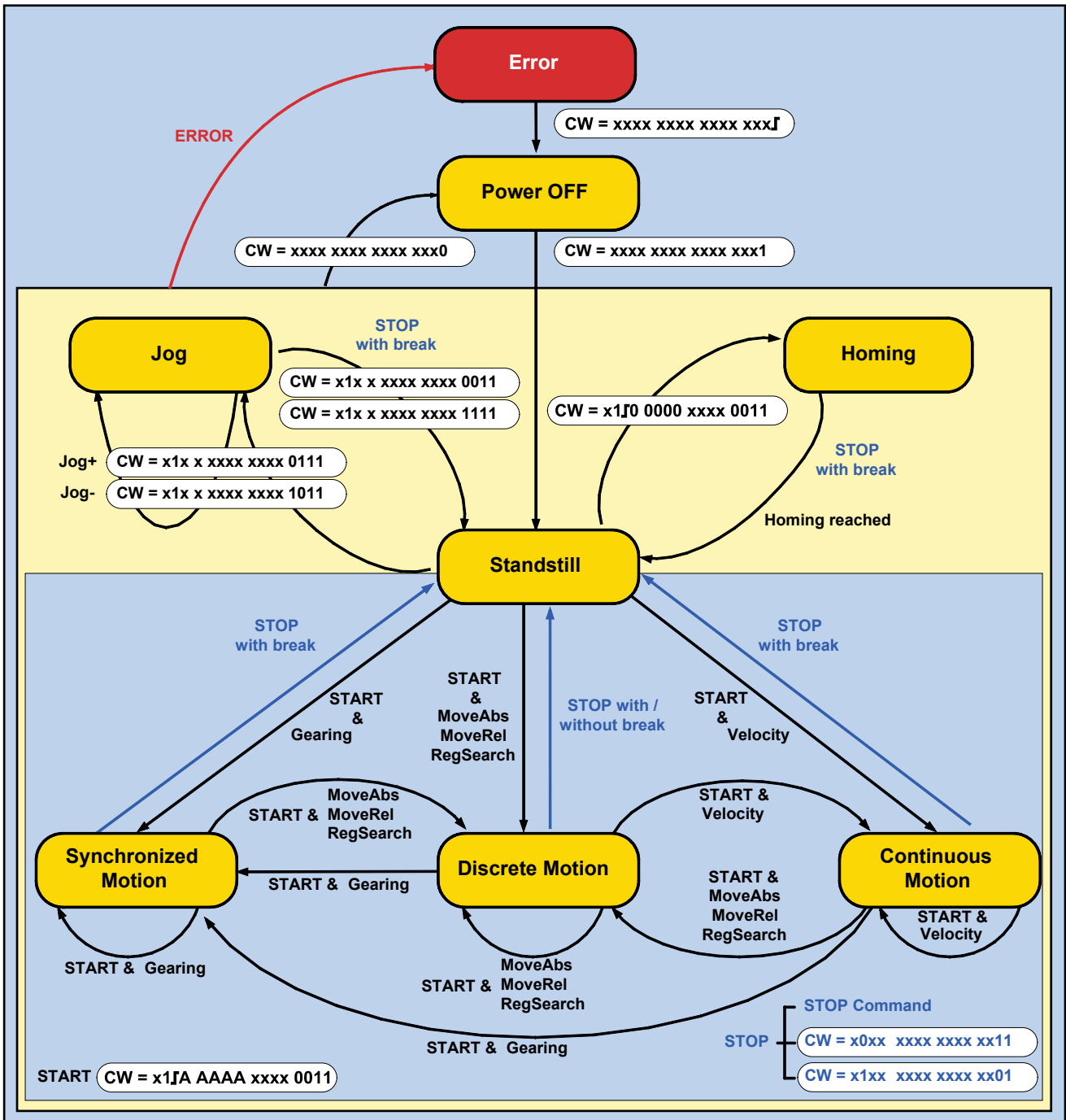

In the "Homing" and "Jog" states, no stop set (STOP command) is possible.
 CW: Control word; bit counting method: Bit 0 on the right side
 x: x: status of the respective bits without meaning
 A: Set address
 otherwise status 0, 1 or positive edge

Status values:	Description
ERROR	Error, drive currentless
Power OFF	Drive currentless and ready to operate
Jog	Manual operation; Manual+, Manual- possible
Homing	Machine zero run, status is exited automatically after the position 0 has been approached
Standstill	Drive stationary with current with setpoint value = 0
Synchronized Motion	Gearing motion set active
Discrete Motion	Positioning mode
Continuous Motion	Velocity motion set active

Permitted transitions: Please find the possible transitions between states resp. the different motion functions in the status diagram:

Examples include:

- ◆ In the "discrete motion" status (drive executes a motion function) the motion functions MoveAbs, MoveRel, MoveStart, Velocity and Stop are possible with dynamic transition.
- ◆ In the Continuous Motion status, only a stop with termination (Stop with break) is possible.

5.2 I/O assignment, control word and status word with control via COM port

5.2.1 I/O Assignment

- ◆ For intra-device inputs I0 .. I3 as well as the outputs O0 ... O3 you can choose between fixed or free assignment (see below).
- ◆ Control via RS232 / RS485 does not require an M option (M10 / M12).
- ◆ If an M option is available, 12 inputs/outputs (ports) are freely assignable. These can be configured as inputs or outputs by groups of four and be activated or read via Object 121.2 and Object 133.3.
- ◆ The signal inputs I4 ... I7 are fixedly assigned
If the respective functions are not needed, these inputs can also be used for control.
I5 and I6 can, for example, be used as free inputs if the limit switch function is deactivated.

Assignment of the intra-device inputs and outputs

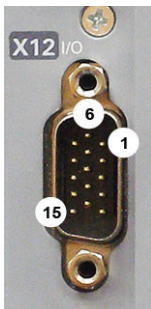

Pin X12	Input / Output	High density/Sub D	
1	O	+24 V DC output (max. 400mA)	
2	O0	No error	Only for "fixed assignment" Functions are available, if "Fixed assignment" was selected for the I/O assignment in the configuration wizard
3	O1	Position / speed / gear synchronization attained (max. 100 mA)	
4	O2	Power stage without current (max. 100mA)	
5	O3	Axis energized with a setpoint of 0 (max. 100 mA)	
6	I0="1":	Quit (positive edge) / activate the axis	
	I0="0"	Axis disable with delay	
7	I1	no Stop	
8	I2	JOG +	
9	I3	JOG -	
10	I4	Reg input	
11	I	24V input for the digital outputs Pins 2 to 5	
12	I5	Limit switch 1	
13	I6	Limit switch 2	
14	I7	Machine zero initiator	
15	O	GND24V	

All inputs and outputs have 24V level.

Maximum capacitive loading of the outputs: 30nF (max. 2 Compax3 inputs can be connected)

Input-/Output extension (see on page 129)

Optimization window display

The display of the digital inputs in the optimization window of the C3 ServoManager does not correspond to the physical status (24Volt=on, 0Volt=off) but to the logic status: if the function of an input or output is inverted (e.g. limit switch, negatively switching), the corresponding display (LED symbol in the optimization window) is OFF with 24Volts at the input and ON with 0 Volts at the input.

For intra-device inputs I0 .. I3 as well as the outputs O0 ... O3 you can choose between fixed or free assignment.

With fixed assignment of the intra-device inputs I0 ... I3, the respective functions can either be triggered via the inputs or via RS232 / RS485

It applies:

- ◆ The motor is only energized if I0 = "1" AND control word Bit 0 ="1"
- ◆ Stop is active if, I1 ="0" OR Control word Bit 1 ="0"
- ◆ Manual+ and Manual- inputs and control word are OR - linked.

5.2.2. Control Word

Structure of the control word (object 1100.3)

Bit	Function	Corresponds to *
Bit0	Quit (edge) / energize axis	I0: X12/6
Bit1	No Stop	I1: X12/7
Bit2	JOG +	I2: X12/8
Bit3	JOG -	I3: X12/9
Bit4	O0 X12/2	(only if O0...O3 is defined as freely assignable)
Bit5	O1 X12/3	
Bit6	O2 X12/4	
Bit7	O3 X12/5	
Bit8	Address 0	
Bit9	Address 1	
Bit10	Address 2	
Bit11	Address 3	
Bit12	Address 4	
Bit13	Start (edge) The address of the current motion set is read in new.	
Bit14	No Stop (2nd Stop)	
Bit15	Open brake	

* does only apply if the respective inputs are assigned fixedly.
Bit0 = least significant Bit

5.2.3. Status word 1 & 2

Structure of the state word 1 (object 1000.3)

Bit	Description	Corresponds to *
Bit0	I0	X12/6
Bit1	I1	X12/7
Bit2	I2	X12/8
Bit3	I3	X12/9
Bit4	I4	X12/10
Bit5	I5	X12/11
Bit6	I6	X12/12
Bit7	I7	X12/13
Bit8	No error	X12/2
Bit9	Position reached	X12/3
Bit10	Axis powerless	X12/4
Bit11	Axis stationary with current at setpoint value zero	X12/5
Bit12	Machine zero (home) Position known	
Bit13	Programmable status bit 0 (PSB0)	
Bit14	Programmable status bit 1 (PSB1)	
Bit15	Programmable status bit 2 (PSB2) <C3F_2_axes_alignment>	

* Does apply for Bit 8 ... 11 only if the respective outputs (O0 ... O3) are assigned fixedly.

Bit0 = least significant Bit

Structure of the state word 2 (object 1000.4)

Bit	Description	
Bit0 ... 14	factory use	
Bit15	Reg detected	

Bit0 = least significant Bit

5.3 Examples include: Control via COM port

- ◆ Control via COM port is executed via the control word (object 1100.3) and the status word (object 1000.3).
- ◆ These examples are based on the ASCII record, they may, however, also be realized on the binary record. The binary record offers the advantage, that the transmission is ensured by the CRC verification.
- ◆ The commands can also be entered via a HyperTerminal (terminal setting is 115200.8.N.1 with hardware flow control).
 - ◆ Recommendation for Compax3S/H/F: Local echo and connection of CR/LF
 - ◆ Recommendation for Compax3M: Local echo and connection of CR (otherwise danger of data collisions on the USB bus)

Activation of the axis:

Command:	break	/Stop	Start	Addr4	Addr3	Addr2	Addr1	Addr0	O3	O2	O1	O0	Jog-	Jog+	/Stop	Quit / motor
o1100.3=1	0	0	0	0	0	0	0	0	0	0	0	0	0	0	0	1

Manual motion (manual+)

Command:	break	/Stop	Start	Addr4	Addr3	Addr2	Addr1	Addr0	O3	O2	O1	O0	Jog-	Jog+	/Stop	Quit / motor
o1100.3=\$4007	0	1	0	0	0	0	0	0	0	0	0	0	0	1	1	1

Approach machine zero

Command:	break	/Stop	Start	Addr4	Addr3	Addr2	Addr1	Addr0	O3	O2	O1	O0	Jog-	Jog+	/Stop	Quit / motor
o1100.3=\$4003	0	1	0	0	0	0	0	0	0	0	0	0	0	0	1	1

First of all was ensured, that Start is at 0, as a rising edge is required for triggering a motion.

Start - edge

Command:	break	/Stop	Start	Addr4	Addr3	Addr2	Addr1	Addr0	O3	O2	O1	O0	Jog-	Jog+	/Stop	Quit / motor
o1100.3=\$6003	0	1	1	0	0	0	0	0	0	0	0	0	0	0	1	1

Then the set is started with address 0 (=always reference run).

Acknowledge Error

At first the errors can be read:

o550.1 read last error
o550.2 read last but one error

...

In the error history the executed error acknowledgements are also listed (value=1). This helps you to read out the errors that occurred since the last acknowledgement.

If the cause of an error is eliminated, the error can be acknowledged. To do this, you will need a rising edge on Bit 0.

Set ackn to "0"

Command:	break	/Stop	Start	Addr4	Addr3	Addr2	Addr1	Addr0	O3	O2	O1	O0	Jog-	Jog+	/Stop	Quit / motor
o1100.3=0	0	0	0	0	0	0	0	0	0	0	0	0	0	0	0	0

Ackn - edge

Command:	break	/Stop	Start	Addr4	Addr3	Addr2	Addr1	Addr0	O3	O2	O1	O0	Jog-	Jog+	/Stop	Quit / motor
o1100.3=\$4003	0	1	0	0	0	0	0	0	0	0	0	0	0	0	1	1

Read out status

The status word1 can be accessed via object 1000.3.
Command:

o1000.3

The address of the set executed last can be read out via status word2 object 1000.4:

o1000.4**Description of the set table**

The set table can be written in either via the Compax3 ServoManager or directly via the COM port.

Example:

Entry of a motion set in set 5.

- Motion set:**
- ◆ Absolute positioning on position 234,54
 - ◆ Velocity 21,4
 - ◆ Acceleration 200
 - ◆ Deceleration 500
 - ◆ Jerk maximum 10000
 - ◆ Programmable status bits:
 - ◆ PSB2 must remain unchanged
 - ◆ PSB1 = 1 and
 - ◆ PSB0 = 0.

The following commands are to be transmitted:

o1901.5=234.54 Target position (column 1, row 5)
 o1902.5=21.4 Velocity (column 2, row 5)
 o1905.5=1 Mode=1 (MoveAbs)
 o1906.5=200 Accel
 o1907.5=500 Decel
 o1908.5=10000 Jerk

The control word for the control of the PSBs is made up as follows:

Bit 7	Bit 6	Bit 5	Bit 4	Bit 3	Bit 2	Bit 1	Bit 0	Value
-	Ena PSB2	Ena PSB1	Ena PSB0	-	PSB 2	PSB 1	PSB 0	
0	0	1	1	0	0	1	0	=\$32

Command for the entry into the set table:
 o1904.5=\$32

Modifications of set parameters must be made before the start of the respective set.

After the start of the set, the parameters can be modified again, even if the respective set is not yet completed.

Changing the ignore zone

Changes of the ignore zone for registration search [RegSearch] can also be made via RS232. The following objects must be changed:

o3300.8 Beginning of the ignore zone
 o3300.9 End of the ignore zone

. The value for the beginning of the ignore zone must always be smaller than the value for the end of the ignore zone. Only positive values are to be entered.

5.4 Layout of the set table

In this chapter you can read about:

General layout of the table.....277
 Assignment of the different motion functions.....277
 Definition of the states of the programmable status bits (PSBs):.....278

The motion sets are memorized in an object table. The table has 9 columns and 32 rows.

A motion set is stored in a table row.

The assignment of the columns depends on the motion function.

5.4.1. General layout of the table

	Column 1 Type: REAL objects O1901	Column 2 Type: REAL objects O1902	Column 3 Type: INT objects O1903	Column 4 Type: INT objects O1904	Column 5 Type: INT objects O1905	Column 6 Type: DINT objects O1906	Column 7 Type: DINT objects O1907	Column 8 Type: DINT objects O1908	Column 9 Type: DINT objects O1909
Set 1	Row 1 "Array_Col1_Row1" (1901.1)	Row 1 "Array_Col2_Row1" (1902.1)	Row 1 "Array_Col3_Row1" (1903.1)	Row 1 "Array_Col4_Row1" (1904.1)	Row 1 "Array_Col5_Row1" (1905.1)	Row 1 "Array_Col6_Row1" (1906.1)	Row 1 "Array_Col7_Row1" (1907.1)	Row 1 "Array_Col8_Row1" (1908.1)	Row 1 "Array_Col9_Row1" (1909.1)
set no. 2
Set 3
...
Set 31	Row 31 "Array_Col1_Row31" (1901.31)	Row 31 "Array_Col2_Row31" (1902.31)	Row 31 "Array_Col3_Row31" (1903.31)	Row 31 "Array_Col4_Row31" (1904.31)	Row 31 "Array_Col5_Row31" (1905.31)	Row 31 "Array_Col6_Row31" (1906.31)	Row 31 "Array_Col7_Row31" (1907.31)	Row 31 "Array_Col8_Row31" (1908.31)	Row 31 "Array_Col9_Row31" (1909.31)

You will find the respective object number in brackets.

5.4.2. Assignment of the different motion functions

The columns 3 and 9 are reserved.

Motion-functions	Column 1	Column 2	Column 4	Column 5	Column 6	Column 7	Column 8
	Type: REAL Objects O1901	Type: REAL Objects O1902	Type: INT Objects O1904	Type: INT Objects O1905	Type: DINT Objects O1906	Type: DINT Objects O1907	Type: DINT Objects O1908
	Positions	Speed	Programmiers tatusbits (PSBs)	Mode	Accelerations	Deceleration / denominator	Jerk
MoveAbs (see on page 140)	Target position	Speed	PSBs	1 (for MoveAbs)	Accel	Decel	Jerk
MoveRel (see on page 140)	Distance	Speed	PSBs	2 (for MoveRel)	Accel	Decel	Jerk
Gearing (see on page 145)	-	Numerator	PSBs	3 (for Gearing)	Accel	Denominator	-
RegSearch (see on page 141)	Distance	Speed	PSBs	4 (for RegSearch)	Accel	Decel	Jerk
RegMove (see on page 141)	Offset	Speed	PSBs	5 (for RegMove)	-	-	-
Velocity (see on page 147)	-	Speed	PSBs	6 (for Velocity)	Accel	-	-
STOP	-	-	PSBs	7 (for Stop)	-	Decel	Jerk

5.4.3. Definition of the states of the programmable status bits (PSBs):

Bit 7	Bit 6	Bit 5	Bit 4	Bit 3	Bit 2	Bit 1	Bit 0
factory use	Enable2 PSB2	Enable1 PSB1	Enable0 PSB0	factory use	PSB2	PSB1	PSB0
	="1": Set PSB ="0": leave PSB unchanged						

The Bits 0 ... 2 monitor the states of the status bits at the end of a motion set, if the bits were enabled via the respective Enable.

If Enable is set to "0", the respective PSB remains unchanged at the end of the motion set.

PSB0: X22/12 or SW.13

PSB1: X22/13 or SW.14

PSB2: X22/14 or SW.15

5.5 Compax3 communication variants

In this chapter you can read about:

PC <-> Compax3 (RS232).....	279
PC <-> Compax3 (RS485).....	280
PC <-> C3M device combination (USB).....	281
USB-RS485 Moxa Uport 1130 adapter.....	282
ETHERNET-RS485 NetCOM 113 adapter.....	283
Modem MB-Connectline MDH 500 / MDH 504.....	284
C3 settings for RS485 two wire operation.....	285
C3 settings for RS485 four wire operation.....	286
Overview of all possible communication modes between Compax3 devices and a PC.	

5.5.1. PC <-> Compax3 (RS232)

PC <-> Compax3 (RS232): Connections to a device

PC (RS232 COM)



115kb



PC (Virtueller ComPort)



USB/RS232



115kb



PC (Virtueller ComPort)



10/100/1000Mb



Ethernet (LAN)

Ethernet/RS232



115kb



PC (RS232 COM)



115kb



Modem

TelefonNetz



Max 33.6kb



Modem

115kb



PC (Virtueller ComPort)



10/100/1000Mb



Ethernet (LAN)



WLAN/RS232



115kb



PC (Virtueller ComPort)



115kb

RS232



Analoges Telefonnetz
GSM / ISDN
Telephone Network



115kb

RS232



5.5.2. PC <-> Compax3 (RS485)

PC <-> Compax3 (RS485)

PC (RS232 COM)



115kb

C3 (X10 / RS485)



PC (Virtueller ComPort)



115kb

C3 (X10 / RS485)



PC (Virtueller ComPort)

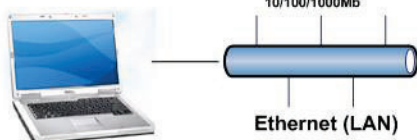

Ethernet/RS485



115kb

C3 (X10 / RS485)



PC (Virtueller ComPort)



Analoges Telefonnetz
GSM / ISDN
Telephone Network



115kb
RS485



TD-36/RS485

C3M X31

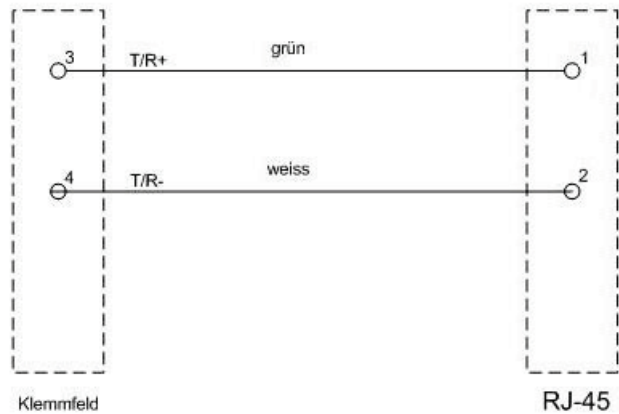

5.5.3. PC <-> C3M device combination (USB)

PC <-> C3M device combination

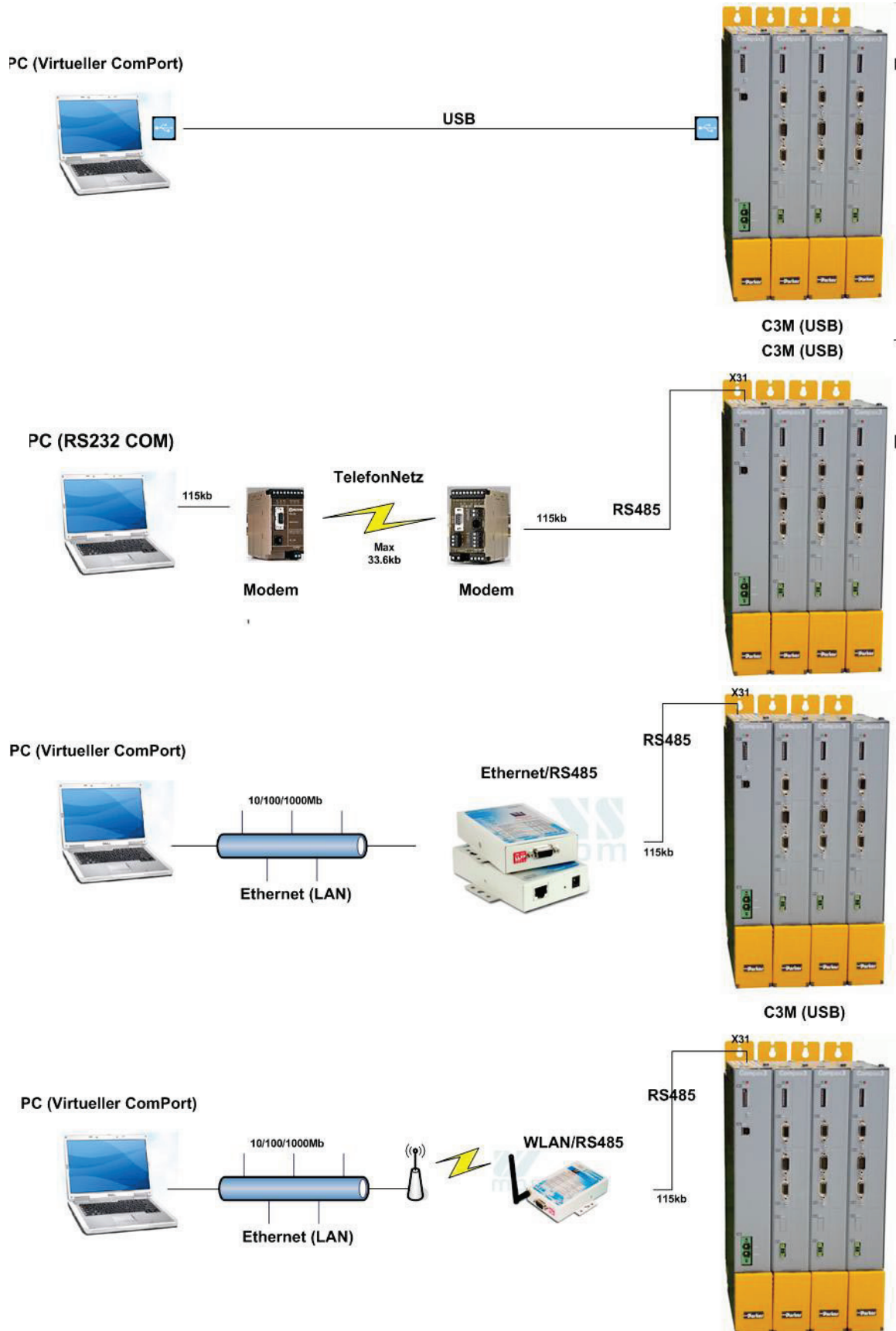

5.5.4. USB-RS485 Moxa Uport 1130 adapter



Male DB9

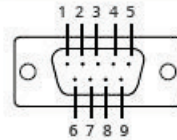

PIN	RS-422/4-wire RS-485	2-wire RS-485
1	TxD-(A)	-
2	TxD+(B)	-
3	RxD+(B)	Data+(B)
4	RxD-(A)	Data-(A)

PIN	RS-422/4-wire RS-485	2-wire RS-485
5	GND	GND
6	-	-
7	-	-
8	-	-

The serial UPort 1130 USB adapter offers a simple and comfortable method of connecting an RS-422 or RS-485 device to your laptop or PC. The UPort 1130 is connected to the USB port of your computer and complements your workstation with a DB9 RS-422/485 serial interface. For simple installation and configuration, Windows drivers are already integrated. The UPort 1130 can be used with new or legacy serial devices and supports both 2- and 4-wire RS-485. It is especially suited for mobile, instrumentation and point-of-sale (POS) applications.

Manufacturer link http://www.moxa.com/product/UPort_1130_1130I.htm

Connection plan for Compax3S:

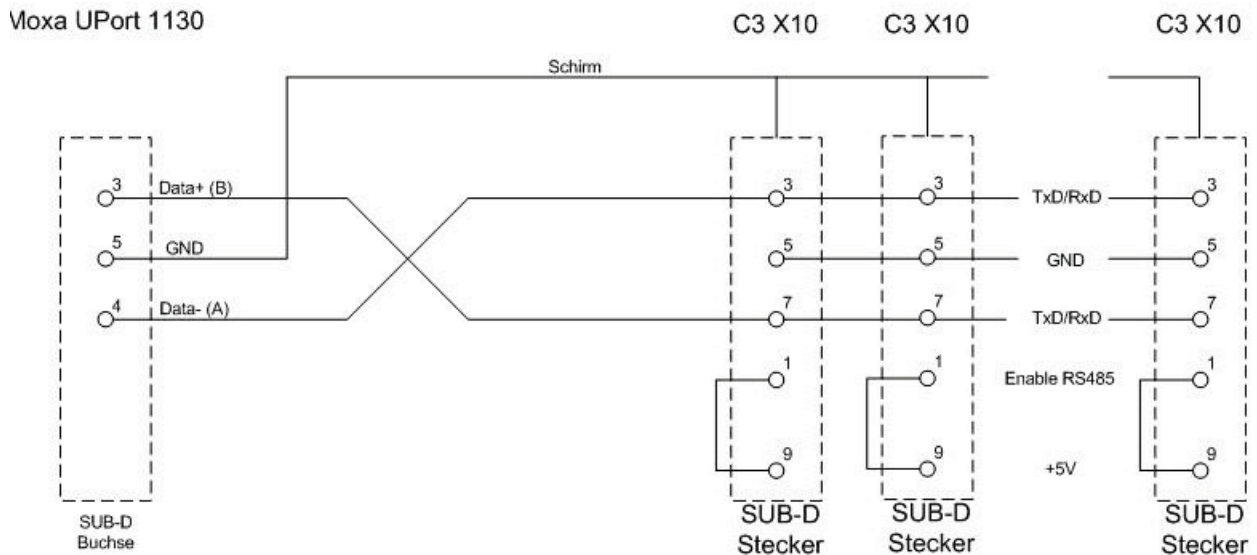

5.5.5. ETHERNET-RS485 NetCOM 113 adapter



Manufacturer link: <http://www.vscom.de/666.htm>
 (<http://www.vscom.de/666.htm>)

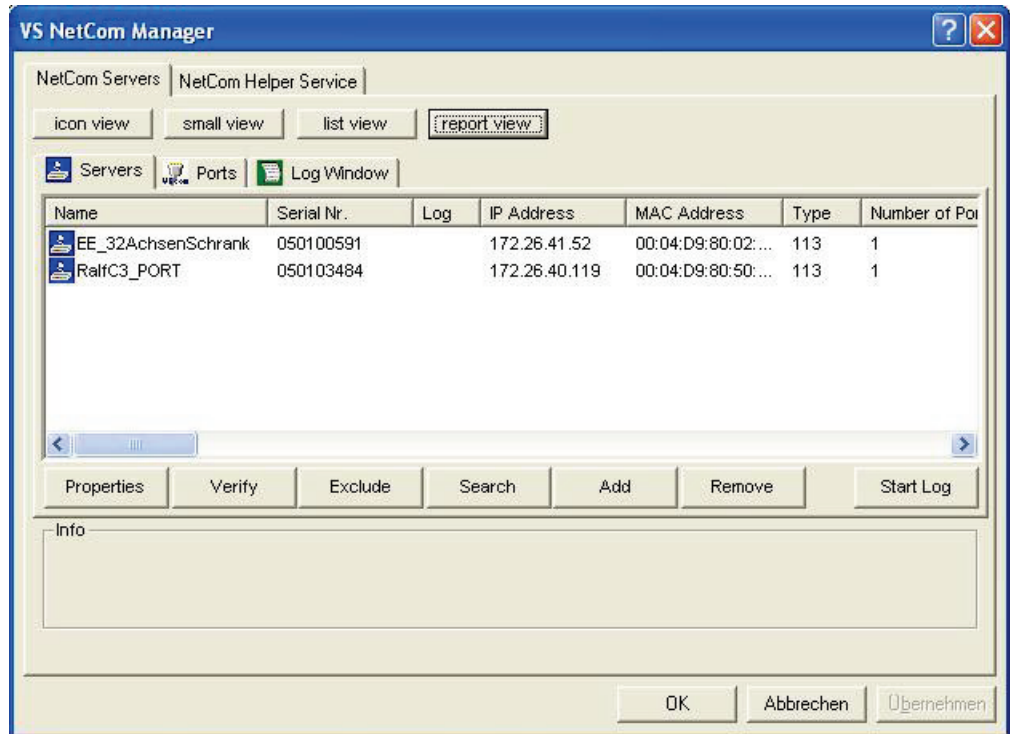

DIP Switch settings NetCom 113 for two-wire operation:

1ON 2ON 3off 4off (Mode: RS485 by ART (2 wire without Echo))

Communication settings C3S/C3M:

Object	Function	Value
810.1	Protocol	16 (two wire)
810.2	Baud rate	115200
810.3	NodeAddress	1..254
810.4	Multicast Address	

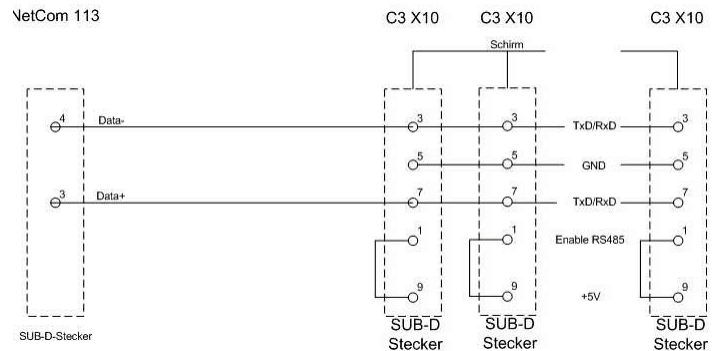
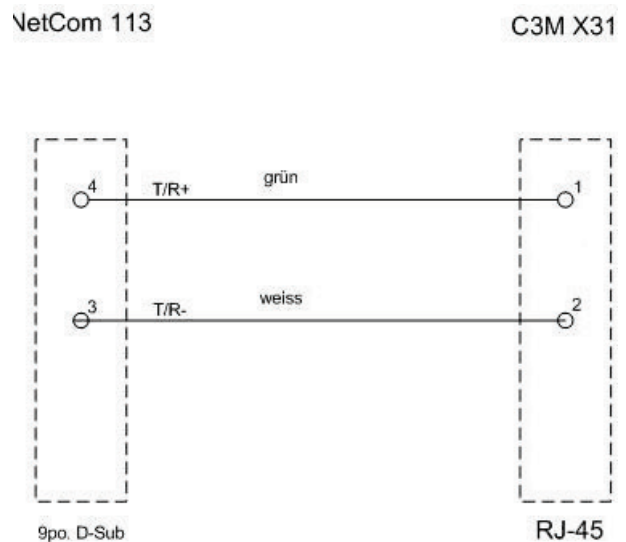
Connection plan NetCom113 <-> C3S :**Connection plan NetCom113 <-> C3M X31:****5.5.6. Modem MB-Connectline MDH 500 / MDH 504**

With the modems MDH500 and MDH504 manufactured by MB-Connectline, you can establish an independent connection. A virtual COM port is generated and the communication with the PC as well as the Compax3 takes place via RS232 or RS485.

It is not necessary to make any modem settings on the Compax3.

5.5.7. C3 settings for RS485 two wire operation

C3 ServoManager RS485 wizard settings:
 download with configuration in RS232 mode!

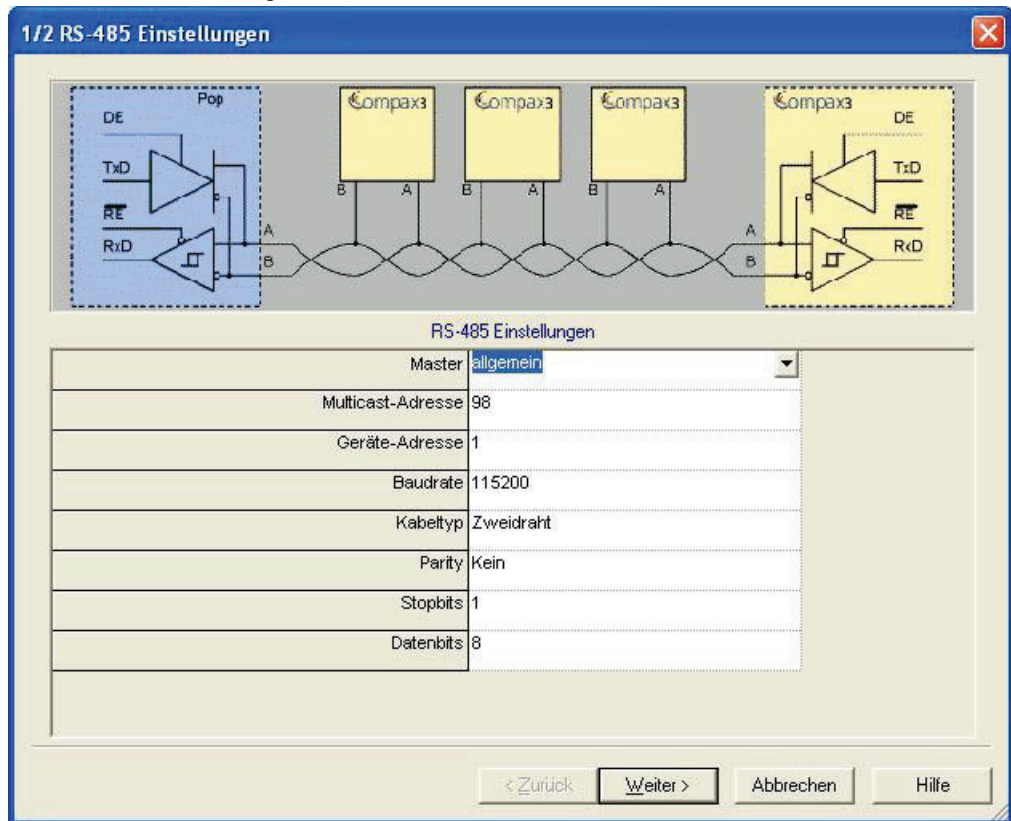

Communication settings C3S/C3M:

Object	Function	Value
810.1	Protocol	16 (two wire)
810.2	Baud rate	115200
810.3	NodeAddress	1..254
810.4	Multicast Address	

5.5.8. C3 settings for RS485 four wire operation

C3 ServoManager RS485 wizard settings:

download with configuration in RS232 mode

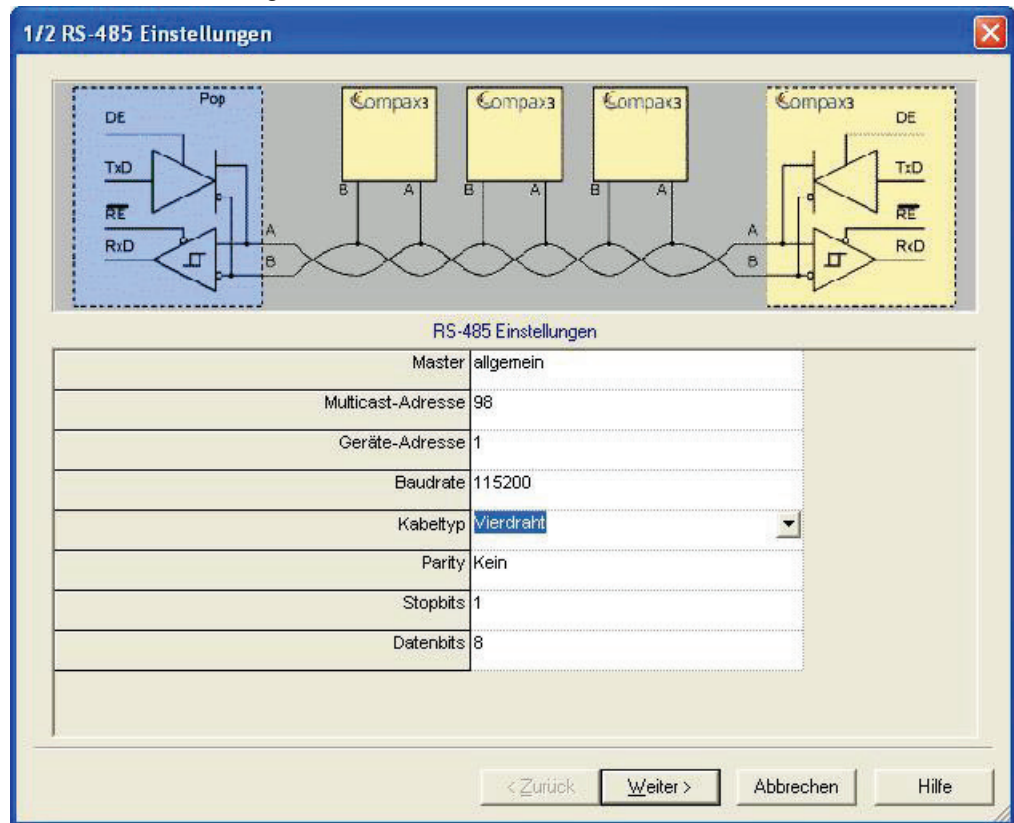

Communication settings C3S/C3M:

Object	Function	Value
810.1	Protocol	0 (4 wire)
810.2	Baud rate	115200
810.3	NodeAddress	1..254
810.4	Multicast Address	

5.6 COM port protocol

You can communicate with Compax3 in order to read or write objects via plug X10 (or X3 on the mains module of Compax3M) on the front via a COM port (max. 32 nodes).

As a rule 2 records are possible:

- ◆ ASCII record: simple communication with Compax3
- ◆ Binary record: fast and secure communication with Compax3 by the aid of block securing.

Switching between the ASCII and the binary record via automatic record detection.

Interface settings (see on page 364)

- Wiring** RS232: **SSK1** (see on page 342)
 RS485: as **SSK27** (see on page 343) / RS485 is activated by +5V on X10/1.
 USB: SSK33/03 (only for Compax3M)

In this chapter you can read about:

RS485 settings values	287
ASCII - record	287
Binary record	288

5.6.1. RS485 settings values

If "Master=Pop" is selected, only the settings compatible with the Pops (Parker Operator Panels) made by Parker are possible.

**Please note that the connected Pop has the same RS485 setting values.
 You can test this with the "PopDesigner" software.**

"Master=General" makes all Compax3 settings possible.

Multicast Address You can use this address to allow the master to access multiple devices simultaneously.

Device Address The device address of the connected Compax3 can be set here.

Baud rate Adjust the transfer speed (baud rate) to the master.

Cable type Please choose between **two-wire and four-wire RS485** (see on page 58).

Protocol Adjust the protocol settings to the settings of your master.

5.6.2. ASCII - record

The general layout of a command string for Compax3 is as follows:

[Adr] command CR

Adr	RS232: no address RS485: Compax3 address in the range 0 ... 99 Address settings can be made in the C3 ServoManager under "RS485 settings"
Command	valid Compax3 command
CR	End sign (carriage return)

Command A command consists of the representable ASCII characters (0x21 .. 0x7E). Small letters are converted automatically into capitals and blanks (0x20) are deleted, if they are not placed between two quotation marks.
Separator between places before and after the decimal is the decimal point (0x2E). A numeric value can be given in the Hex-format if it is preceded by the "\$" sign. Values can be requested in the Hex-format if the CR is preceded additionally by the "\$" sign.

Answer strings All commands requesting a numeric value from Compax3 are acknowledged with the respective numeric value in the ASCII format followed by a CR without preceding command repetition and following statement of unit. The length of these answer strings differs depending on the value.
Commands requesting an Info-string (e.g. software version), are only acknowledged with the respective ASCII character sequence followed by a CR, without preceding command repetition. The length of these answer strings is here constant.
Commands transferring a value to Compax3 or triggering a function in Compax3 are acknowledged by:

>CR

if the value can be accepted resp. if the function can be executed at that point in time.

If this is not the case or if the command syntax was invalid, the command is acknowledged with

!xxxxCR

The 4 digit error number **xxxx** is given in the HEX format; you will find the meaning in the **appendix** (see on page 301).

RS485 answer string When using RS485, each answer string is preceded by a "*" (ASCII - character: 0x2A).

Compax3 commands

Read object *RS232: O [\$] Index , [\$] Subindex [\$]*

RS485: Address O [\$] Index , [\$] Subindex [\$]

The optional "\$" after the subindex stands for "hex-output" which means that an object value can also be requested in hex;
For example "O \$0192.2\$": (Object 402.2)

Write object *RS232: O [\$] Index , [\$] Subindex = [\$] Value [; Value2 ; Value3 ; ...]*

RS485: Address O [\$] Index , [\$] Subindex = [\$] Value [; Value2 ; Value3 ; ...]

The optional "\$" preceding Index, Subindex and value stands for "Hex-input" which means that Index, Subindex and the value to be transferred can also be entered in hex (e.g. O \$0192.2=\$C8).

5.6.3. Binary record

The binary record with block securing is based on 5 different telegrams:

- ◆ 2 request telegrams which the control sends to Compax3 and
- ◆ 3 response telegrams which Compax3 returns to the control.

Telegram layout

Basic structure:

Start code	Address	Number of data bytes - 1	Data				Block securing	
SZ	A	L	D0	D1	...	Dn	Crc(Hi)	Crc(Lo)

The start code defines the frame type and is composed as follows:

Bit	7	6	5	4	3	2	1	0
Frame type	Frame identification				PLC		Gateway	Address
RdObj read object	1	0	1	0	x	1	x	x
WrObj write object	1	1	0	0	x	1	x	x
Rsp response	0	0	0	0	0	1	0	1
Ack positive command acknowledgement	0	0	0	0	0	1	1	0
Nak Negative command acknowledgement	0	0	0	0	0	1	1	1

Bits 7, 6, 5 and 4 of the start code form the telegram identification; Bit 2 is always "1".

Bits 3, 1 and 0 have different meanings for the request and response telegrams. The address is only necessary for RS484.

Request telegrams

-> Compax3

- ◆ the address bit (Bit 0 = 1) shows if the start code is followed by an address (only for RS485; for RS232 Bit 0 = 0)
- ◆ the gateway bit (Bit 1 = 1) shows if the message is to be passed on. (Please set Bit 1 = 0, as this function is not yet available)
- ◆ the PLC bit (Bit 3 = 1) allows access to objects in the PLC/Pop format
 U16, U32: for integer formats (see bus formats: Ix, Ux, V2)
 IEEE 32Bit Floating Point: for non integer formats (bus formats: E2_6, C4_3, Y2, Y4; without scaling)
 With Bit 3 = 0 the objects are transmitted in the DSP format.
 DSP formats:
 24 Bit = 3 Bytes: Integer INT24 or Fractional FRACT24
 48 Bit = 6 Bytes: Real REAL48 (3 Byte Int, 3 Byte Fract) / Double Integer DINT48 / Double Fractional DFRACT48

Response telegram

Compax3 ->

- ◆ Bits 0 and 1 are used to identify the response
- ◆ Bit 3 is always 0

The maximum number of data bytes in the request telegram is 256, in the response telegram 253.

The block securing (CRC16) is made via the CCITT table algorithm for all characters.

After receiving the start code, the timeout monitoring is activated in order to avoid that Compax3 waits in vain for further codes (e.g. connection interrupted) The timeout period between 2 codes received is fixed to 5ms (5 times the code time at 9600Baud)

Write object - WrObj telegram

SZ	Adr	L	D0	D1	D2	D3 ... Dn	Crc(Hi)	Crc(Lo)
0xCX		n	Index(Hi)	Index(Lo)	Subindex	Value	0x..	0x..

Describing an object by a value.

Positive acknowledgement - Ack-telegram

SZ	L	D0	D1	Crc(Hi)	Crc(Lo)
0x06	1	0	0	0x..	0x..

Answer from Compax3 if a writing process was successful, i.e. the function could be executed and is completed in itself.

Negative acknowledgement - Nak - telegram

SZ	L	D0	D1	Crc(Hi)	Crc(Lo)
0x07	1	F-No.(Hi)	F-No.(Lo)	0x..	0x..

Answer from Compax3 if access to the object was denied (e.g. function cannot be executed at that point in time or object has no reading access). The error no. is coded according to the DriveCom profile resp. the CiA Device Profile DSP 402.

Read object - RdObj - telegram

SZ	Adr	L	D0	D1	D2	D3	D4	D5	...	Dn	Crc(Hi)	Crc(Lo)
0xAX		n	Index1(Hi)	Index1(Lo)	Subindex1	Index2(Hi)	Index2(L o)	Subindex2	0x..	0x..

Reading one or several objects

Answer - Rsp - telegram

SZ	L	D0 ... Dx-1	Dx ... Dy-1	Dy-D..	D ... D..	D ... Dn	Crc(Hi)	Crc(Lo)
0x05	n	Value1	Value 2	Value 3	Value ..	Value n	0x..	0x..

Answer from Compax3 if the object can be read.

If the object has no reading access, Compax3 answers with the Nak - telegram.

Example:**Reading object "StatusPositionActual" (o680.5):**

Request: A5 03 02 02 A8 05 E1 46

Response: 05 05 FF FF FF FF FE 2D 07 B4

Writing into an Array (o1901.1 = 2350)

Request: C5 02 08 07 6D 01 00 09 2E 00 00 00 95 D5

Response: 06 01 00 00 BA 87

Block securing: Checksum calculation for the CCITT table algorithm

The block securing for all codes is performed via the following function and the corresponding table:

The "CRC16" variable is set to "0" before sending a telegram.

Function call:

```
CRC16 = UpdateCRC16(CRC16, Character);
```

This function is called up for each Byte (Character) of the telegram.

The result forms the last two bytes of the telegram

Compax3 checks the CRC value on receipt and reports CRC error in the case of a deviation.

```
Function const unsigned int _P CRC16_table[256] = {
    0x0000, 0x1021, 0x2042, 0x3063, 0x4084, 0x50a5, 0x60c6, 0x70e7,
    0x8108, 0x9129, 0xa14a, 0xb16b, 0xc18c, 0xd1ad, 0xe1ce, 0xf1ef,
    0x1231, 0x0210, 0x3273, 0x2252, 0x52b5, 0x4294, 0x72f7, 0x62d6,
    0x9339, 0x8318, 0xb37b, 0xa35a, 0xd3bd, 0xc39c, 0xf3ff, 0xe3de,
    0x2462, 0x3443, 0x0420, 0x1401, 0x64e6, 0x74c7, 0x44a4, 0x5485,
    0xa56a, 0xb54b, 0x8528, 0x9509, 0xe5ee, 0xf5cf, 0xc5ac, 0xd58d,
    0x3653, 0x2672, 0x1611, 0x0630, 0x76d7, 0x66f6, 0x5695, 0x46b4,
    0xb75b, 0xa77a, 0x9719, 0x8738, 0xf7df, 0xe7fe, 0xd79d, 0xc7bc,
    0x48c4, 0x58e5, 0x6886, 0x78a7, 0x0840, 0x1861, 0x2802, 0x3823,
    0xc9cc, 0xd9ed, 0xe98e, 0xf9af, 0x8948, 0x9969, 0xa90a, 0xb92b,
    0x5af5, 0x4ad4, 0x7ab7, 0x6a96, 0x1a71, 0x0a50, 0x3a33, 0x2a12,
    0xdbfd, 0xcbdc, 0xfbbf, 0xeb9e, 0x9b79, 0x8b58, 0xbb3b, 0xab1a,
    0x6ca6, 0x7c87, 0x4ce4, 0x5cc5, 0x2c22, 0x3c03, 0x0c60, 0x1c41,
    0xedae, 0xfd8f, 0xcdec, 0xddcd, 0xad2a, 0xbd0b, 0x8d68, 0x9d49,
    0x7e97, 0x6eb6, 0x5ed5, 0x4ef4, 0x3e13, 0x2e32, 0x1e51, 0x0e70,
    0xff9f, 0xefbe, 0xdfdd, 0xcffc, 0xbf1b, 0xaf3a, 0x9f59, 0x8f78,
    0x9188, 0x81a9, 0xb1ca, 0xa1eb, 0xd10c, 0xc12d, 0xf14e, 0xe16f,
    0x1080, 0x00a1, 0x30c2, 0x20e3, 0x5004, 0x4025, 0x7046, 0x6067,
    0x83b9, 0x9398, 0xa3fb, 0xb3da, 0xc33d, 0xd31c, 0xe37f, 0xf35e,
    0x02b1, 0x1290, 0x22f3, 0x32d2, 0x4235, 0x5214, 0x6277, 0x7256,
    0xb5ea, 0xa5cb, 0x95a8, 0x8589, 0xf56e, 0xe54f, 0xd52c, 0xc50d,
    0x34e2, 0x24c3, 0x14a0, 0x0481, 0x7466, 0x6447, 0x5424, 0x4405,
    0xa7db, 0xb7fa, 0x8799, 0x97b8, 0xe75f, 0xf77e, 0xc71d, 0xd73c,
    0x26d3, 0x36f2, 0x0691, 0x16b0, 0x6657, 0x7676, 0x4615, 0x5634,
    0xd94c, 0xc96d, 0xf90e, 0xe92f, 0x99c8, 0x89e9, 0xb98a, 0xa9ab,
    0x5844, 0x4865, 0x7806, 0x6827, 0x18c0, 0x08e1, 0x3882, 0x28a3,
    0xcb7d, 0xdb5c, 0xeb3f, 0xfb1e, 0x8bf9, 0x9bd8, 0xabbb, 0xbb9a,
    0x4a75, 0x5a54, 0x6a37, 0x7a16, 0x0af1, 0x1ad0, 0x2ab3, 0x3a92,
    0xfd2e, 0xed0f, 0xdd6c, 0xcd4d, 0xbdaa, 0xad8b, 0x9de8, 0x8dc9,
    0x7c26, 0x6c07, 0x5c64, 0x4c45, 0x3ca2, 0x2c83, 0x1ce0, 0x0cc1,
    0xef1f, 0xff3e, 0xcf5d, 0xdf7c, 0xaf9b, 0xbfba, 0x8fd9, 0x9ff8,
    0x6e17, 0x7e36, 0x4e55, 0x5e74, 0x2e93, 0x3eb2, 0x0ed1, 0x1ef0
};

unsigned int UpdateCRC16(unsigned int crc,unsigned char wert) {

unsigned int crc16;

crc16 = (CRC16_table[(crc >> 8) & 0x00FF] ^ (crc << 8)
^ (unsigned int)(value));

return crc16;

}

```

You will find this function on the Compax3 DVD under RS232_485\Function UpdateCRC16.txt!

5.7 Remote diagnosis via Modem

Caution!

As the transmission via modem may be very slow and interference-prone, the operation of the Compax3 ServoManager via modem connection is on your own risk!

The function setup mode as well as the ROLL mode of the oscilloscope are not available for remote diagnosis!

It is not recommended to use the logic analyzer in the Compax3 IEC61131-3 debugger due to the limited bandwidth.

Requirements:

For modem operation, a direct and stable telephone connection is required. Operation via a company-internal telephone system is not recommended.

In this chapter you can read about:

Structure.....	292
Configuration of local modem 1	293
Configuration of remote modem 2.....	294
Recommendations for preparing the modem operation.....	294

5.7.1. Structure

Layout and configuration of a modem connection ServoManager - Compax3:

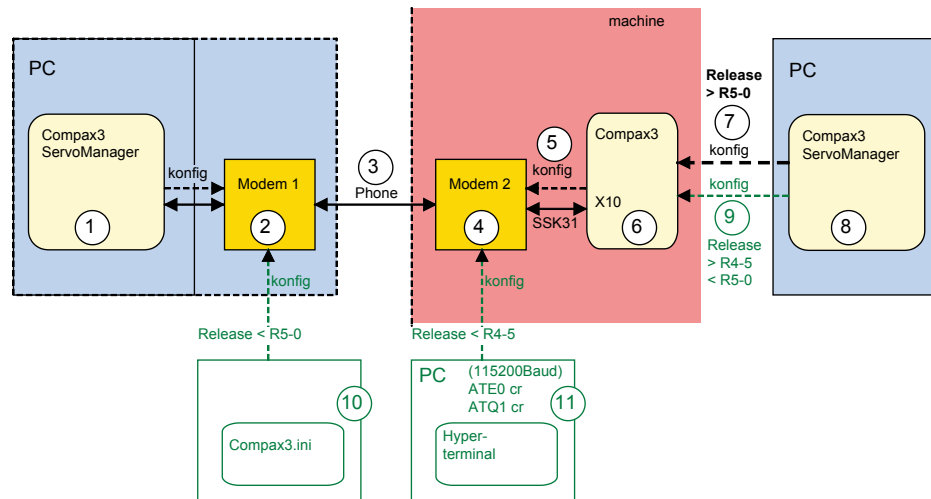

The green part of the drawing shows the proceeding for Compax3 release versions < R5-0!

The proceeding for Compax3 release versions < R5-0 is described in an application example (.../modem/C3_AppI_A1016_ *language*.pdf on the Compax3 CD).

Connection Compax3 ServoManager <=> Compax3

The Compax3 ServoManager (1) establishes a RS232 connection with modem 1 (PC internal or external).

Modem 1 dials modem 2 via a telephone connection (3).

Modem 2 communicates with Compax3 (6) via RS232.

Configuration

Modem 1 is configured via the Compax3 ServoManager (1)

Modem 2 can be configured via Compax3 (on place), triggered by putting **SSK31** (see on page 346) on X10. For this, the device must be configured before. This can be made locally before the system / machine is delivered with the aid of the Compax3 ServoManager (8).

5.7.2. Configuration of local modem 1

- ◆ Menu "Options: Communication settings RS232/RS485..." must be opened
- ◆ Select "Connection via Modem"
- ◆ Under "name" you can enter a name for the connection
- ◆ Enter the target telephone number.
 - Note: If an ISDN telephone system is operated within a company network, an additional "0" may be required in order to get out of the local system into the company network before reaching the outside line with an additional "0".
- ◆ The timeout periods are set to reasonable standard values according to our experience.
- ◆ Select the modem type.
 - ◆ For "user-defined modem", additional settings are only required, if the modem does not support standard AT commands.
 - Then you can enter special AT commands.
 - ◆ **Hint:**When operating the local modem on a telephone system, it may be necessary to make a blind dialing. Here, the modem does not wait for the dialing tone.
- ◆ Select the COM interface where the modem is connected.
- ◆ Close the window and establish the connection with button  (open/close COM port).
- ◆ The connection is interrupted when the COM port is closed.
- ◆ Select the modem type.
 - ◆ For "user-defined modem", additional settings are only required, if the modem does not support standard AT commands.
 - Then you can enter special AT commands.
 - ◆ **Hint:**When operating the local modem on a telephone system, it may be necessary to make a blind dialing. Here, the modem does not wait for the dialing tone.

5.7.3. Configuration of remote modem 2

Settings in Compax3 under "configure communication: Modem settings":

- ◆ Modem initialization = "ON": After the SSK31 modem cable has been connected, Compax3 initializes the modem
- ◆ Modem initialization after Power On = "ON": After Power on of Compax3, the device initializes the modem
- ◆ Modem check = "ON": a modem check is performed
- ◆ The timeout periods are set to reasonable standard values according to our experience.
- ◆ Select the modem type.
 - ◆ For "user-defined modem", additional settings are only required, if the modem does not support standard AT commands. Then you can enter special AT commands.
 - ◆ **Hint:**When operating the local modem on a telephone system, it may be necessary to make a blind dialing. Here, the modem does not wait for the dialing tone.
- ◆ In the following wizard window, a specific download of the modem configuration can be made.

Note:

If a configuration download is interrupted, the original settings in the non volatile memory of the Compax3 are still available.

You have to finish the communication on the PC side and to reset the Compax3 via the 24V supply before you can start a new trial.

Reinitialization of the remote modem 2

Remove cable on Compax3 X10 and connect again!

5.7.4. Recommendations for preparing the modem operation

Preparations:

- ◆ Settings in Compax3 under "configure communication: Modem settings":
 - ◆ Modem initialization: "ON"
 - ◆ Modem initialization after Power On: "ON"
 - ◆ Modem check: "ON"
- ◆ Deposit SSK31 cable in the control cabinet.
- ◆ Install modem in the control cabinet and connect to telephone line.

Remote diagnosis required:

- ◆ On site:
 - ◆ Connect modem to Compax3 X10 via SSK31
 - ◆ Modem is automatically initialized
- ◆ Local:
 - ◆ Connect modem to telephone line
 - ◆ Establish cable connection to modem (COM interface)
 - ◆ Select "connection via modem" under "options: communication settings RS232/RS485...".
 - ◆ Select modem under "selection"
 - ◆ Enter telephone number
 - ◆ Select COM interface (PC - modem)
 - ◆ Establish connection with button  (open/close COM port).

6. Compax3 - Objects

In this chapter you can read about:

Objekt Overview I12 T11296

6.1 Objekt Overview I12 T11

Object-No.	Object name	Object	Access
2100.10	C3.ControllerTuning_FilterSpeed2	Filter actual velocity 2	r/w
120.2	C3.DigitalInput_Value	Status of digital inputs	ro
121.2	C3.DigitalInputAddition_Value	input word of I/O option	ro
133.3	C3.DigitalOutputAddition_Value	output word for I/O option	r/w
2100.8	C3.ControllerTuning_CurrentBandwidth	Current regulator bandwidth	r/w
2100.9	C3.ControllerTuning_CurrentDamping	Current loop - Damping	r/w
2100.21	C3.ControllerTuning_FilterAccel_us	Filter - Actual acceleration	r/w
2100.11	C3.ControllerTuning_FilterAccel2	Filter actual acceleration 2	r/w
2100.20	C3.ControllerTuning_FilterSpeed_us	Control signal filter of velocity control	r/w
2230.20	C3.D_CurrentController_Ld_Lq_Ratio	Ratio direct to quadrature inductance	r/w
2230.24	C3.D_CurrentController_VoltageDecouplingEnable	Activation of the voltage decoupling	r/w
990.1	C3.Delay_MasterDelay	Setpoint delay for bus master	r/w
84.4	C3.DeviceSupervision_DeviceAdr	Current RS485 address of the C3M	ro
84.3	C3.DeviceSupervision_DeviceCounter	Number of devices in the C3M combination	ro
84.5	C3.DeviceSupervision_OperatingTime	Hours of operation of the PSUP in s	ro
84.2	C3.DeviceSupervision_ThisDevice	Device number in the C3M combination	ro
85.1	C3.Diagnostics_DeviceState	PSUP operating state	r/w
120.3	C3.DigitalInput_DebouncedValue	Status of digital inputs	ro
550.2	C3.ErrorHistory_1	Error (n-1) in the error history	ro
87.1	C3.ErrorHistoryNumber_1	Error 1	ro
86.1	C3.ErrorHistoryPointer_LastEntry	Pointer to current error	ro
88.1	C3.ErrorHistoryTime_1	Error point in time 1	ro
2020.1	C3.ExternalSignal_Position	Position from external signal source	ro
2010.20	C3.FeedForward_EMF	EMC feed forward	r/w
2011.2	C3.FeedForwardExternal_FilterAccel	External Acceleration Feed Forward Filter Time Constant	r/w
2011.5	C3.FeedForwardExternal_FilterAccel_us	Filter time constant ext. Acceleration	r/w
2011.1	C3.FeedForwardExternal_FilterSpeed	External Speed Feed Forward Filter Time Constant	r/w
2011.4	C3.FeedForwardExternal_FilterSpeed_us	Filter time constant ext. speed	r/w
2240.7	C3.Magnetisierungsstromregler_Bandwidth	Magnetization current controller bandwidth (ASM)	r/w
2240.4	C3.Magnetisierungsstromregler_Damping	Magnetization current controller attenuation(ASM)	r/w
2240.11	C3.Magnetisierungsstromregler_Field weakening speed	Reference speed quantifier (ASM)	r/w
2240.2	C3.Magnetisierungsstromregler_Imrn_DemandValueTuning	Magnetization current quantifier (ASM)	r/w
2240.10	C3.Magnetisierungsstromregler_RotorTimeConstant	Motor Time Constant quantifier	r/w
2240.9	C3.Magnetisierungsstromregler_SlipFrequency	Slip frequency quantifier (ASM)	r/w
2200.3	C3.PositionController_ProportionalPart	Optimization parameters for the position controller P component (KV factor)	r/w
2220.22	C3.Q_CurrentController_BackEMF	Parameter motor force constant	r/w
2220.6	C3.Q_CurrentController_CurrentControlIntegralPart	Current Loop I term	r/w
2220.5	C3.Q_CurrentController_CurrentControlProportionalPart	Current Loop - "P" Term	r/w
2220.20	C3.Q_CurrentController_Inductance	Parameter motor inductance	r/w
2220.21	C3.Q_CurrentController_Resistance	Parameter motor resistance	r/w
2220.27	C3.Q_CurrentController_StructureSelection	Structure switch of current control	r/w
280.5	C3.Resolver_ExcitationLevel	Resolver excitation level	r/w
280.3	C3.Resolver_LevelAdaption	Resolver signal scaling	r/w
2210.17	C3.SpeedController_ActualBandwidth	Replacement time constant for the velocity control	ro
2210.5	C3.SpeedController_I_Part_Gain	Weighting "I" term	r/w
2210.4	C3.SpeedController_P_Part_Gain	P term quantifier	r/w
2120.7	C3.SpeedObserver_DisturbanceAdditionEnable	Switch to enable disturbance compensation	r/w
2120.5	C3.SpeedObserver_DisturbanceFilter	Time constant disturbance filter	r/w
2120.1	C3.SpeedObserver_TimeConstant	Rapidity of the speed monitor	r/w
295.10	C3.SSI_Feedback_Incr_Position	SSI feedback position (Increments)	ro
682.5	C3.StatusAccel_Actual	Status of actual acceleration unfiltered	ro
682.6	C3.StatusAccel_ActualFilter	Status of filtered actual acceleration	ro
682.4	C3.StatusAccel_DemandValue	Status demand acceleration	ro
682.7	C3.StatusAccel_FeedForwardAccel	Status acceleration feed forward	ro
690.5	C3.StatusAutocommutation_Iterations	Current increase steps automatic commutation	ro

Object-No.	Object name	Object	Access
688.2	C3.StatusCurrent_Actual	Status of actual current RMS (torque producing)	ro
688.19	C3.StatusCurrent_ActualDINT	Actual current rms	ro
688.8	C3.StatusCurrent_ControlDeviationIq	Status control deviation current control RMS	ro
688.31	C3.StatusCurrent_DecouplingVoltageUd	Signal decoupling of direct current controller	ro
688.32	C3.StatusCurrent_FeedForwardbackEMF	Signal EMC feed forward	ro
688.14	C3.StatusCurrent_FeedForwardCurrentJerk	Status of current & jerk feedforward	ro
688.34	C3.StatusCurrent_NegativeLimit	Negative current limit effective at present	ro
688.9	C3.StatusCurrent_PhaseU	Status of current phase U	ro
688.10	C3.StatusCurrent_PhaseV	Status of current phase V	ro
688.33	C3.StatusCurrent_PositiveLimit	Positive current limit effective at present	ro
688.1	C3.StatusCurrent_Reference	Status of setpoint current RMS (torque forming)	ro
688.18	C3.StatusCurrent_ReferenceDINT	Demand current rms	ro
688.13	C3.StatusCurrent_ReferenceJerk	Status of demand jerk setpoint generator	ro
688.11	C3.StatusCurrent_ReferenceVoltageUq	Status of current control control signal	ro
688.22	C3.StatusCurrent_ReferenceVoltageVector	Provided voltage pointer	ro
688.30	C3.StatusCurrent_VoltageUd	Provided voltage of direct current controller	ro
688.29	C3.StatusCurrent_VoltageUq	Provided voltage of quadrature current controller	ro
683.2	C3.StatusDevice_ActualDeviceLoad	Status of device load	ro
683.3	C3.StatusDevice_ActualMotorLoad	Status of long-term motor utilization	ro
683.7	C3.StatusDevice_BallastResistorDynamicLoad	Status of short-term braking resistor utilization	ro
683.6	C3.StatusDevice_BallastResistorLoad	Status of long-term braking resistor utilization	ro
683.12	C3.StatusDevice_BallastResistorOFFThreshold	Braking resistor switch-off voltage	ro
683.11	C3.StatusDevice_BallastResistorONThreshold	Braking resistor switch-on voltage	ro
683.5	C3.StatusDevice_ObservedDisturbance	Status of observed disturbance	ro
692.4	C3.StatusFeedback_EncoderCosine	Status of analog input cosine	ro
692.24	C3.StatusFeedback_EncoderCosineVolts	Status of analog input cosine (Volt)	ro
692.3	C3.StatusFeedback_EncoderSine	Status of analog input sine	ro
692.23	C3.StatusFeedback_EncoderSineVolts	Status of analog input sine (Volt)	ro
692.2	C3.StatusFeedback_FeedbackCosineDSP	Status of cosine in signal processing	ro
692.22	C3.StatusFeedback_FeedbackCosineDSPvolts	Status of cosine in signal processing	ro
692.1	C3.StatusFeedback_FeedbackSineDSP	Status of sine in signal processing	ro
692.21	C3.StatusFeedback_FeedbackSineDSPvolts	Status of sine in signal processing	ro
692.5	C3.StatusFeedback_FeedbackVoltage[Vpp]	Status of feedback level	ro
692.10	C3.StatusFeedback_RefChannel	Status feedback index track	ro
692.9	C3.StatusFeedback_ResolverLevel	Status resolver level	ro
699.4	C3.StatusJerk_DemandValue	Status of demand jerk setpoint generator	ro
680.5	C3.StatusPosition_Actual	Status actual position	ro
680.13	C3.StatusPosition_ActualController	Status actual position without absolute reference	ro
680.12	C3.StatusPosition_DemandController	Status demand position without absolute reference	ro
680.4	C3.StatusPosition_DemandValue	Status demand position	ro
680.14	C3.StatusPosition_FeedbackAbsolute	Feedback absolute position in feedback increments	ro
680.6	C3.StatusPosition_FollowingError	Status of tracking error	ro
680.23	C3.StatusPosition_LoadControlActual	Actual position of the load	ro
680.20	C3.StatusPosition_LoadControlDeviation	Position difference load-motor (unfiltered)	ro
680.22	C3.StatusPosition_LoadControlDeviationFiltered	Position difference load-motor (filtered)	ro
681.5	C3.StatusSpeed_Actual	Status actual speed unfiltered	ro
681.9	C3.StatusSpeed_ActualFiltered	Status actual speed filtered	ro
681.12	C3.StatusSpeed_ActualScaled	Filtered actual speed in per cent	ro
681.26	C3.StatusSpeed_ActualUnitrpmORmps	Status of actual speed filtered in 1/min or m/s	ro
681.13	C3.StatusSpeed_DemandScaled	Setpoint speed of the setpoint generator	ro
681.10	C3.StatusSpeed_DemandSpeedController	Status demand speed controller input	ro
681.4	C3.StatusSpeed_DemandValue	Status demand speed of setpoint generator	ro
681.6	C3.StatusSpeed_Error	Status control deviation of speed	ro
681.11	C3.StatusSpeed_FeedForwardSpeed	Status speed feed forward	ro
681.21	C3.StatusSpeed_LoadControlFiltered	Speed of the load feedback (filtered)	ro
681.25	C3.StatusSpeed_NegativeLimit	Negative speed limit currently effective	ro
681.24	C3.StatusSpeed_PositiveLimit	Positive speed limit currently effective	ro
684.2	C3.StatusTemperature_Motor	Status of motor temperature	ro

Object-No.	Object name	Object	Access
684.1	C3.StatusTemperature_PowerStage	Status of power output stage temperature	ro
685.3	C3.StatusVoltage_AnalogInput0	Status of analog input 0	ro
685.4	C3.StatusVoltage_AnalogInput1	Status of analog input 1	ro
685.1	C3.StatusVoltage_AuxiliaryVoltage	Status of auxiliary voltage	ro
685.2	C3.StatusVoltage_BusVoltage	Status DC bus voltage	ro
1901.1	C3Array.Col01_Row01	variable Column 1 Row 1	r/w
1902.1	C3Array.Col02_Row01	variable Column 2 Row 1	r/w
1903.1	C3Array.Col03_Row01	variable Column 3 Row 1	r/w
1904.1	C3Array.Col04_Row01	variable Column 4 Row 1	r/w
1905.1	C3Array.Col05_Row01	variable Column 5 Row 1	r/w
1906.1	C3Array.Col06_Row01	variable Column 6 Row 1	r/w
1907.1	C3Array.Col07_Row01	variable Column 7 Row 1	r/w
1908.1	C3Array.Col08_Row01	variable Column 8 Row 1	r/w
1909.1	C3Array.Col09_Row01	variable Column 9 Row 1	r/w
1910.1	C3Array.Indirect_Col01	indirect table access Column 1	r/w
1900.1	C3Array.Pointer_Row	pointer to table row	r/w
170.3	C3Plus.AnalogInput0_FilterCoefficient	Filter of analog input 0	r/w
171.3	C3Plus.AnalogInput1_FilterCoefficient	Filter of analog input 1	r/w
2190.2	C3Plus.AutoCommutationControl_InitialCurrent	Start current of automatic commutation	r/w
2190.4	C3Plus.AutoCommutationControl_MotionReduction	Motion reduction Automatic commutation	r/w
2190.8	C3Plus.AutoCommutationControl_PeakCurrent	Reduction of the peak current	r/w
2190.3	C3Plus.AutoCommutationControl_PositionThreshold	Motion limit for automatic commutation	r/w
2190.1	C3Plus.AutoCommutationControl_Ramptime	Ramp slope current slope AK	r/w
2190.10	C3Plus.AutoCommutationControl_Reset	Reset automatic commutation	r/w
2190.7	C3Plus.AutoCommutationControl_StandstillThreshold	Optimization of the standstill threshold	r/w
1100.3	C3Plus.DeviceControl_Controlword_1	STW control word	r/w
1000.3	C3Plus.DeviceState_Statusword_1	status word ZSW	r/w
1000.4	C3Plus.DeviceState_Statusword_2	Status word 2	r/w
85.8	C3Plus.Diagnostics_ChopperOff_Voltage	Chopper Switch-off threshold in V	ro
85.7	C3Plus.Diagnostics_ChopperOn_Voltage	Chopper Switch-on threshold in V	ro
85.3	C3Plus.Diagnostics_DCbus_Current	PSUP intermediate current	ro
85.2	C3Plus.Diagnostics_DCbus_Voltage	PSUP DC intermediate voltage	ro
85.9	C3Plus.Diagnostics_DCbus_VoltageMax	Reduced DC bus voltage in V	ro
85.5	C3Plus.Diagnostics_RectifierLoad	PSUP usage in %	ro
85.4	C3Plus.Diagnostics_TemperatureHeatSink	PSUP heat dissipator temperature	ro
620.6	C3Plus.EncoderEmulation_Offset	Zero pulse offset encoder emulation	r/w
620.7	C3Plus.EncoderEmulation_SetEmulationZero	Encoder simulation teaching zero pulse	r/w
620.10	C3Plus.EncoderEmulation_Setpoint_without_offset	Demand position of encoder simulation (without offset)	ro
550.1	C3Plus.ErrorHistory_LastError	current error (n)	ro
2020.7	C3Plus.ExternalSignal_Accel_Munits	Acceleration of the external signal source	ro
2020.6	C3Plus.ExternalSignal_Speed_Munits	Speed value of the external signal source	ro
3920.7	C3Plus.HEDA_SignalProcessing_OutputGreat	Output of the Heda Tracking Filter	ro
1130.13	C3Plus.HOMING_edge_position	Distance MN (zero) initiator - motor zero	r/w
2201.2	C3Plus.LoadControl_Command	Load control command mode	r/w
2201.1	C3Plus.LoadControl_Enable	Activate load control	r/w
2201.11	C3Plus.LoadControl_FilterLaggingPart	Time constant of position difference filter	r/w
2201.3	C3Plus.LoadControl_Status	Load control status bits	ro
2201.12	C3Plus.LoadControl_VelocityFilter	Time constant of the load-speed filter	r/w
2201.13	C3Plus.LoadControl_VelocityLimit	Load control intervention speed limitation	r/w
2150.2	C3Plus.NotchFilter_BandwidthFilter1	Bandwidth of notch filter 1	r/w
2150.5	C3Plus.NotchFilter_BandwidthFilter2	Bandwidth of notch filter 2	r/w
2150.3	C3Plus.NotchFilter_DepthFilter1	Depth of notch filter 1	r/w
2150.6	C3Plus.NotchFilter_DepthFilter2	Depth of notch filter 2	r/w
2150.1	C3Plus.NotchFilter_FrequencyFilter1	Center frequency of notch filter 1	r/w
2150.4	C3Plus.NotchFilter_FrequencyFilter2	Center frequency of notch filter 2	r/w
1252.20	C3Plus.PG2RegMove_ParametersModified	Status RegMove	r/w
1111.3	C3Plus.POSITION_accel	Acceleration for positioning	r/w
1111.4	C3Plus.POSITION_decel	Deceleration for positioning	r/w
1111.5	C3Plus.POSITION_jerk_accel	Acceleration jerk for positioning	r/w

Object-No.	Object name	Object	Access
1111.6	C3Plus.POSITION_jerk_decel	Deceleration jerk for positioning	r/w
1111.1	C3Plus.POSITION_position	Target position	r/w
1111.2	C3Plus.POSITION_speed	Speed for positioning	r/w
2200.20	C3Plus.PositionController_DeadBand	Deadband of position controller	r/w
2200.21	C3Plus.PositionController_FrictionCompensation	Friction compensation	r/w
2200.25	C3Plus.PositionController_IntegralPart	I term of position controller	r/w
2200.11	C3Plus.PositionController_TrackingErrorFilter	Following error filter of the position controller	r/w
2200.24	C3Plus.PositionController_TrackingErrorFilter_us	Time constant following error filter of position controller	r/w
1152.20	C3Plus.RegMove_ParametersModified	Status RegMove	r/w
295.12	C3Plus.SSI_Feedback_PositionGreat	Rotation position	ro
688.17	C3Plus.StatusCurrent_FieldWeakeningFactor	Reciprocal of the field weakening factor FF	ro
684.4	C3Plus.StatusTemperature_TmotResistance	Status of motor temperature resistance value	ro
670.4	C3Plus.StatusTorqueForce_ActualForce	Status of actual force	ro
670.2	C3Plus.StatusTorqueForce_ActualTorque	Status of actual torque	ro
110.1	C3Plus.Switch_DeviceFunction	Value of the function switch on C3M	ro
3300.9	C3Plus.TouchProbe_IgnoreZone_End	End of Registration lock-out zone (StopIgnore)	r/w
3300.8	C3Plus.TouchProbe_IgnoreZone_Start	Beginning of Registration lock-out zone (StartIgnore)	r/w
2109.1	C3Plus.TrackingfilterHEDA_TRFSpeed	Time constant tracking filter HEDA-process position	r/w
2107.1	C3Plus.TrackingfilterPhysicalSource_TRFSpeed	Time constant tracking filter physical source	r/w
2110.4	C3Plus.TrackingfilterSG1_AccelFilter	Filter effect of acceleration filter setpoint encoder	r/w
2110.7	C3Plus.TrackingfilterSG1_AccelFilter_us	Filter time constant acceleration setpoint generator	r/w
2110.3	C3Plus.TrackingfilterSG1_FilterSpeed	Filter effect of speed filter setpoint encoder	r/w
2110.6	C3Plus.TrackingfilterSG1_FilterSpeed_us	Filter time constant velocity setpoint generator	r/w
2110.1	C3Plus.TrackingfilterSG1_TRFSpeed	Time constant tracking filter setpoint encoder	r/w
634.6	.AnalogOutput0_Offset_Hardware	Offset value for the D/A monitor 0	r/w
635.6	.AnalogOutput1_Offset_Hardware	Offset value for the D/A Monitor 1	r/w
170.2	C3.AnalogInput0_Gain	Gain analog input 0	r/w
170.4	C3.AnalogInput0_Offset	Analog input Offset 0	r/w
171.2	C3.AnalogInput1_Gain	Gain analog input 1	r/w
171.4	C3.AnalogInput1_Offset	Analog input offset 1	r/w
634.7	C3.AnalogOutput0_Gain_Hardware	Additional gain factor for the D/A monitor 0	r/w
635.7	C3.AnalogOutput1_Gain_Hardware	Additional gain factor for the D/A monitor 1	r/w

A detailed object list can be found in the corresponding online help.

7. Status values

In this chapter you can read about:

D/A-Monitor 300

A list of the status values supports you in optimization and commissioning. Open the optimization function in the C3 ServoManager (double-click on optimization in the tree)

You will find the available status values in the lower right part of the window under selection (TAB) "Status values".

You can pull them into the oscilloscope (upper part of the left side) or into the status display (upper part of the right side) by the aid of the mouse (drag and drop).

The status values are divided into 2 groups (user levels):

standard: here you can find all important status values

advanced: Advanced status values, require a better knowledge

Switching of the user level

The user level can be changed in the optimization window (left hand side lower part under selection (TAB) "optimization") with the following button.

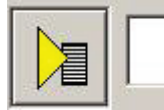

7.1 D/A-Monitor

A part of the status values can be output via the D/A monitor channel 0 (X11/4) and channel 1 (X11/3). In the following status list under D/A monitor output: possible / not possible).

The reference for the output voltage can be entered individually in the reference unit of the status value.

Example: Output Object 2210.2: (actual speed unfiltered)

In order to get an output voltage of 10V at 3000prpm , please enter rev/s (=3000rpm) as "value of the signal at 10V".

Hint

The unit of measurement of the D/A monitor values differs from the unit of measurement of the status values.

Additional information on the topic of "status values" can be found in the online help of the device.

8. Error

Standard error reactions:

Reaction 2: Downramp with "de-energize" then **apply brake** (see on page 268) and finally de-energize.

For errors with standard reaction 2 the **error reaction can be changed** (see on page 147).

Reaction 5: de-energize immediately (without ramps), apply brake.

Caution! A Z-axis may drop down due to the brake delay times

Pending errors can be acknowledged with Quit!

**Object 550.1 displays error:
value 1 means "no error".**

The errors as well as the error history can be viewed in the C3 ServoManager under optimization (at the top right of the optimization window).

Detailed information on the topic of the "error list" can be found in the online help of the device.

9. Order code

In this chapter you can read about:

Order code device: Compax3	303
Order code for mains module: PSUP	304
Order code for accessories	304

9.1 Order code device: Compax3

Example: C3S025V2F10I10T10M00



Device type: Compax3

Single axis	S									--
Highpower	H									--
Multi-axis device	M									

Device currents static/dynamic; supply voltage

2.5A / 5A ; 230VAC (single phase)	S	025	V2							--
6.3 A / 12.6 A ; 230VAC (1 phase)	S	063	V2							--
10A / 20A ; 230VAC (three phase)	S	100	V2							--
15A / 30A ; 230VAC (three phase)	S	150	V2							--
1.5A / 4.5A ; 400VAC (three phase)	S	015	V4							--
3.8 A / 7.5 A ; 400VAC (3 phase)	S	038	V4							--
7.5 A / 15.0 A ; 400VAC (3 phase)	S	075	V4							--
15.0 A / 30.0 A ; 400VAC (3 phase)	S	150	V4							--
30.0 A / 60.0 A ; 400VAC (3 phase)	S	300	V4							--
50A / 75A ; 400VAC (three phase)	H	050	V4							--
90A / 135A ; 400VAC (three phase)	H	090	V4							--
125A / 187.5A ; 400VAC (three phase)*	H	125	V4							--
155A / 232.5A ; 400VAC (three phase)*	H	155	V4							--
5.0A / 10,0A ; 400VAC (three phase)	M	050	D6							
10A / 20A ; 400VAC (three phase)	M	100	D6							
15A / 30A ; 400VAC (three phase)	M	150	D6							
60A 30A / ; 400VAC (three phase)	M	300	D6							

Feedback:

Resolver										F10
SinCos© (Hiperface)										F11
Encoder, Sine-cosine with/without hall										F12

Interface:

Step/direction / analogue input										I10	T10	M00
Positioning with inputs/outputs										I11	T11	M00
Positioning via I/Os or RS232 / RS485/USB										I12		
Profibus DP V0/V1/V2 (12Mbaud)										I20		
CANopen										I21		
DeviceNet										I22		
Ethernet Powerlink										I30		
EtherCAT										I31		
Profinet										I32		
C3 powerPLmC (Multi-axis control)										C20		M00

Technology functions:

Positioning												T11
Motion control programmable according to IEC61131-3												T30
Motion control programmable according to IEC61131-3 & electronic cam extension												T40

Options:

no additional supplement													M00
Expansion 12 digital I/Os & HEDA (Motionbus)													M10
HEDA (Motionbus)													M11
Expansion, 12 digital I/Os													M12

Safety technology only C3M:

Safe torque off	M		D6										S1
Extended safety technology	M		D6										S3

*external voltage supply for ventilator fan required. Available in two versions for single phase feed:

Standard: 220/240VAC: 140W, on request: 110/120VAC: 130W

9.2 Order code for mains module: PSUP

Example: PSUP10D6USBM00

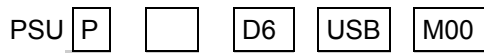

Power module	P				
Nominal power; supply voltage					
10kW; 400 VAC (3-phase)		10	D6		
20kW; 400 VAC (3-phase)		20	D6		
30kW; 400 VAC (3-phase)		30	D6		
Interface:					
USB connection				USB	
Options:					
no additional supplement					M00

9.3 Order code for accessories

In this chapter you can read about:

Order code for feedback cables	305
Order Code braking resistors	305
Order code mains filter (C3S)	306
Order code capacitor module	306
Interface cable order code	306
Order Code input/output terminals (PIO)	307
Order note	308

Order Code connection set for Compax3S

The corresponding connection sets are furnished with the device.

for C3S0xxV2	ZBH 02/01	ZBH	0 2 / 0 1		
for C3S0xxV4 / S150V4 / S1xxV2	ZBH 02/02	ZBH	0 2 / 0 2		
for C3S300V4	ZBH 02/03	ZBH	0 2 / 0 3		

Order code for PSUP/Compax3M connection set

The corresponding connection sets are furnished with the device.

for C3M050D6, C3M100D6, C3M150D6	ZBH 04/01	ZBH	0 4 / 0 1		
for C3M300D6	ZBH 04/02	ZBH	0 4 / 0 2		
for PSUP10	ZBH 04/03	ZBH	0 4 / 0 3		
PSUP20, PSUP30	ZBH 04/04	ZBH	0 4 / 0 4		

9.3.1. Order code for feedback cables

for resolver ⁽²⁾	for MH / SMH motors		REK	4 2	/ ⁽¹⁾
for resolver ⁽²⁾	for MH / SMH motors	(cable chain compatible)	REK	4 1	/ ⁽¹⁾
for SinCos© – feedback ⁽²⁾	for MH / SMH motors	(cable chain compatible)	GBK	2 4	/ ⁽¹⁾
for EnDat 2.1 ⁽²⁾	for MH / SMH motors	(cable chain compatible)	GBK	3 8	/ ⁽¹⁾
for EnDat 2.2 ⁽²⁾	for MH / SMH motors	(cable chain compatible)	GBK	5 6	/ ⁽¹⁾
Encoder – Compax3			GBK	2 3	/ ⁽¹⁾
for LXR linear motors		(cable chain compatible)	GBK	3 3	/ ⁽¹⁾
for BLMA linear motors		(cable chain compatible)	GBK	3 2	/ ⁽¹⁾

^(x) **Note on cable** (see on page 308)

Motor cable order code ⁽²⁾

for SMH / MH56 / MH70 / MH105 ⁽³⁾	(1.5mm ² ; up to 13.8A)		MOK	5 5	/ ⁽¹⁾
for SMH / MH56 / MH70 / MH105 ⁽³⁾	(1.5mm ² ; up to 13.8A)	(cable chain compatible)	MOK	5 4	/ ⁽¹⁾
for SMH / MH56 / MH70 / MH105 ⁽³⁾	(2.5mm ² ; up to 18.9A)		MOK	5 6	/ ⁽¹⁾
for SMH / MH56 / MH70 / MH105 ⁽³⁾	(2.5mm ² ; up to 18.9A)	(cable chain compatible)	MOK	5 7	/ ⁽¹⁾
for MH145 / MH205 ⁽⁴⁾	(1.5mm ² ; up to 13.8A)		MOK	6 0	/ ⁽¹⁾
for MH145 / MH205 ⁽⁴⁾	(1.5mm ² ; up to 13.8A)	(cable chain compatible)	MOK	6 3	/ ⁽¹⁾
for MH145 / MH205 ⁽⁴⁾	(2.5mm ² ; up to 18.9A)		MOK	5 9	/ ⁽¹⁾
for MH145 / MH205 ⁽⁴⁾	(2.5mm ² ; up to 18.9A)	(cable chain compatible)	MOK	6 4	/ ⁽¹⁾
for MH145 / MH205 ⁽⁴⁾	(6mm ² ; up to 32.3A)	(cable chain compatible)	MOK	6 1	/ ⁽¹⁾
for MH145 / MH205 ⁽⁴⁾	(10mm ² ; up to 47.3A)	(cable chain compatible)	MOK	6 2	/ ⁽¹⁾

^(x) **Note on cable** (see on page 308)

9.3.2. Order Code braking resistors

Order Code braking resistors

for C3S063V2 or C3S075V4	56Ω / 0.18kW _{cont.}		BRM	0 5	/	0 1	
for C3S075V4	56Ω / 0.57kW _{cont.}		BRM	0 5	/	0 2	
for C3S025V2 or C3S038V4	100Ω / 60W _{cont.}		BRM	0 8	/	0 1	
for C3S150V4	47Ω / 0.57kW _{cont.}		BRM	1 0	/	0 1	
for C3S150V2, C3S300V4 and PSUP20D6	4/01:15Ω / 0.57kW _{cont.} 4/02:15Ω / 0.74kW _{cont.}		BRM	0 4	/	0 ...	
for C3S300V4 and PSUP20D6	4/03:15Ω / 1.5kW _{cont.}						
for C3S100V2	22Ω / 0.45kW _{cont.}		BRM	0 9	/	0 1	
for C3H0xxV4	27Ω / 3.5kW _{cont.}		BRM	1 1	/	0 1	
for PSUP10D6 and PSUP20D6 / PSUP30D6 (2x30Ω parallel)	30Ω / 0.5kW _{cont.}		BRM	1 3	/	0 1	
for PSUP10D6 (2x15Ω in series), PSUP20D6, PSUP30D6	15Ω / 0.5kW _{cont.}		BRM	1 4	/	0 1	
for C3H1xxV4, PSUP30D6	18Ω / 4.5kW _{cont.}		BRM	1 2	/	0 1	

9.3.3. Order code mains filter (C3S)

Order code mains filter Compax3S

for C3S025V2 or S063V2	NFI	0	1	/	0 1
for C3S0xxV4, S150V4 or S1xxV2	NFI	0	1	/	0 2
for C3S300V4	NFI	0	1	/	0 3

Order code mains filter Compax3H

for C3H050V4	NFI	0	2	/	0 1
for C3H090V4	NFI	0	2	/	0 2
for C3H1xxV4	NFI	0	2	/	0 3

Order Code mains filter PSUP

for PSUP10	Reference axis combination 3x480V 25A 6x10m motor cable length	NFI	0	3	/ 0 1
for PSUP10	Reference axis combination 3x480V 25A 6x50m motor cable length	NFI	0	3	/ 0 2
for PSUP20 & PSUP30	Reference axis combination 3x480V 50A 6x50m motor cable length	NFI	0	3	/ 0 3

Order code for mains filters

for PSUP30	Mains filter	LCG-0055-0.45 mH
for PSUP30	Mains filter with UL approval	LCG-0055-0.45 mH-UL

Order code for motor output filter (for Compax3S, Compax3M >20m motor cable)

up to 6,3 A rated motor current	MDR	0	1	/	0 4
Up to 16 A rated motor current	MDR	0	1	/	0 1
Up to 30A A rated motor current	MDR	0	1	/	0 2

9.3.4. Order code capacitor module

Order code capacitor module

for C3S300V4	1100µF	Module	C4
--------------	--------	--------	----

9.3.5. Interface cable order code

Order code for interface cables and connectors

PC – Compax3 (RS232)	SSK	0	1	/ ⁽¹⁾
PC – PSUP (USB)	SSK	3	3	/
on X11 (Ref/Analog) and X13 with C3F001D2	SSK	2	1	/ ⁽¹⁾
on X12 / X22 (digital I/Os)	SSK	2	2	/ ⁽¹⁾
on X11 (Ref /Analog)	SSK	2	3	/ ⁽¹⁾
on X12 / X22 (digital I/Os)	SSK	2	4	/ ⁽¹⁾
PC ⇔ POP (RS232)	SSK	2	5	/ ⁽¹⁾
Compax3 ⇔ POP (RS485) for several C3H on request	SSK	2	7	/	.. / ... ⁽⁶⁾
Compax3 HEDA ⇔ Compax3 HEDA or PC ⇔ C3powerPLmC	SSK	2	8	/	.. / ... ⁽⁵⁾
Compax3 I30 ⇔ Compax3 I30 or C3M-multi-axis communication	SSK	2	9	/ ⁽¹⁾
Profinet, EtherCAT, Ethernet Powerlink	SSK	3	1	/
Compax3 X11 ⇔ Compax3 X11 (encoder coupling of 2 axes)	SSK	3	2	/	2 0
Compax3 X10 ⇔ Modem	SSK	1	7	/	0 1
Compax3H adapter cable ⇔ SSK01 (length 15cm, delivered with the device)	VBK	0	7	/	0 1
Compax3H X10 RS232 connection control ⇔ Programming interface (delivered with the device)	BUS	0	7	/	0 1
Bus terminal connector (for the 1st and last Compax3 in the HEDA Bus/or multi-axis system)	BUS	0	7	/	0 1
Profibus cable ⁽²⁾	SSL	0	1	/ ⁽⁷⁾
Profibus connector	BUS	0	8	/	0 1
CAN bus cable ⁽²⁾	SSL	0	2	/ ⁽⁷⁾
CAN bus connector	BUS	1	0	/	0 1

^(x) Note on cable (see on page 308)

Order Code operating module

Operating module (for Compax3S and Compax3F)	BDM	0	1	/	0 1
--	-----	---	---	---	-----

Order Code terminal block

for I/Os without luminous indicator	EAM	0	6	/	0 1
for I/Os with luminous indicator	EAM	0	6	/	0 2

9.3.6. Order Code input/output terminals (PIO)

Order Code decentralized input terminals

PIO 2DI 24VDC 3.0ms	PIO	4	0	0
PIO 4DI 24VDC 3.0ms	PIO	4	0	2
PIO 8DI 24VDC 3.0ms	PIO	4	3	0
PIO 2AI DC ±10V differential input	PIO	4	5	6
PIO 4AI 0-10VDC S.E.	PIO	4	6	8
PIO 2AI 0-20mA differential input	PIO	4	8	0

Order Code decentralized output terminals

PIO 2DO 24VDC 0.5A	2 channel digital output terminal (output voltage 0.5A)	PIO	5	0	1	
PIO 4DO 24VDC 0.5A	4 channel digital output terminal (output voltage 0.5A)	PIO	5	0	4	
PIO 8DO 24VDC 0.5A	8 channel digital output terminal (output voltage 0.5A)	PIO	5	3	0	
PIO 2AO 0-10VDC	2 channel analog output terminal (0-10V signal voltage)	PIO	5	5	0	
PIO 2AO 0-20mA	2-channel analog output terminal (0-20mA signal voltage)	PIO	5	5	2	
PIO 2AO DC ±10V	2-channel analog output terminal (±10V signal voltage)	PIO	5	5	6	

Order Code CANopen Fieldbus Coupler

CANopen Standard	max. Vectorial sum current for bus terminals 1650mA at 5V	PIO	3	3	7	
CANopen ECO	max. Vectorial sum current for bus terminals 650mA at 5V	PIO	3	4	7	

9.3.7. Order note

¹ Length code 1

Length [m]	1.0	2.5	5.0	7.5	10.0	12.5	15.0	20.0	25.0	30.0	35.0	40.0	45.0	50.0
Code	01	02	03	04	05	06	07	08	09	10	11	12	13	14

Other adaptation can be developed on request!

Example:

SSK01/09: Length 25m

² Colors according to DESINA

³ with motor connector

⁴ with cable eye for motor terminal box

⁵ length code 2 for SSK28

Length [m]	0.17	0.25	0.5	1.0	3.0	5.0	10.0
Order code	23	20	21	01	22	03	05

⁶ Order code: **SSK27/nn/..**

Length A (Pop - 1. Compax3) variable (the last two numbers according to the length code for cable, for example SSK27/nn/01)

Length B (1. Compax3 - 2. Compax3 - ... - n. Compax3) fixed 50 cm (only if there is more than 1 Compax3, i.e. nn greater than 01)

Number n (the last two digits)

Examples include:

SSK27/05/.. for connecting from Pop to 5 Compax3.

SSK27/01/.. for connecting from Pop to one Compax3

MOK55 and MOK54 can also be used for linear motors LXR406, LXR412 and BLMA.

⁷ sold by the meter: Length in meters (order in number of items)

⁸ **Note on cable** (see on page 308)

10. Compax3 Accessories

In this chapter you can read about:

Parker servo motors	309
EMC measures.....	312
Connections to the motor.....	320
External braking resistors	325
Capacitor module C4	338
Operator control module BDM	339
EAM06: terminal block for inputs and outputs	339
Interface cable.....	342
Options M1x	347

10.1 Parker servo motors

In this chapter you can read about:

Direct drives	309
Rotary servo motors	311

10.1.1. Direct drives

In this chapter you can read about:

Transmitter systems for direct drives	310
Linear motors	311
Torque motors	311

10.1.1.1 Transmitter systems for direct drives

The Feedback option F12 makes it possible to operate linear motors as well as torque motors. Compax3 supports the following transmitter systems:

Special Feedback Systems	Option F12
Analog hall sensors	<ul style="list-style-type: none"> ◆ Sine-Cosine signal (max. 5Vpp*; typical 1Vpp) 90° offset ◆ U-V signal (max. 5Vpp*; typical 1Vpp) 120° offset.
Encoder (linear or rotary)	<ul style="list-style-type: none"> ◆ Sine-Cosine (max. 5Vpp*; typical 1Vpp) (max. 400kHz) or ◆ TTL (RS422) (max. 5MHz; track A or B) ◆ Bypass function for encoder signals (limit frequency** 5MHz, track A or B) with the following modes of commutation: <ul style="list-style-type: none"> ◆ Automatic commutation (see on page 310) or ◆ U, V, W or R, S, T commutation signals (NPN open collector) e.g. digital hall sensors, incremental encoders made by Hengstler (F series with electrical ordering variant 6)
EnDat*** with incremental (Sine - Cosine) track	<ul style="list-style-type: none"> ◆ EnDat 2.1 or EnDat 2.2 (Endat01, Endat02) feedback ◆ linear or rotary ◆ max. 400kHz Sine-Cosine
EnDat 2.2*** (fully digital)	<ul style="list-style-type: none"> ◆ EnDat 2.2 (Endat01, Endat02) feedback ◆ linear or rotary ◆ max. Cable length: 25 m
EnDat2.1*** (fully digital)	<ul style="list-style-type: none"> ◆ EnDat 2.1 without incremental track ◆ Supported types: EQI11xx, ECI11xx, ECI11x ◆ max. Cable length: 90 m
Distance coded feedback systems	<ul style="list-style-type: none"> ◆ Distance coding with 1 VSS interface ◆ Distance coding with RS422 - Interface (Encoder)

*Max. differential input between SIN- (X13/7) and SIN+ (X13/8).

** Limit frequency = 1MHz for Compax3M (higher bandwidths on request)

*** Digital, bidirectional interface

The motor performs automatic commutation after:

- ◆ Power on,
- ◆ A configuration download or
- ◆ An IEC program download

The time duration (typically 5-10 sec) of automatic commutation can be optimized with the start current (see in the optimization display of the C3 ServoManager; given as a percentage of the reference current). Note that values that are too high will cause Error 0x73A6 to be triggered.

Typically the motor moves by 4% of the pitch length or, with rotary direct drives 4% of 360°/number of pole pairs - maximum 50%.

Note the following conditions for automatic commutation

- ◆ During automatic commutation the end limits are not monitored.
- ◆ Actively working load torques are not permitted during automatic commutation.
- ◆ Static friction deteriorates the effect of automatic commutation.
- ◆ With the exception of missing commutation information, the controller/motor combination is configured and ready for operation (parameters correctly assigned for the linear motor/drive). The transmitter and the direction of the field of rotation in effect must match.
- ◆ The auto-commutating function must be adapted to fit the mechanics if necessary during commissioning.

10.1.1.2 Linear motors

Parker offers you a number of systems of linear motor drives:

Linear motors	Feed force (continuous/dynamic)	Stroke length:
LMDT ironless linear servo motors:	26 ... 1463N	almost any
LMI iron-cored linear servo motors:	52 ... 6000N	64 ... 999mm
LXR Series Linear Motors	315N / 1000N	up to 3m
Linear motor module BLMA:	605N / 1720N	up to 6m

10.1.1.3 Torque motors

Parker offers you an extensive range of torque motors that can be adapted to your application. Please contact us for information.

Additional information can be found on the **Internet** <http://www.parker.com/eme> in the direct drives section.

10.1.2. Rotary servo motors

Parker offers you an extensive range of servo motors that can be adapted to your application. Please contact us for information.

Additional information can be found on the **Internet** <http://www.parker.com/eme/smh> or on the DVD supplied in the documentations file.

Suitable servo motors for Compax3H are available on request!

10.2 EMC measures

In this chapter you can read about:

Mains filter312
 Motor output filter.....317
 Mains chokes319

10.2.1. Mains filter

For radio disturbance suppression and for complying with the emission limit values for CE conform operation we offer mains filters:

Observe the maximum permitted length of the connection between the mains filter and the device:

- ◆ unshielded <0.5m;
- ◆ shielded: <5m (fully shielded on ground e.g. ground of control cabinet)

Order code mains filter Compax3S

for C3S025V2 or S063V2	NFI	0	1	/	0 1
for C3S0xxV4, S150V4 or S1xxV2	NFI	0	1	/	0 2
for C3S300V4	NFI	0	1	/	0 3

Order Code mains filter PSUP

for PSUP10	Reference axis combination 3x480V 25A 6x10m motor cable length	NFI	0	3	/ 0 1
for PSUP10	Reference axis combination 3x480V 25A 6x50m motor cable length	NFI	0	3	/ 0 2
for PSUP20 & PSUP30	Reference axis combination 3x480V 50A 6x50m motor cable length	NFI	0	3	/ 0 3

Order code for mains filters

for PSUP30	Mains filter	LCG-0055-0.45 mH
for PSUP30	Mains filter with UL approval	LCG-0055-0.45 mH-UL

Order code mains filter Compax3H

for C3H050V4	NFI	0	2	/	0 1
for C3H090V4	NFI	0	2	/	0 2
for C3H1xxV4	NFI	0	2	/	0 3

10.2.1.1 Mains filter NFI01/01

for Compax3 S025 V2 and Compax3 S063 V2

Dimensional drawing:

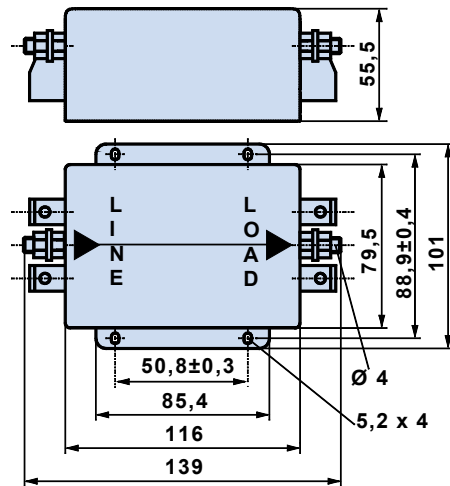

10.2.1.2 Mains filter NFI01/02

for Compax3 S0xx V4, Compax3 S150 V4 and Compax3 S1xx V2

Dimensional drawing:

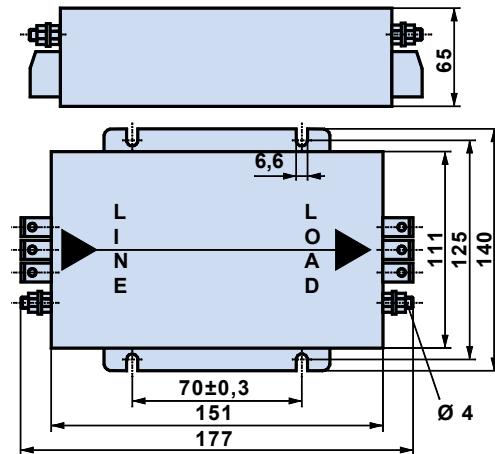

Stated in mm

10.2.1.3 Mains filter for NFI01/03

for Compax3 S300

Dimensional drawing:

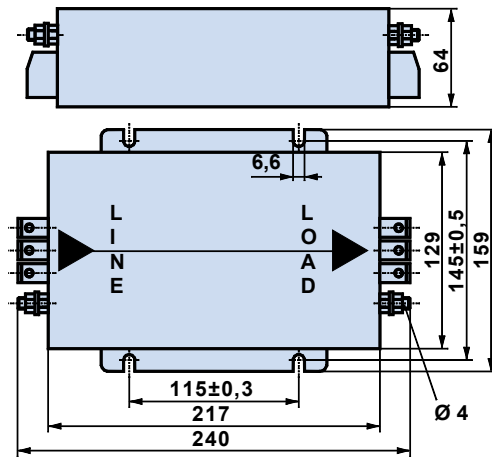

Stated in mm

10.2.1.4 Mains filter NFI02/0x

Filter for mounting below the Compax3 Hxxx V4 housing

Dimensional drawing:

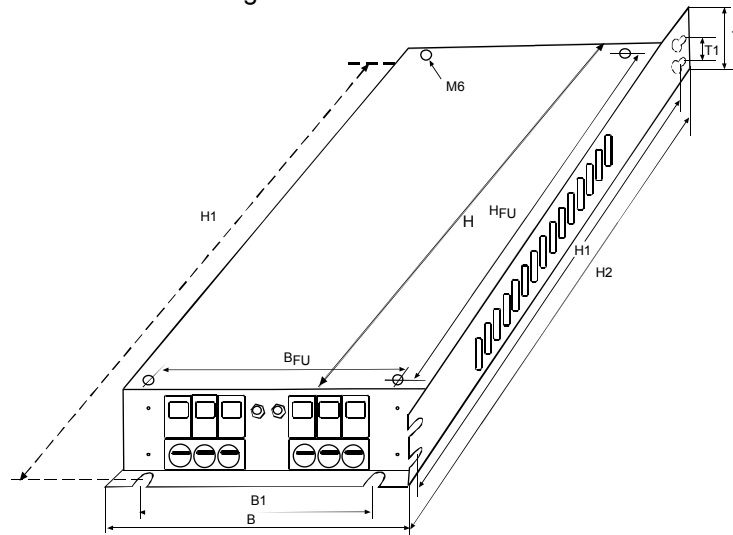

	Filter type	Dimensions				Fixing Centers			Distances		Weight	Grounding clamp	Connection clamp
		W	H2	H	D	W1	H1	D1	BFU	HFU			
		mm				mm			mm		kg		
C3H050V4	NFI02/01	233	515	456	70	186	495	40	150	440	4.3	M6	16mm ²
C3H090V4	NFI02/02	249	715	649	95	210	695	40	150	630	8.5	M8	50mm ²
C3H1xxV4	NFI02/03	249	830	719	110				150	700	15.0	M10	95mm ²

10.2.1.5 Mains filter NFI03/01& NFI03/03

for PSUP10D6 and PSUP20D6

Dimensional drawing:

Bottom view

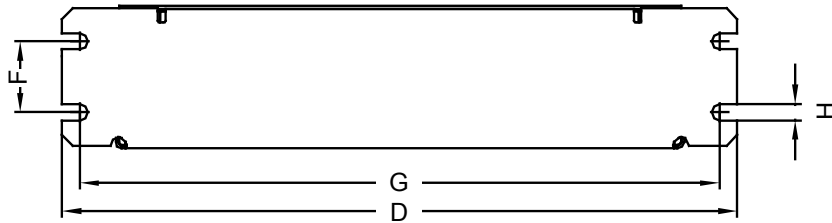

Side view

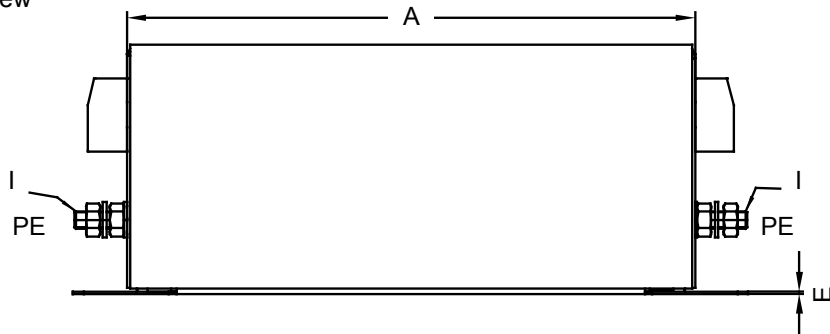

Front view

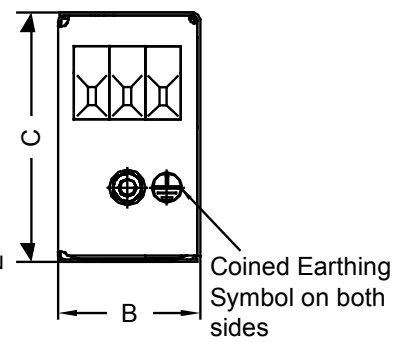

Top view

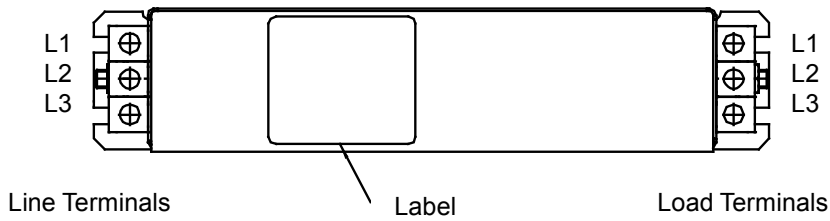

Filter type									Weight	GND(I)	Connection clamp
	A	B	C	D	I	F	G	H			
NFI03/01	240	50	85	270	0.8	30	255	5.4	1.5	M5	10mm ²
NFI03/03	220	85	90	250	1.0	60	235	5.4	2.4	M6	16mm ²

Stated in mm

10.2.1.6 Mains filter NFI03/02

for PSUP10D6

Dimensional drawing:

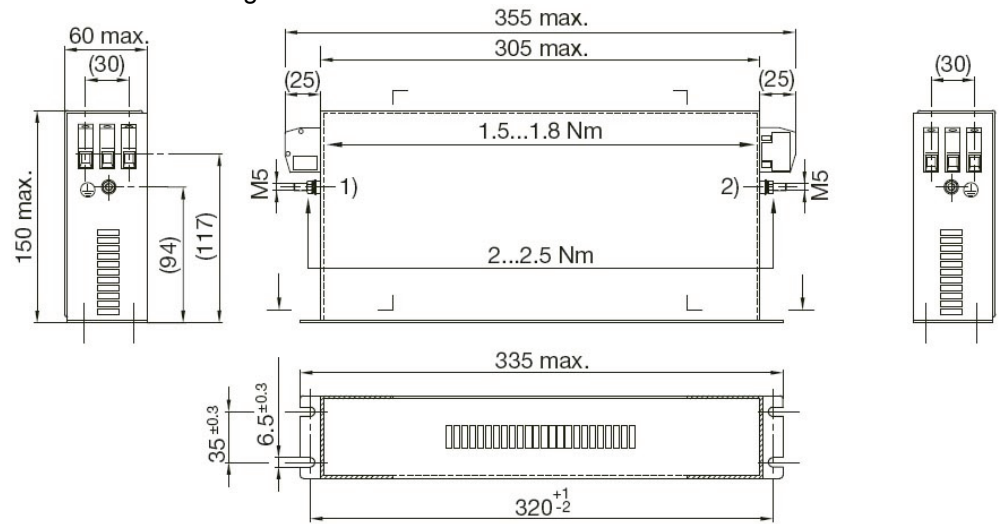

10.2.2. Motor output filter

We offer motor output filters for disturbance suppression when the motor connecting cables are long (>20m):

Order code for motor output filter (for Compax3S, Compax3M >20m motor cable)

	<input type="text"/>	<input type="text"/>	/	<input type="text"/>	<input type="text"/>
up to 6,3 A rated motor current	MDR	0	1	/	0 4
Up to 16 A rated motor current	MDR	0	1	/	0 1
Up to 30A A rated motor current	MDR	0	1	/	0 2

Larger motor output filters are available on request!

In this chapter you can read about:

Motor output filter MDR01/04.....	317
Motor output filter MDR01/01.....	317
Motor output filter MDR01/02.....	318
Wiring of the motor output filter.....	318

10.2.2.1 Motor output filter MDR01/04

up to 6.3A nominal motor current (3.6mH)

Dimensional drawing:

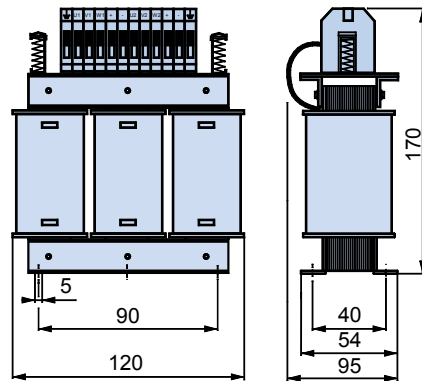

Stated in mm

10.2.2.2 Motor output filter MDR01/01

Up to 16 A nominal motor current (2mH)

Dimensional drawing:

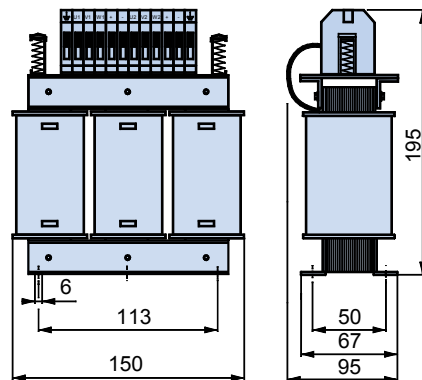

Stated in mm

10.2.2.3 Motor output filter MDR01/02

up to 30A nominal motor current (1.1mH)

Dimensional drawing:

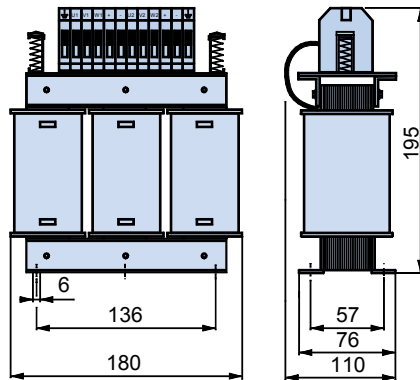

Weight: 5.8kg

Stated in mm

10.2.2.4 Wiring of the motor output filter

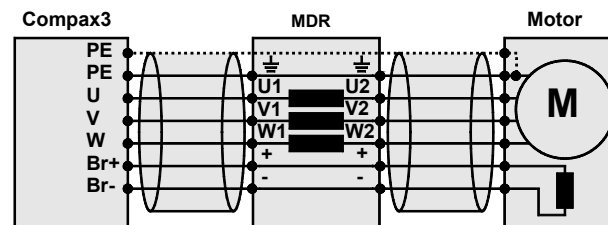

10.2.3. Mains chokes

Mains filters serve for reducing the low-frequency interferences on the mains side.

10.2.3.1 Mains filter for PSUP30

Required mains filter for the PSUP30: 0.45 mH / 55 A

We offer the following mains filters:

- ◆ LCG-0055-0.45 mH (WxDxH: 180 mm x 140 mm x 157 mm; 10 kg)
- ◆ LCG-0055-0.45 mH-UL (with UL approval) (WxDxH: 180 mm x 170 mm x 157 mm; 15 kg)

Dimensional drawing: LCG-0055-0.45 mH

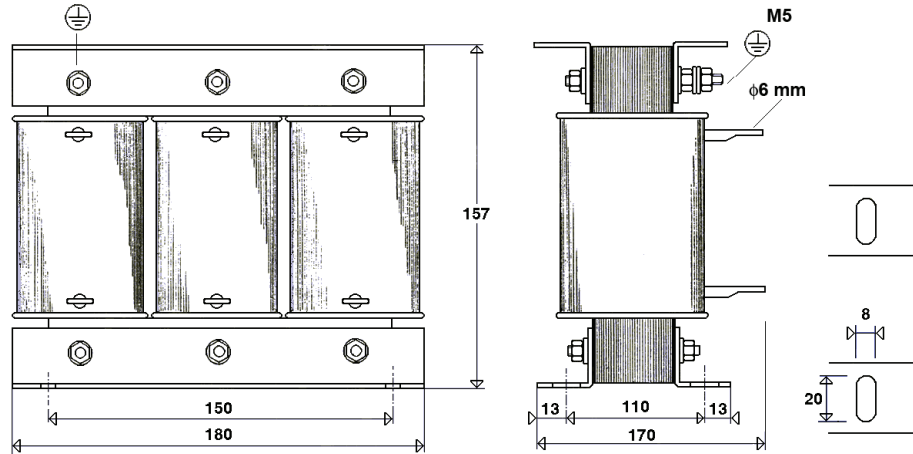

Dimensional drawing: LCG-0055-0.45 mH-UL

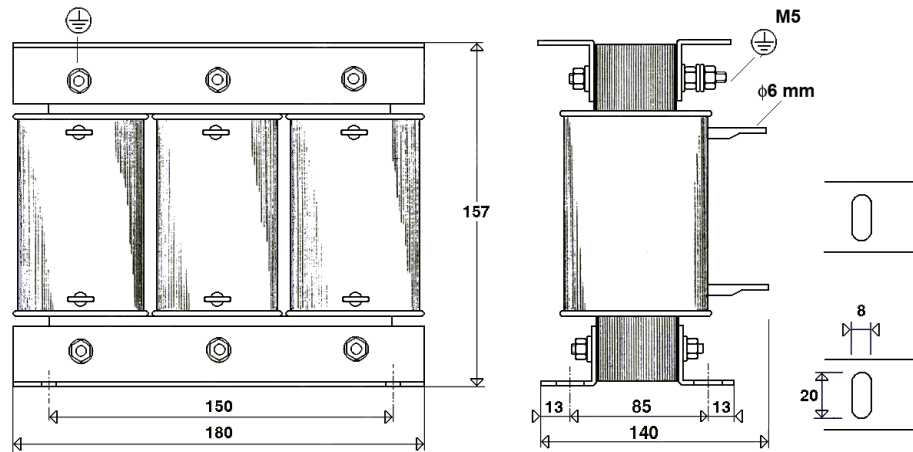

10.3 Connections to the motor

Under the designation "REK.." (resolver cables) and "MOK.."(motor cables) we can deliver motor connecting cables in various lengths to order. If you wish to make up your own cables, please consult the cable plans shown below:

Motor cable order code ⁽²⁾

for SMH / MH56 / MH70 / MH105 ⁽³⁾	(1.5mm ² ; up to 13.8A)	MOK	5 5	/ ⁽¹⁾
for SMH / MH56 / MH70 / MH105 ⁽³⁾	(1.5mm ² ; up to 13.8A) (cable chain compatible)	MOK	5 4	/ ⁽¹⁾
for SMH / MH56 / MH70 / MH105 ⁽³⁾	(2.5mm ² ; up to 18.9A)	MOK	5 6	/ ⁽¹⁾
for SMH / MH56 / MH70 / MH105 ⁽³⁾	(2.5mm ² ; up to 18.9A) (cable chain compatible)	MOK	5 7	/ ⁽¹⁾
for MH145 / MH205 ⁽⁴⁾	(1.5mm ² ; up to 13.8A)	MOK	6 0	/ ⁽¹⁾
for MH145 / MH205 ⁽⁴⁾	(1.5mm ² ; up to 13.8A) (cable chain compatible)	MOK	6 3	/ ⁽¹⁾
for MH145 / MH205 ⁽⁴⁾	(2.5mm ² ; up to 18.9A)	MOK	5 9	/ ⁽¹⁾
for MH145 / MH205 ⁽⁴⁾	(2.5mm ² ; up to 18.9A) (cable chain compatible)	MOK	6 4	/ ⁽¹⁾
for MH145 / MH205 ⁽⁴⁾	(6mm ² ; up to 32.3A) (cable chain compatible)	MOK	6 1	/ ⁽¹⁾
for MH145 / MH205 ⁽⁴⁾	(10mm ² ; up to 47.3A) (cable chain compatible)	MOK	6 2	/ ⁽¹⁾

^(x) **Note on cable** (see on page 308)

for resolver ⁽²⁾	for MH / SMH motors	REK	4 2	/ ⁽¹⁾
for resolver ⁽²⁾	for MH / SMH motors (cable chain compatible)	REK	4 1	/ ⁽¹⁾
for SinCos© – feedback ⁽²⁾	for MH / SMH motors (cable chain compatible)	GBK	2 4	/ ⁽¹⁾
for EnDat 2.1 ⁽²⁾	for MH / SMH motors (cable chain compatible)	GBK	3 8	/ ⁽¹⁾
for EnDat 2.2 ⁽²⁾	for MH / SMH motors (cable chain compatible)	GBK	5 6	/ ⁽¹⁾
Encoder – Compax3		GBK	2 3	/ ⁽¹⁾
for LXR linear motors	(cable chain compatible)	GBK	3 3	/ ⁽¹⁾
for BLMA linear motors	(cable chain compatible)	GBK	3 2	/ ⁽¹⁾

^(x) **Note on cable** (see on page 308)

In this chapter you can read about:

Resolver cable.....	321
SinCos© cable.....	322
EnDat cable.....	322
Motor cable.....	323
Encoder cable	324

10.3.1. Resolver cable

REK42/..

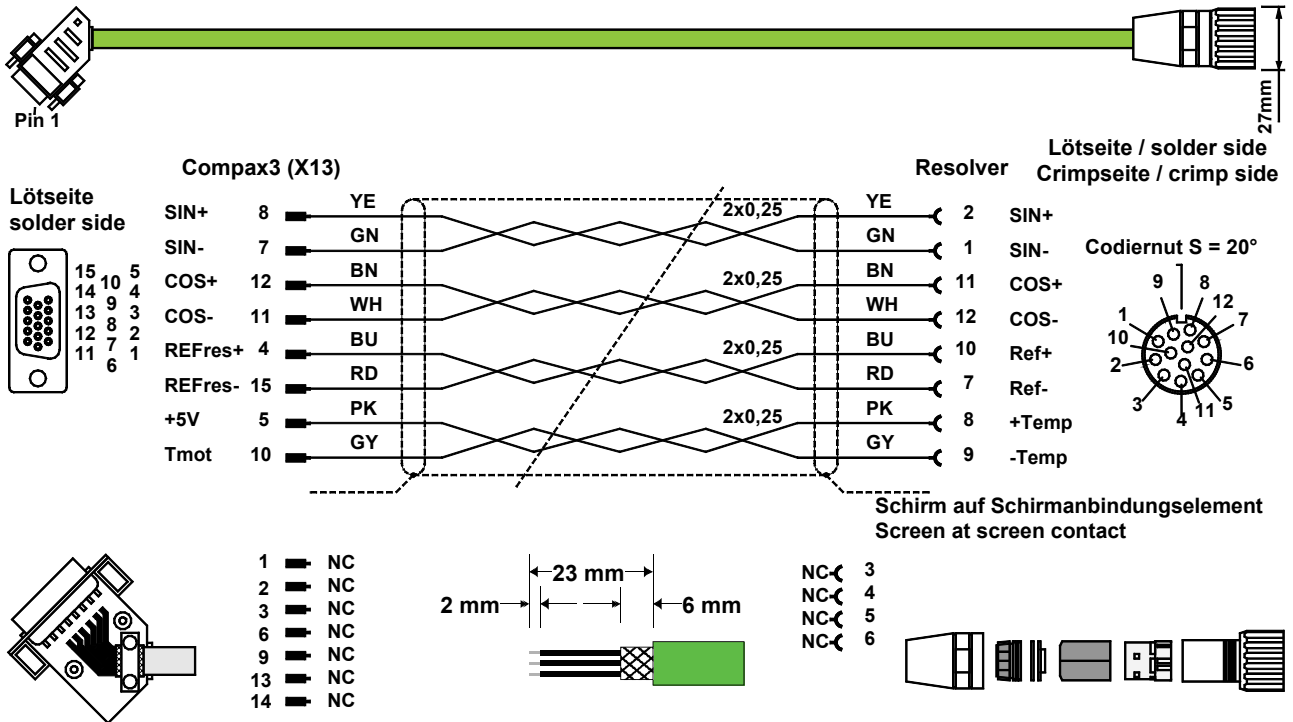

The same cable (with changed conductor coloring) is available under the designation REK41/.. in a version which is suitable for cable chain systems. You can find the length code in the Chapter **Order Code Accessories** (see on page 304).

10.3.2. SinCos© cable

GBK24/...: Cable chain compatible

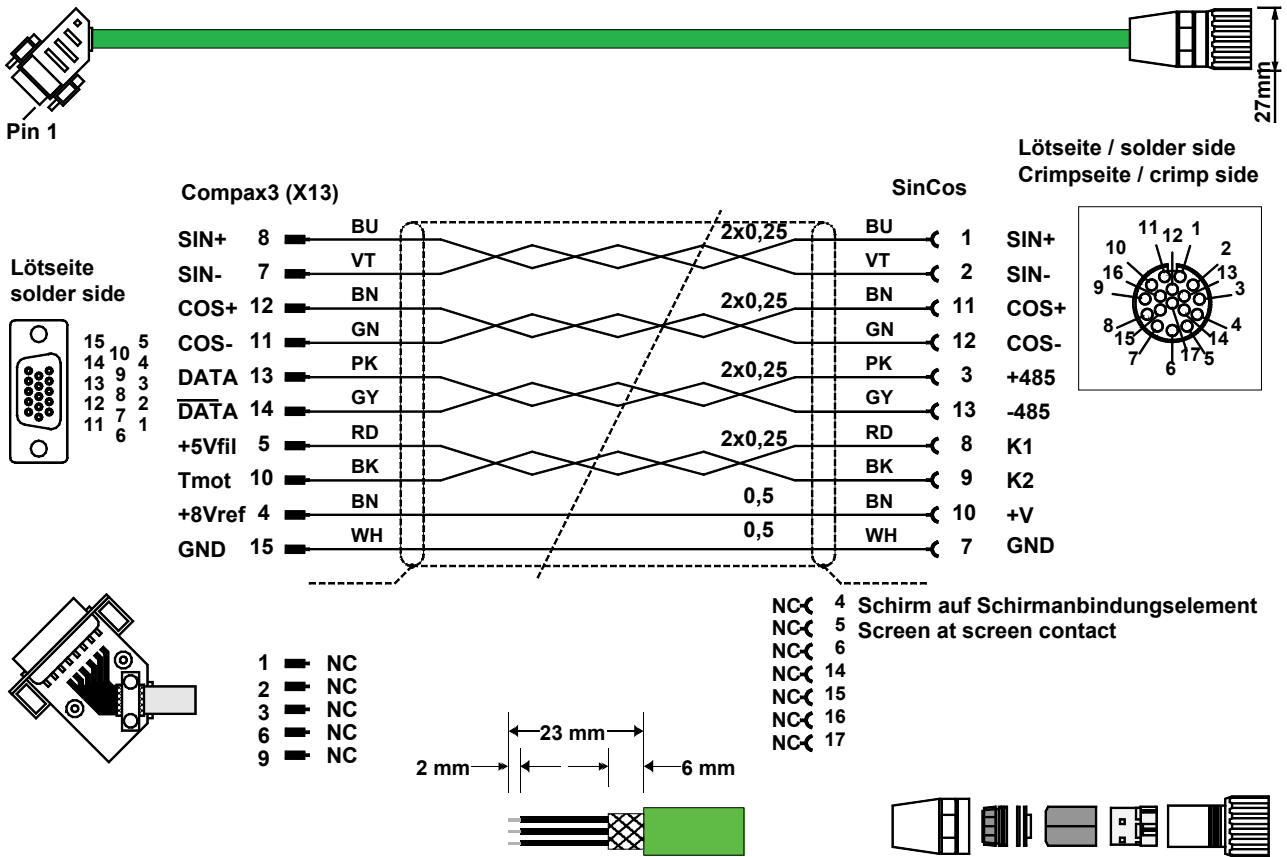

You can find the length code in the Chapter **Order Code Accessories** (see on page 304).

10.3.3. EnDat cable

GBK38/...: (cable chain compatible) for EnDat.1

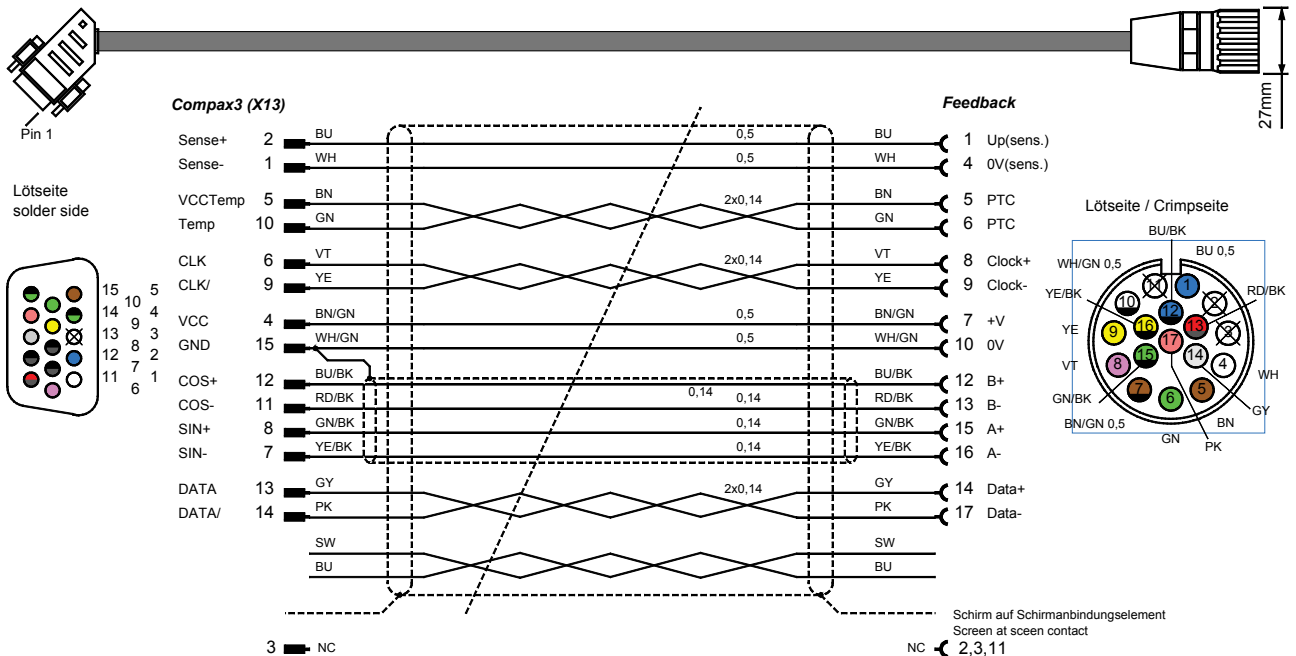

GBK56/...: (cable chain compatible) for EnDat2.2 (cable plan on request)
 You will find the length code in the **accessories order code** (see on page 304).

10.3.4. Motor cable

Cross-section / max. permanent load	Motor connector SMH motors MH56, MH70, MH105		Motor terminal box MH145, MH205	
	standard	cable chain compatible	standard	cable chain compatible
1.5 mm ² / up to 13.8 A	MOK55	MOK54	MOK60	MOK63
2.5 mm ² / up to 18.9 A	MOK56	MOK57	MOK59	MOK64
6 mm ² / up to 32.3 A	-	-	-	MOK61
10 mm ² / up to 47.3 A		--	-	MOK62

10.3.4.1 Connection of terminal box MH145 & MH205

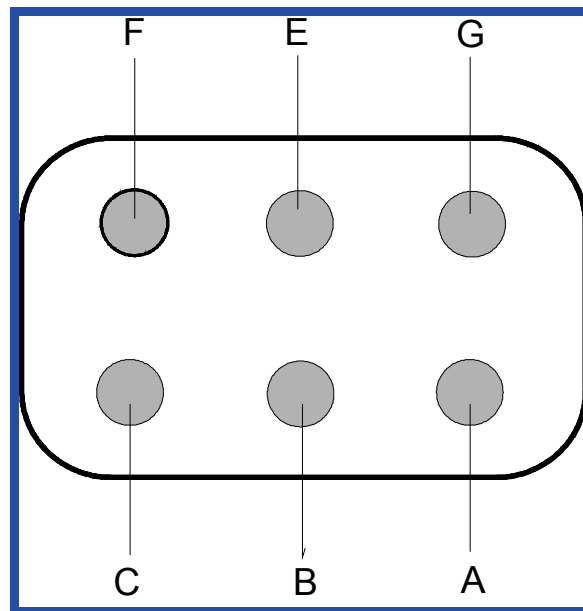

Terminal	Assignment
A	Phase U
B	Phase V
C	Phase W
E	Protective earth terminal
F	Brake (+ red for MH205)
G	Brake (- blue for MH205)

Additional designations can be found on the connection cable clamping board - motor (internal).

10.3.5. Encoder cable

GBK23/... Connection Compax3 - Encoder

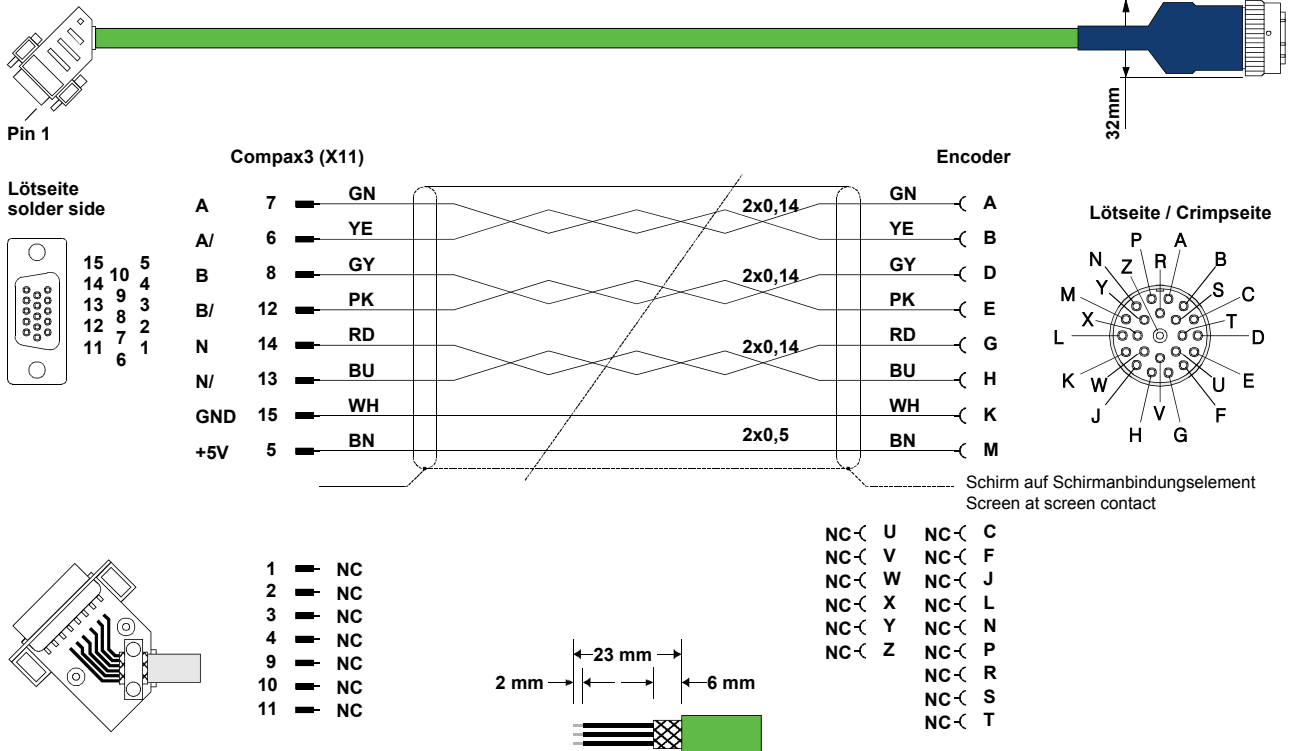

You can find the length code in the **Order Code Accessories** (see on page 304)

10.4 External braking resistors



Danger!

Hazards when handling ballast resistors!

Housing temperature up to 200°C!

Dangerous voltage!

The device may be operated only in the mounted state!

The external braking resistors must be installed such that protection against contact is ensured (IP20).

Install the connecting leads at the bottom.

The braking resistors must be grounded.

We recommend to use a thrust washer for the BRM13 and BRM14.

Observe the instructions on the resistors (warning plate).

Please note that the length of the supply cable must not exceed 2m!

In this chapter you can read about:

Permissible braking pulse powers of the braking resistors 326

Dimensions of the braking resistors 335

Ballast resistors Compax3

Ballast resistor (see on page 325)	Device	Nominal Power
BRM08/01 (100 Ω)	Compax3S025V2 Compax3S015V4 Compax3S038V4	60 W
BRM05/01 (56 Ω)	Compax3S063V2 Compax3S075V4	180 W
BRM05/02 (56 Ω)	Compax3S075V4	570 W
BRM10/01 (47 Ω)	Compax3S150V4	570 W
BRM10/02 (47 Ω)	Compax3S150V4	1500 kW
BRM04/01 (15 Ω)	Compax3S150V2 Compax3S300V4 PSUP20D6	570 W
BRM04/02 (15 Ω)	Compax3S150V2 Compax3S300V4 PSUP20D6	740 W
BRM04/03 (15 Ω)	Compax3S300V4 PSUP20D6	1500 W
BRM09/01 (22 Ω)	Compax3S100V2	570 W
BRM11/01 (27 Ω)	Compax3H0xxV4	3500 W
BRM13/01 (30 Ω)	PSUP10D6 PSUP20D6** PSUP30D6**	500 W
BRM14/01 (15 Ω)	PSUP10D6* PSUP20D6 PSUP30D6	500 W
BRM12/01 (18 Ω)	Compax3H1xxV4 PSUP30D6	4500 W

*for PSUP10D6 2x15Ω in series

**for PSUP20D6 and PSUP30D6 2x30Ω parallel

10.4.1. Permissible braking pulse powers of the braking resistors

In this chapter you can read about:

Calculation of the BRM cooling time	326
Permissible braking pulse power: BRM08/01 with C3S015V4 / C3S038V4	327
Permissible braking pulse power: BRM08/01 with C3S025V2	328
Permissible braking pulse power: BRM09/01 with C3S100V2	328
Permissible braking pulse power: BRM10/01 with C3S150V4	329
Permissible braking pulse power: BRM10/02 with C3S150V4	329
Permissible braking pulse power: BRM05/01 with C3S063V2	330
Permissible braking pulse power: BRM05/01 with C3S075V4	330
Permissible braking pulse power: BRM05/02 with C3S075V4	331
Permissible braking pulse power: BRM04/01 with C3S150V2	331
Permissible braking pulse power: BRM04/01 with C3S300V4	332
Permissible braking pulse power: BRM04/02 with C3S150V2	332
Permissible braking pulse power: BRM04/02 with C3S300V4	333
Permissible braking pulse power: BRM04/03 with C3S300V4	333
Permissible braking pulse power: BRM11/01 with C3H0xxV4	334
Permissible braking pulse power: BRM12/01 with C3H1xxV4	334
Permissible braking pulse power: BRM13/01 with PSUP10D6	335
Permissible braking pulse power: BRM14/01 with PSUP10D6	335

The diagrams show the permissible braking pulse powers of the braking resistors in operation with the assigned Compax3.

10.4.1.1 Calculation of the BRM cooling time

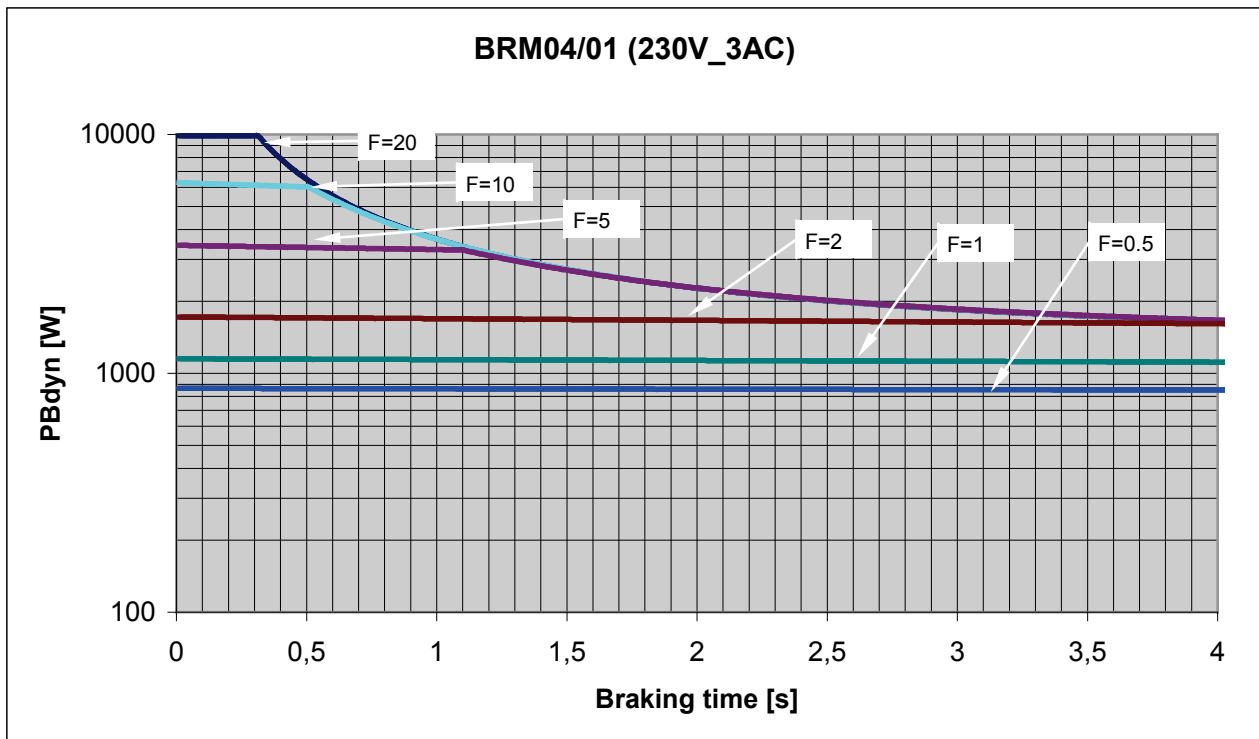

F = Factor

Cooling time = F * braking time

Example 1: For a braking time of 1s, a braking power of 1kW is required. The Diagram shows the following:

The required values can be found in the range between characteristic F = 0.5 and F = 1. In order to achieve operating safety, please select the higher factor, this means that the required cooling time is 1s.

$F * \text{Braking time} = \text{cooling time}$

$1 * 1s = 1s$

Example 2: For a braking time of 0.5s, a braking power of 3kW is required. The Diagram shows the following:

The required values can be found in the range between characteristic F = 2 and F = 5. In order to achieve operating safety, please select the higher factor, this means that the required cooling time is 2.5s.

$F * \text{Braking time} = \text{cooling time}$

$5 * 0.5s = 2.5s$

10.4.1.2 Permissible braking pulse power: BRM08/01 with C3S015V4 / C3S038V4

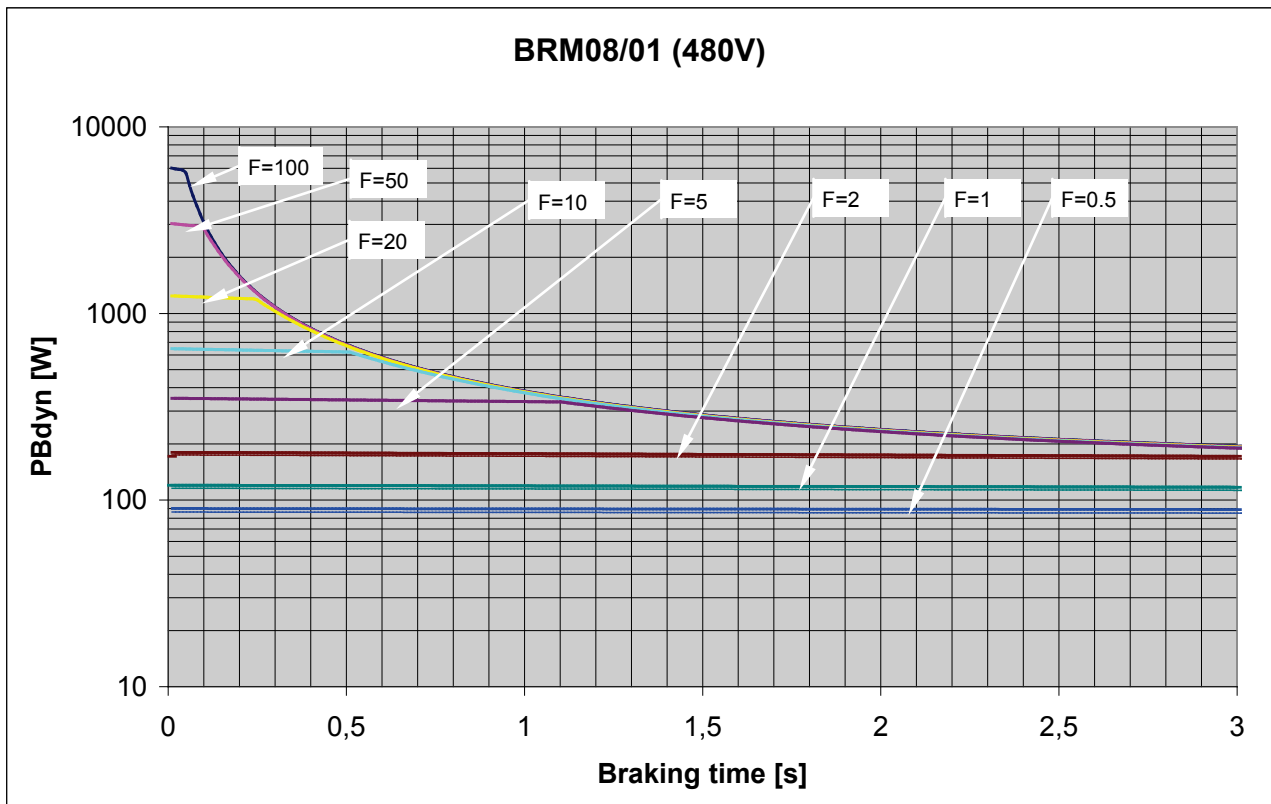

10.4.1.3 Permissible braking pulse power: BRM08/01 with C3S025V2

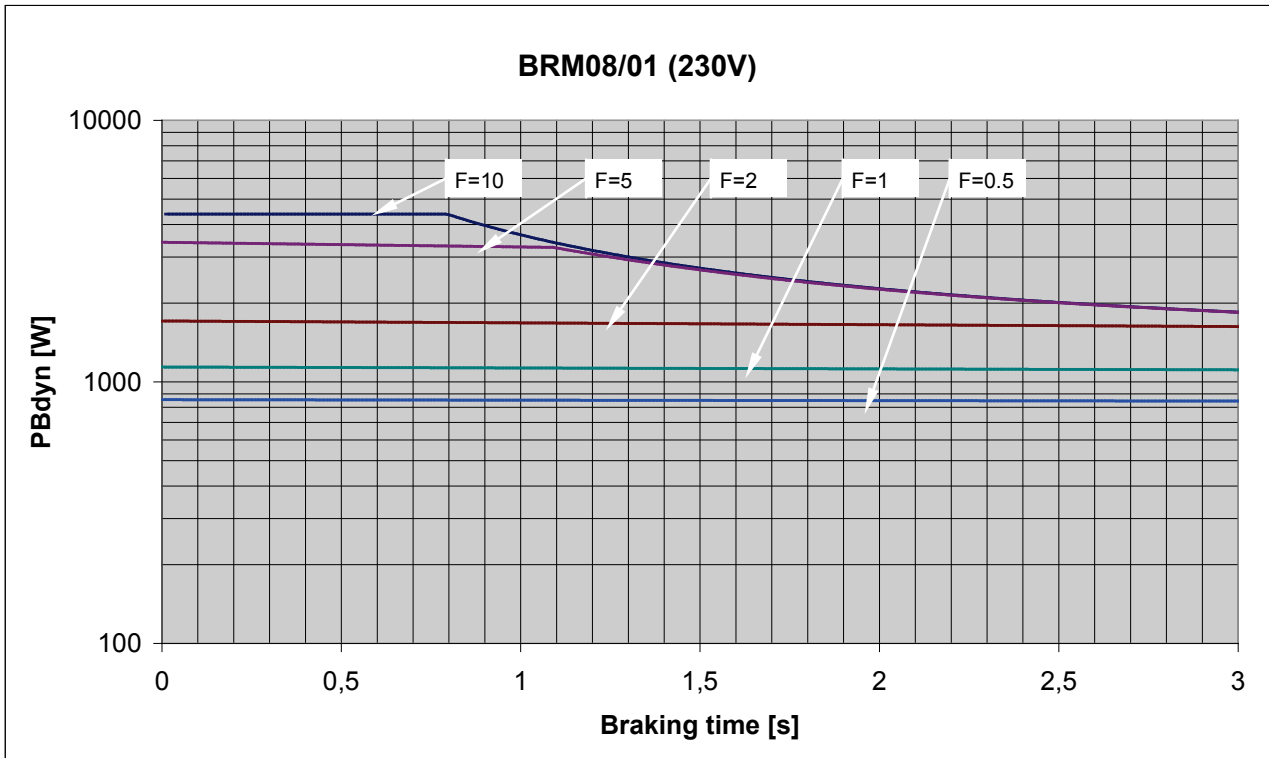

10.4.1.4 Permissible braking pulse power: BRM09/01 with C3S100V2

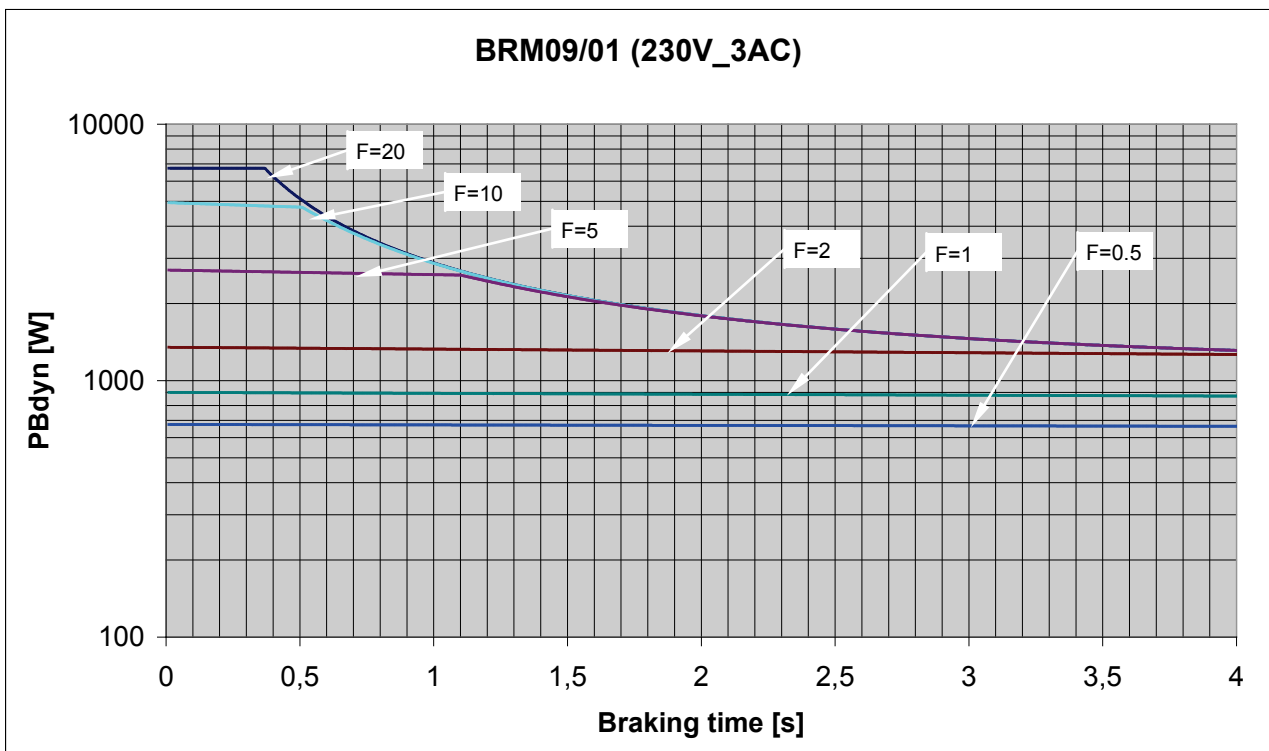

10.4.1.5 Permissible braking pulse power: BRM10/01 with C3S150V4

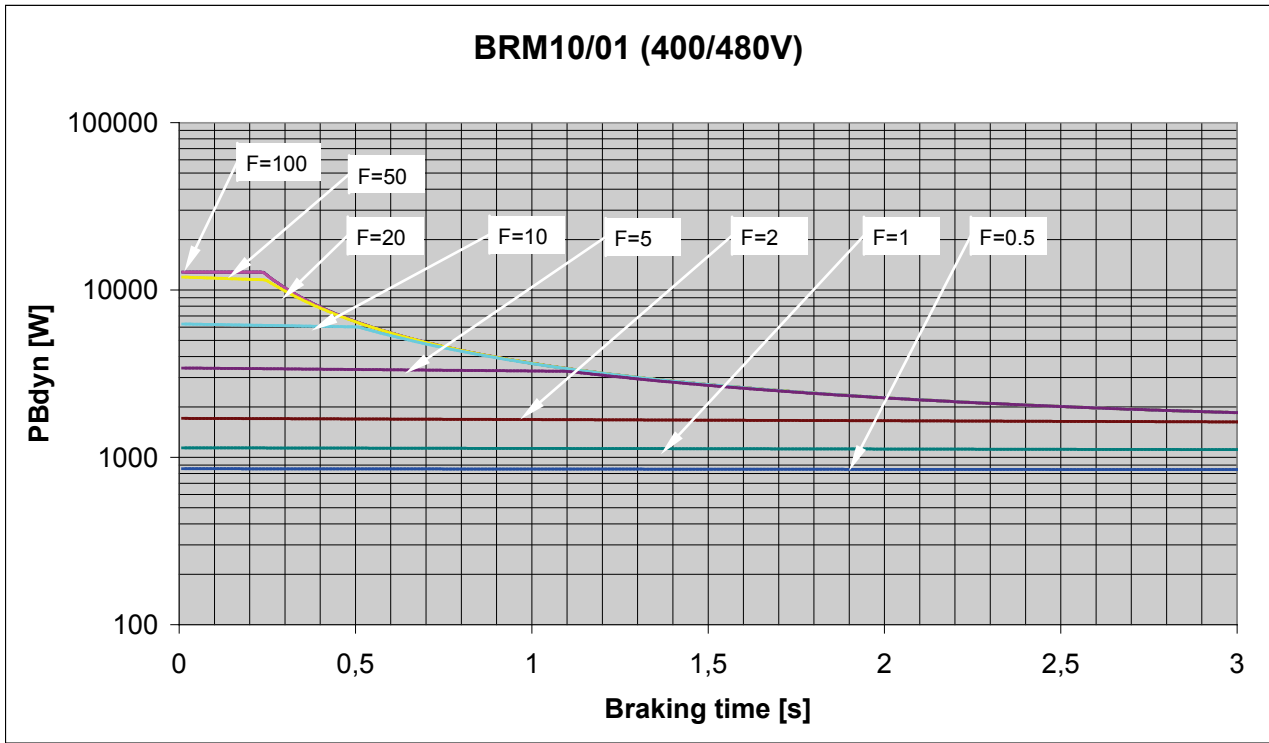

10.4.1.6 Permissible braking pulse power: BRM10/02 with C3S150V4

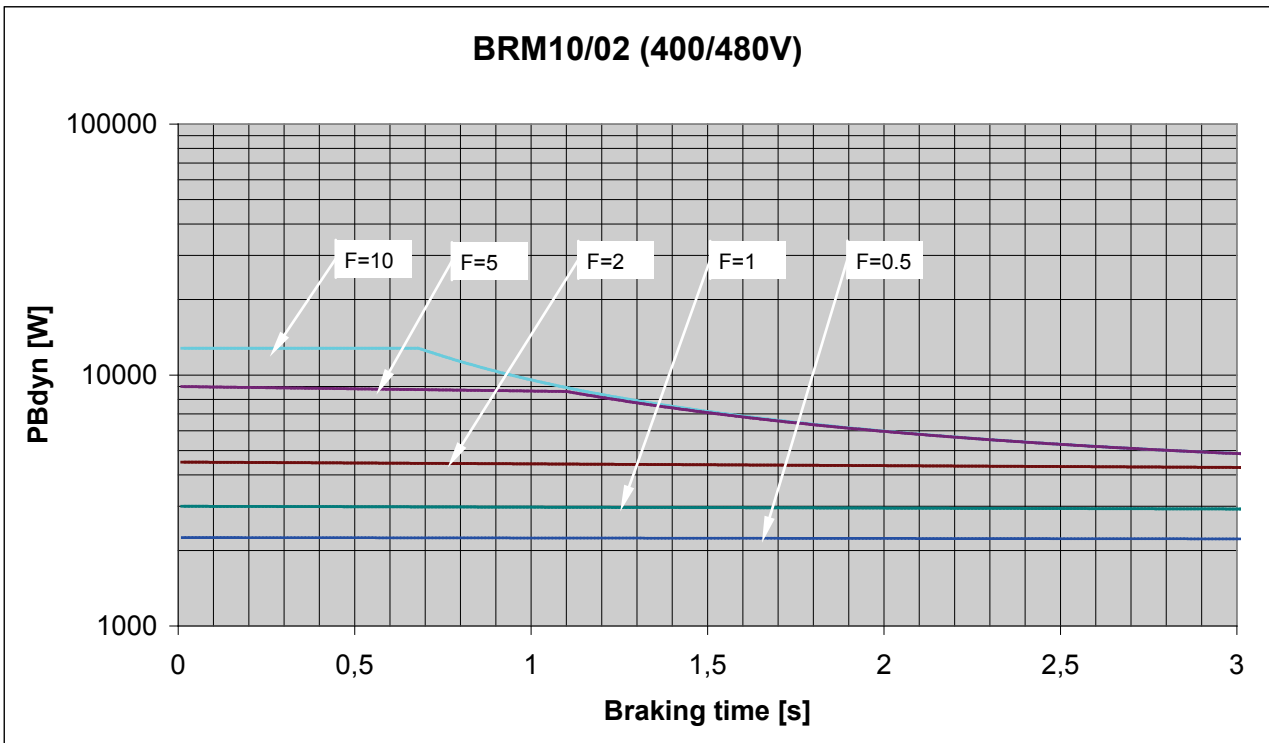

10.4.1.7 Permissible braking pulse power: BRM05/01 with C3S063V2

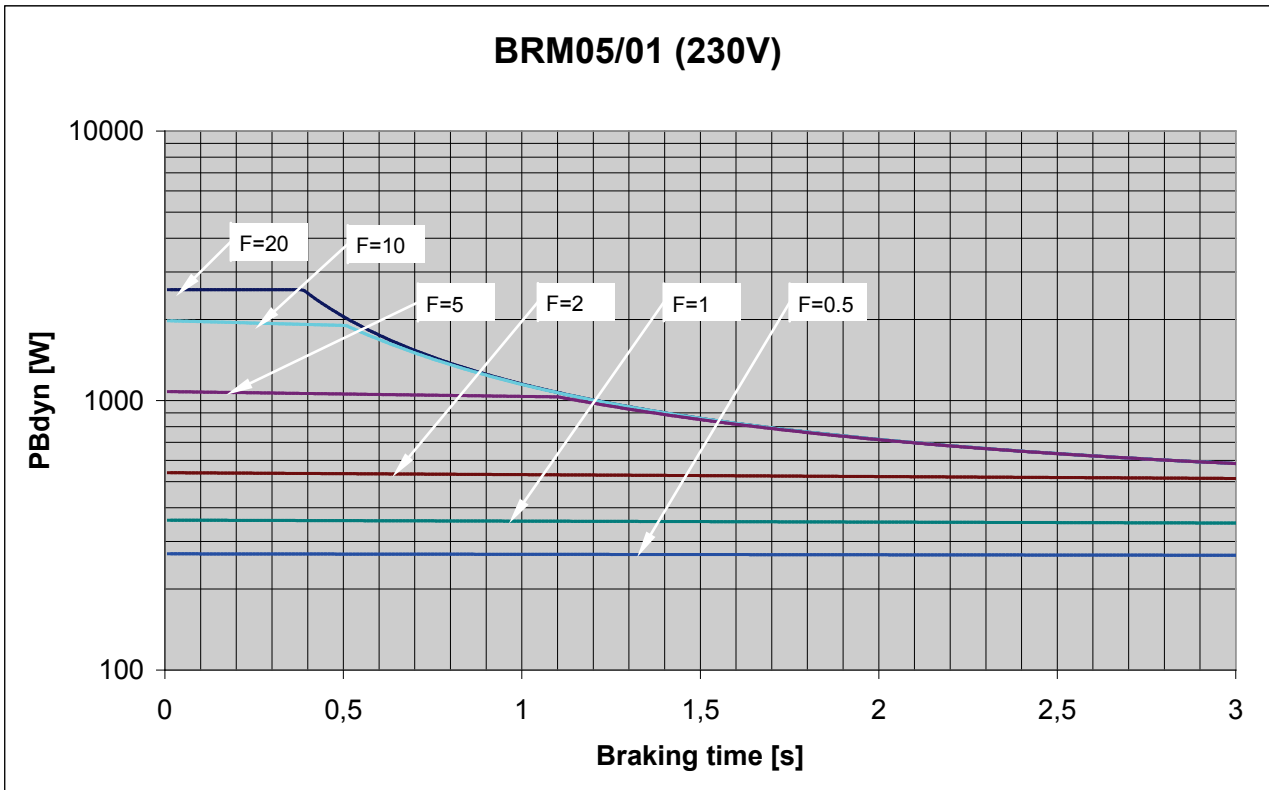

10.4.1.8 Permissible braking pulse power: BRM05/01 with C3S075V4

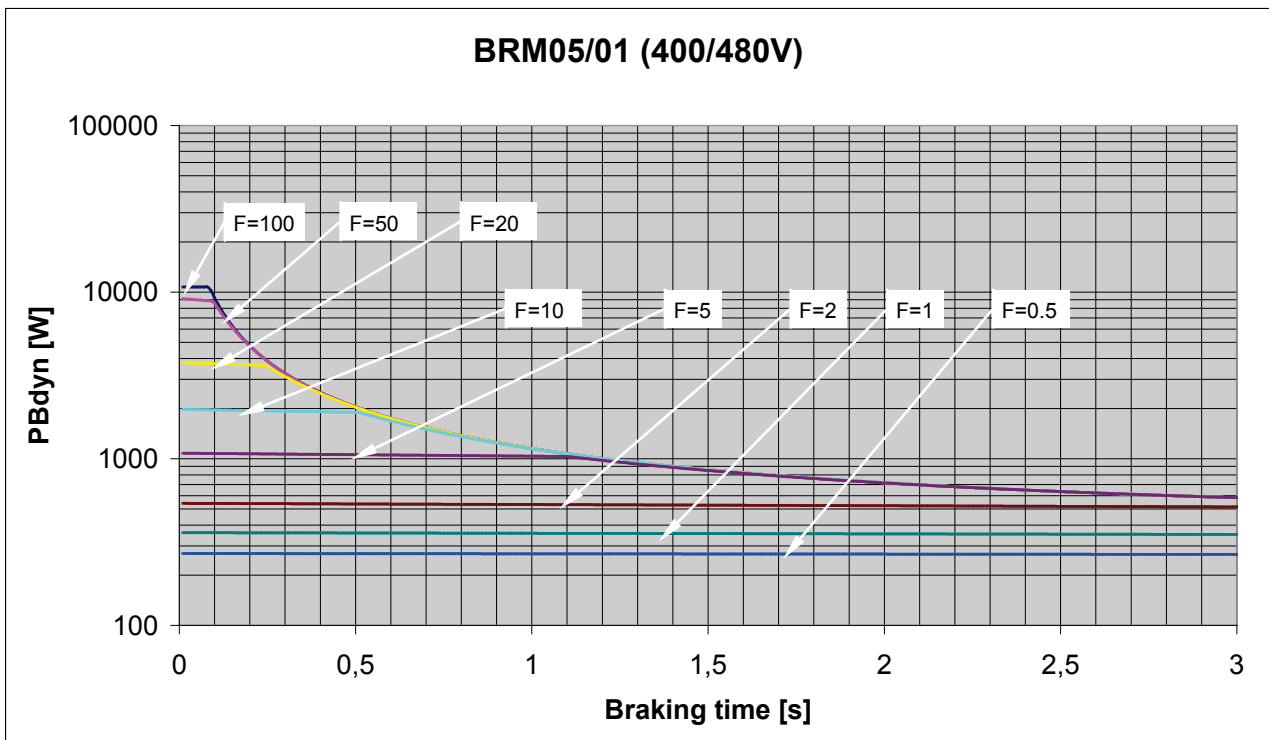

10.4.1.9 Permissible braking pulse power: BRM05/02 with C3S075V4

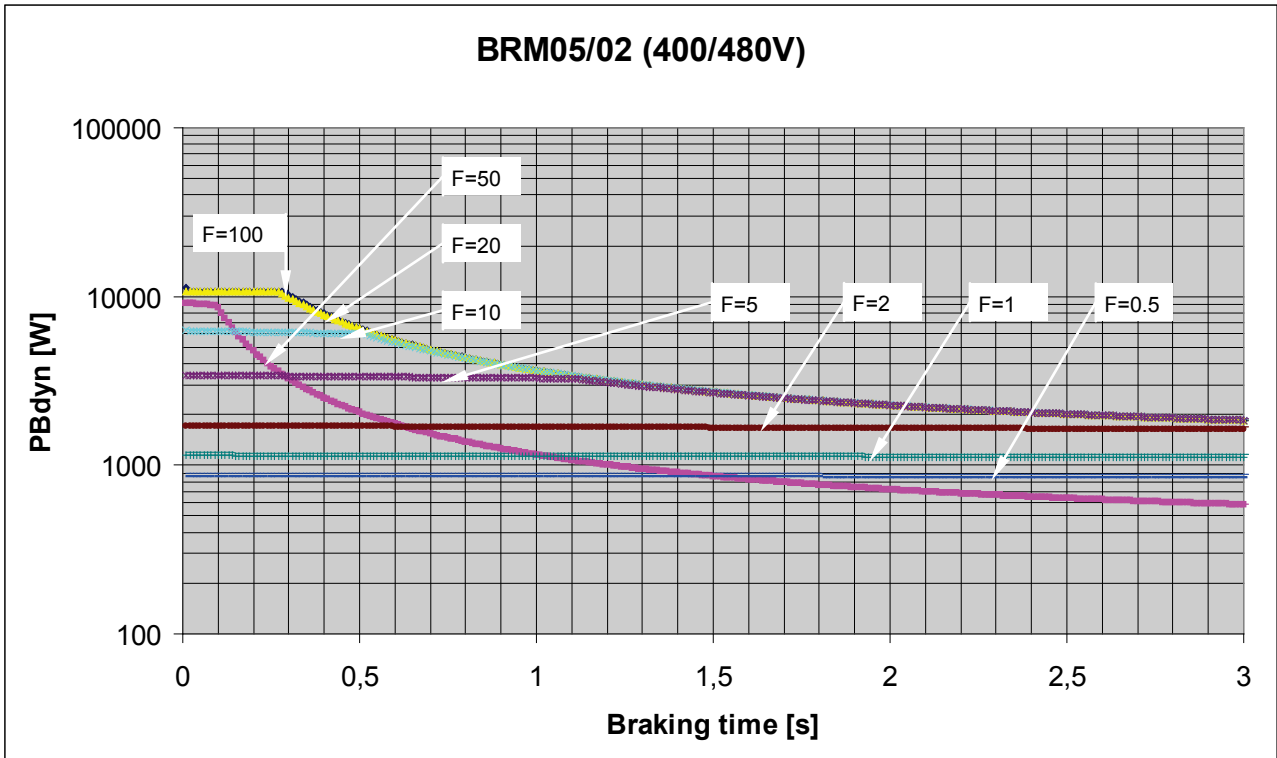

10.4.1.10 Permissible braking pulse power: BRM04/01 with C3S150V2

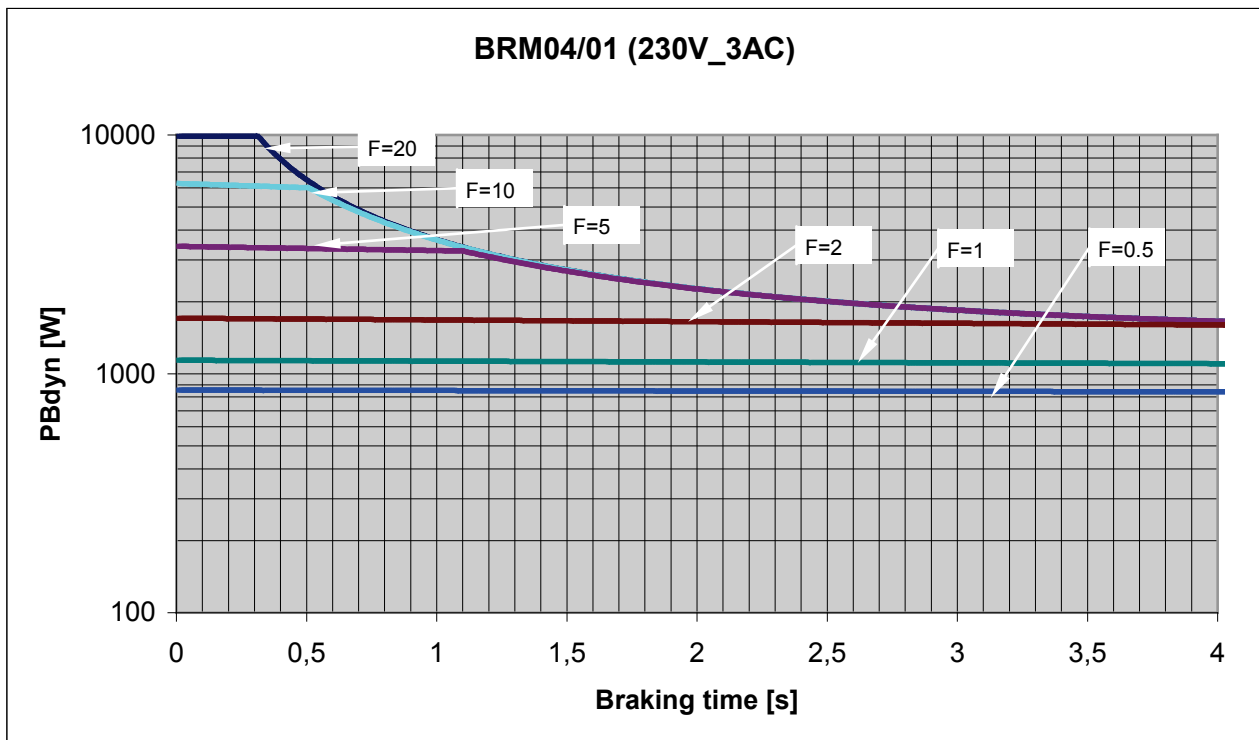

10.4.1.11 Permissible braking pulse power: BRM04/01 with C3S300V4

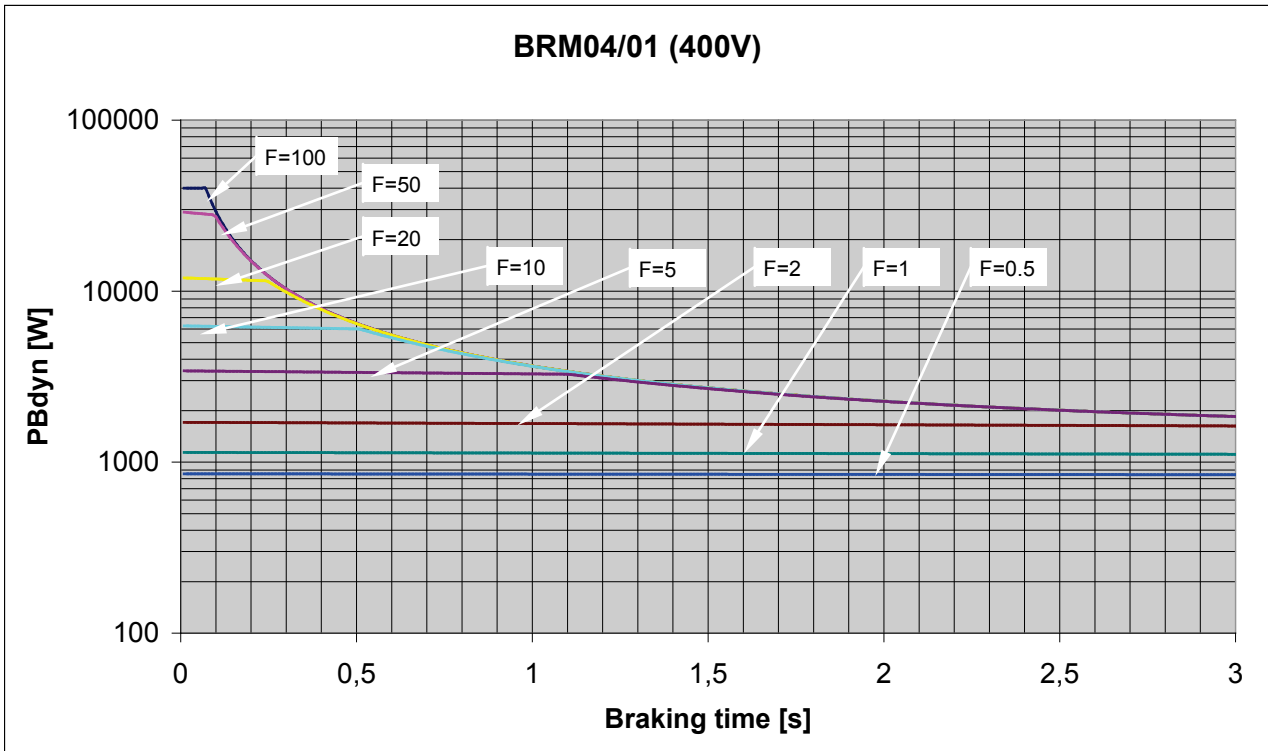

10.4.1.12 Permissible braking pulse power: BRM04/02 with C3S150V2

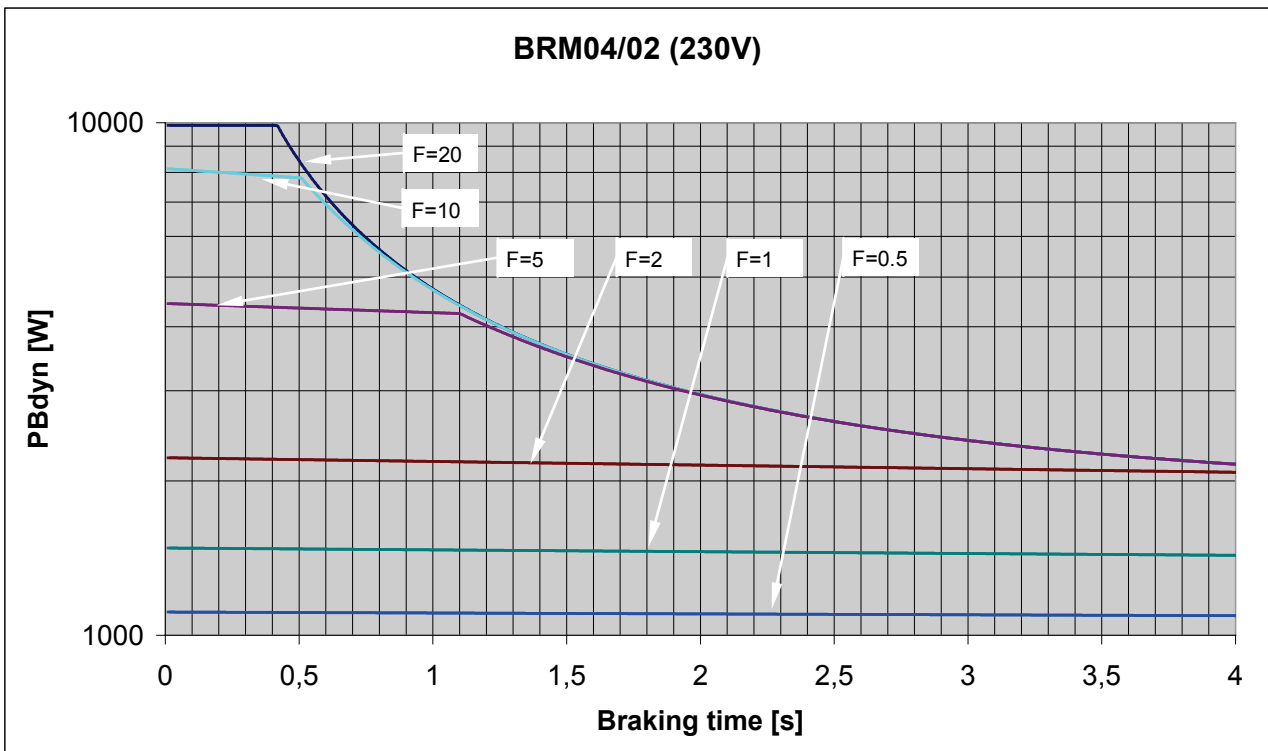

10.4.1.13 Permissible braking pulse power: BRM04/02 with C3S300V4

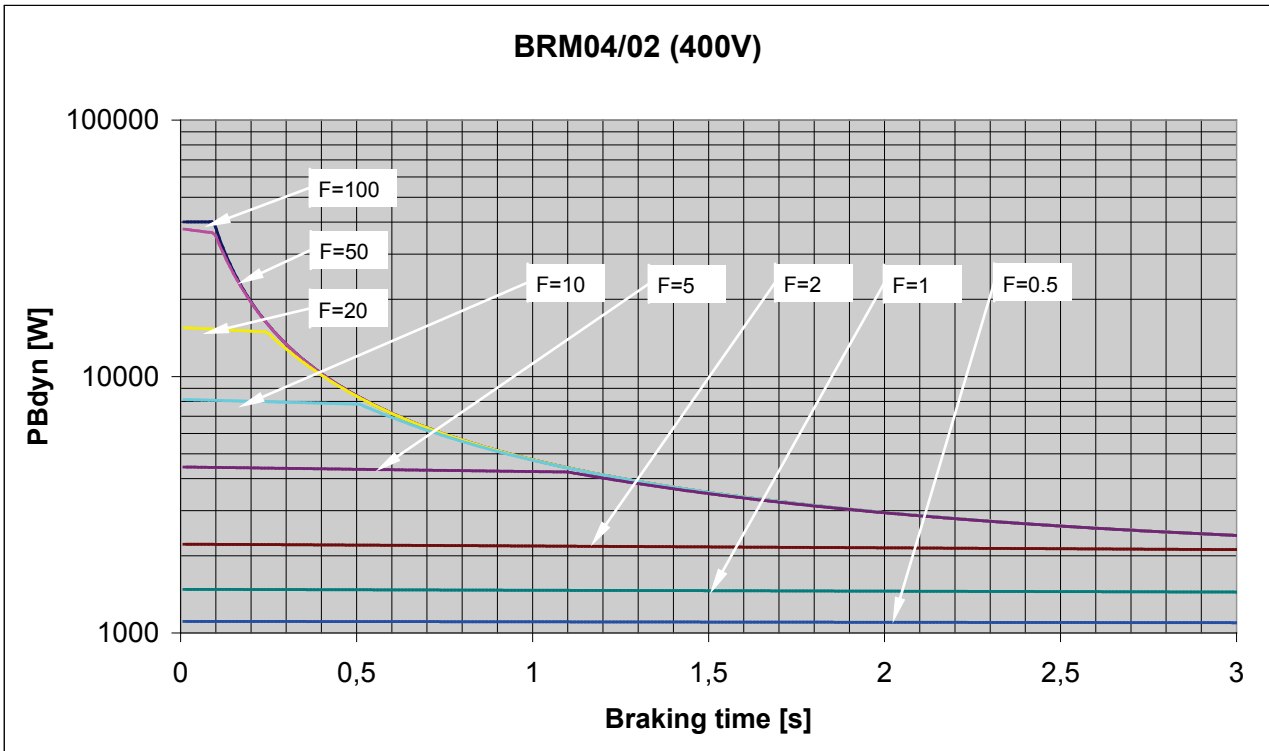

10.4.1.14 Permissible braking pulse power: BRM04/03 with C3S300V4

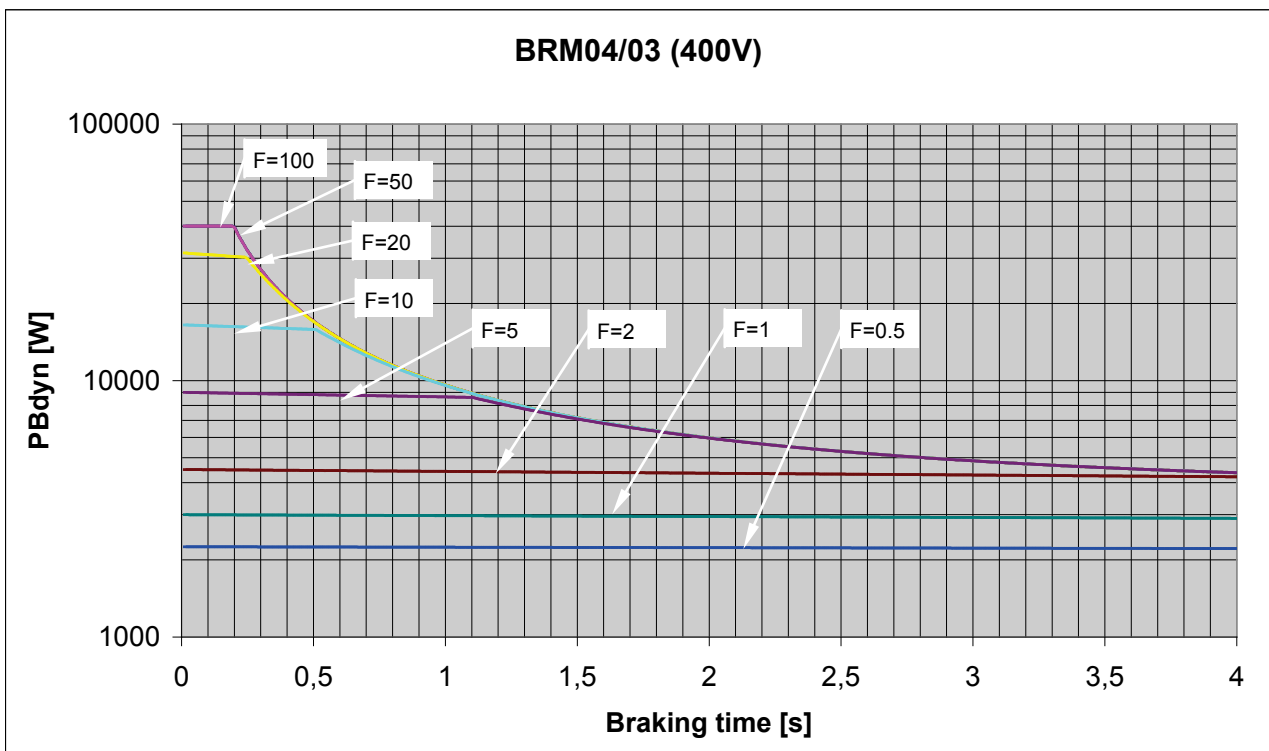

10.4.1.15 Permissible braking pulse power: BRM11/01 with C3H0xxV4

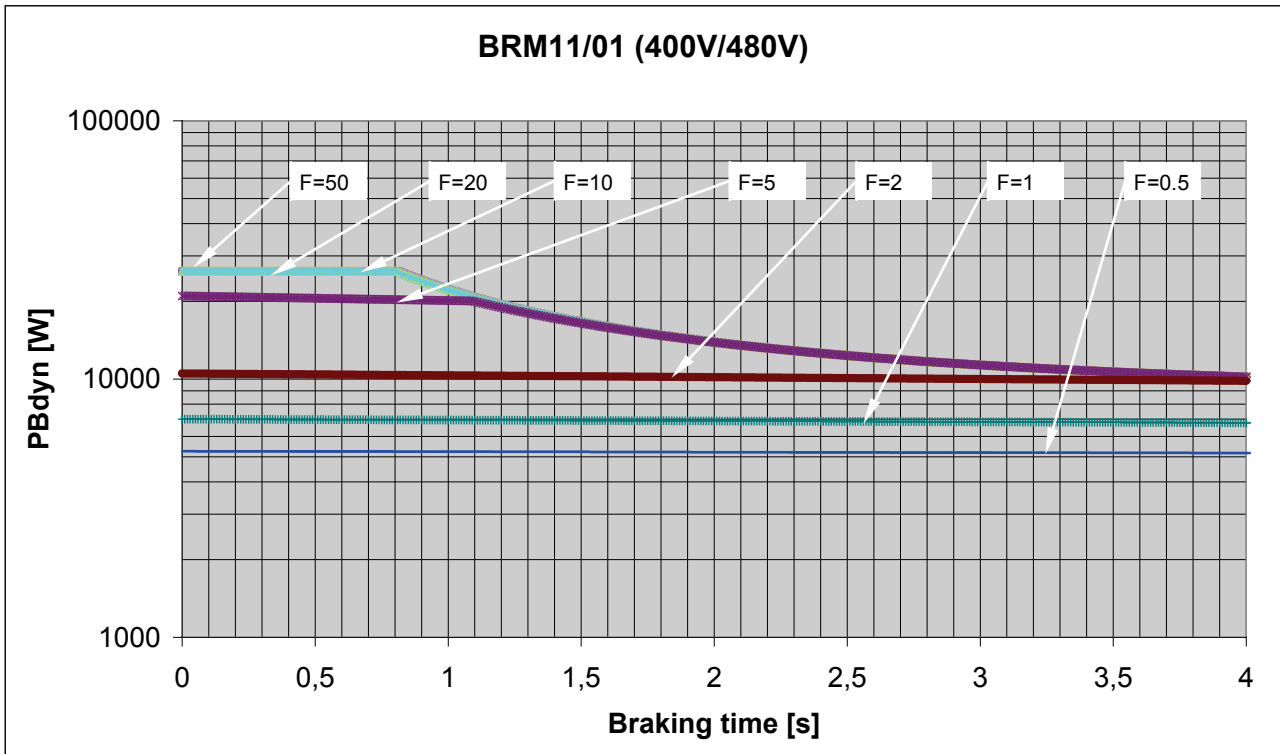

10.4.1.16 Permissible braking pulse power: BRM12/01 with C3H1xxV4

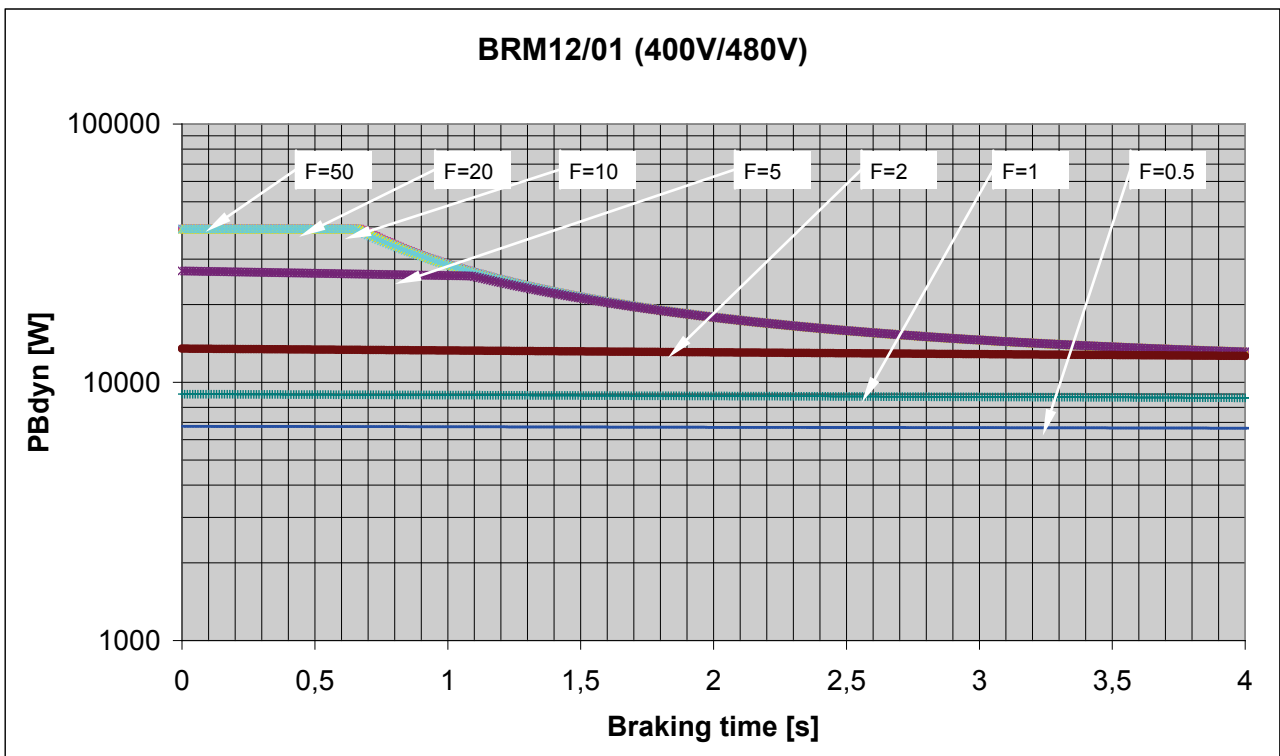

10.4.1.17 **Permissible braking pulse power: BRM13/01 with PSUP10D6**

on request

10.4.1.18 **Permissible braking pulse power: BRM14/01 with PSUP10D6**

on request

10.4.2. Dimensions of the braking resistors

In this chapter you can read about:

BRM8/01braking resistors.....	335
BRM5/01 braking resistor	335
Braking resistor BRM5/02, BRM9/01 & BRM10/01	336
Braking resistor BRM4/0x and BRM10/02	336
Braking resistor BRM11/01 & BRM12/01	337
Ballast resistor BRM13/01 & BRM14/01	337

10.4.2.1 **BRM8/01braking resistors**

Dimensional drawing:

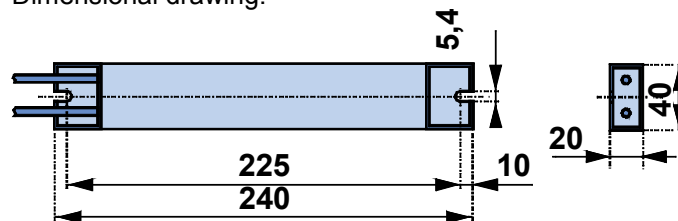

Stated in mm

10.4.2.2 **BRM5/01 braking resistor**

Dimensional drawing:

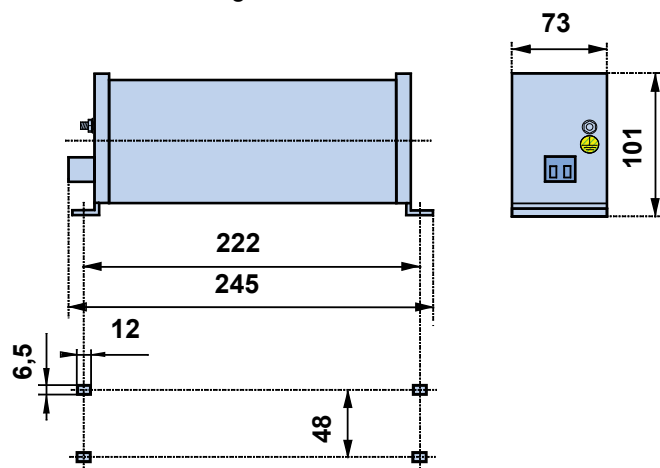

Stated in mm

10.4.2.3 Braking resistor BRM5/02, BRM9/01 & BRM10/01

Dimensional drawing:

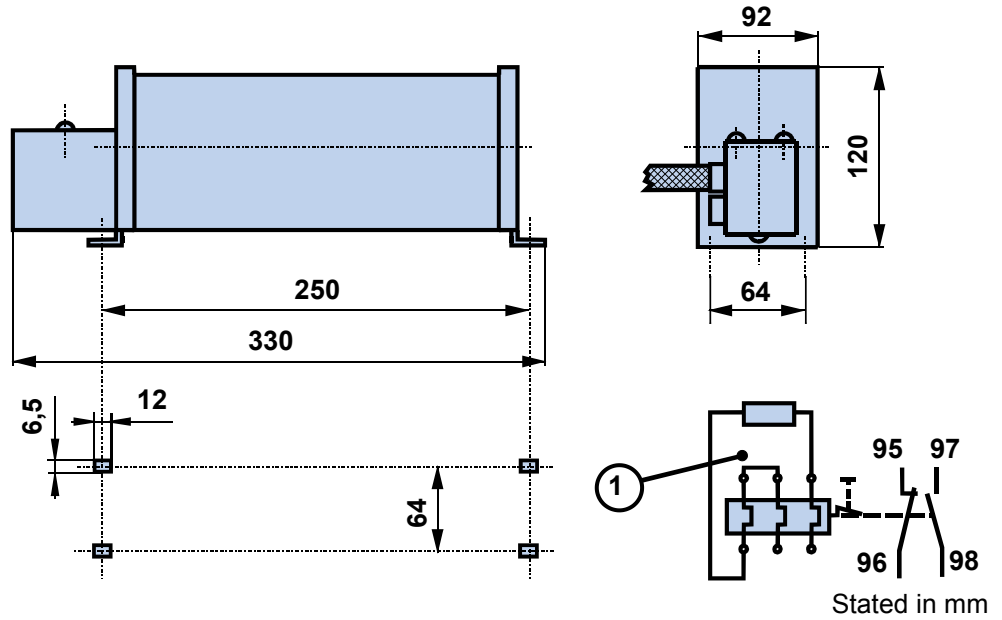

10.4.2.4 Braking resistor BRM4/0x and BRM10/02

Dimensional drawing:

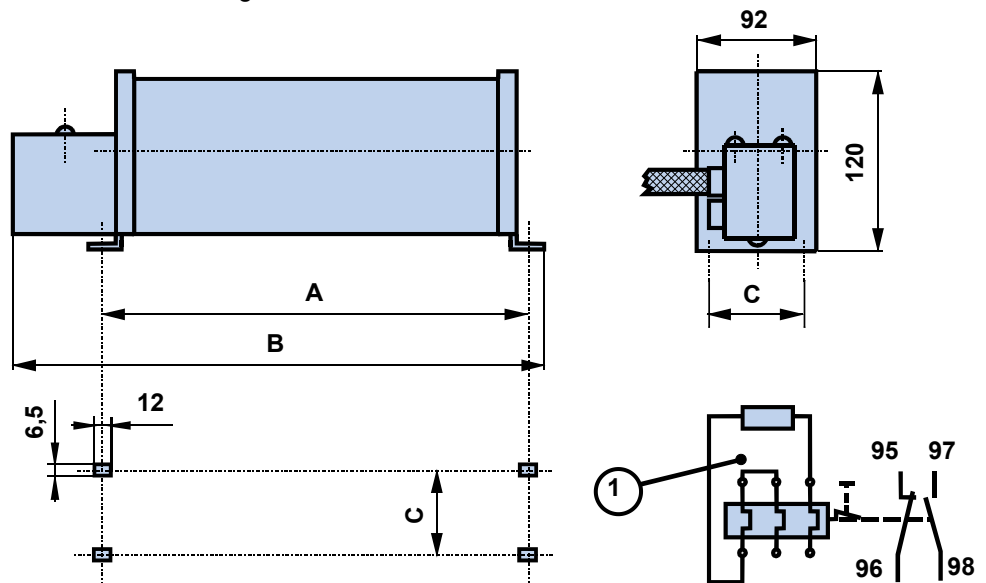

1: thermal overcurrent relay

		BRM4/01	BRM4/02	BRM4/03 & BRM10/02
A	mm	250	300	540
B	mm	330	380	620
C	mm	64	64	64

10.4.2.5 Braking resistor BRM11/01 & BRM12/01

Dimensional drawing:

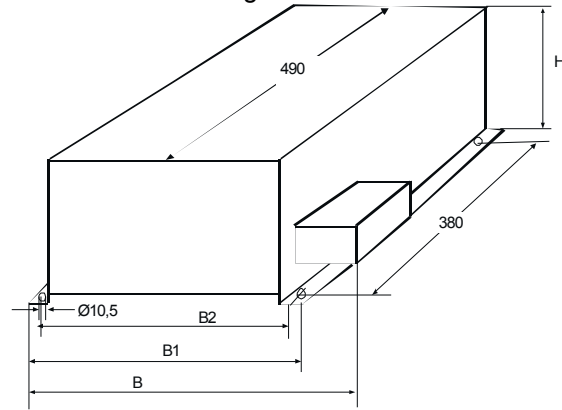

		BRM11/01	BRM12/02
W	mm	330	
W1	mm	295	
W2	mm	270	
H	mm	260	
Weight	kg	6.0	7.0

10.4.2.6 Ballast resistor BRM13/01 & BRM14/01

Dimensional drawing:

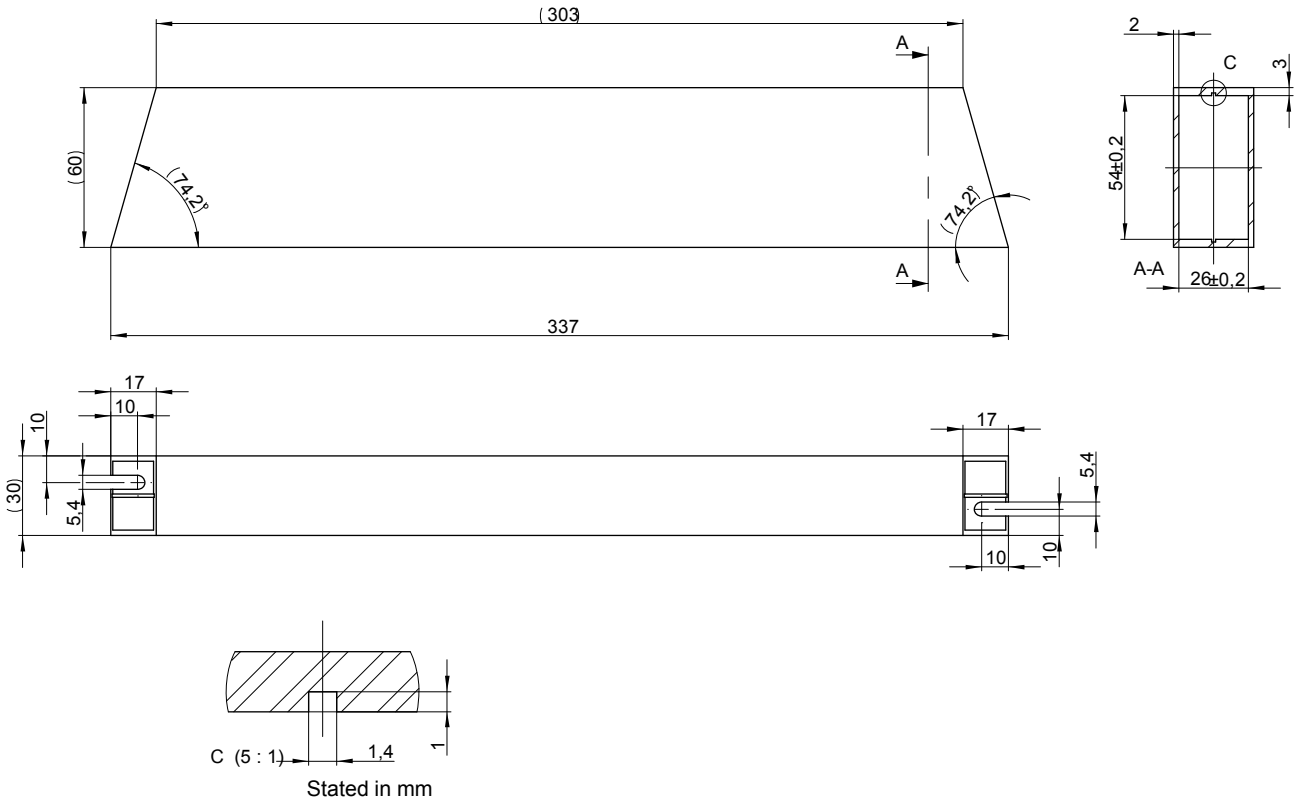

10.5 Capacitor module C4

Order code capacitor module

for C3S300V4	1100µF	Module	C4
--------------	--------	--------	----

Technical Data

Type	Capacity	Cable length
Module C4	1100µF	~30 cm

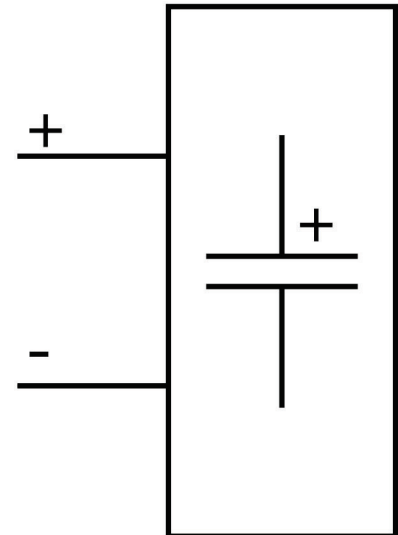

Module C4	A	B	C	C1	D	I	F	G	H
	mm								
	430	190	90	120	370	15	18	30	∅6

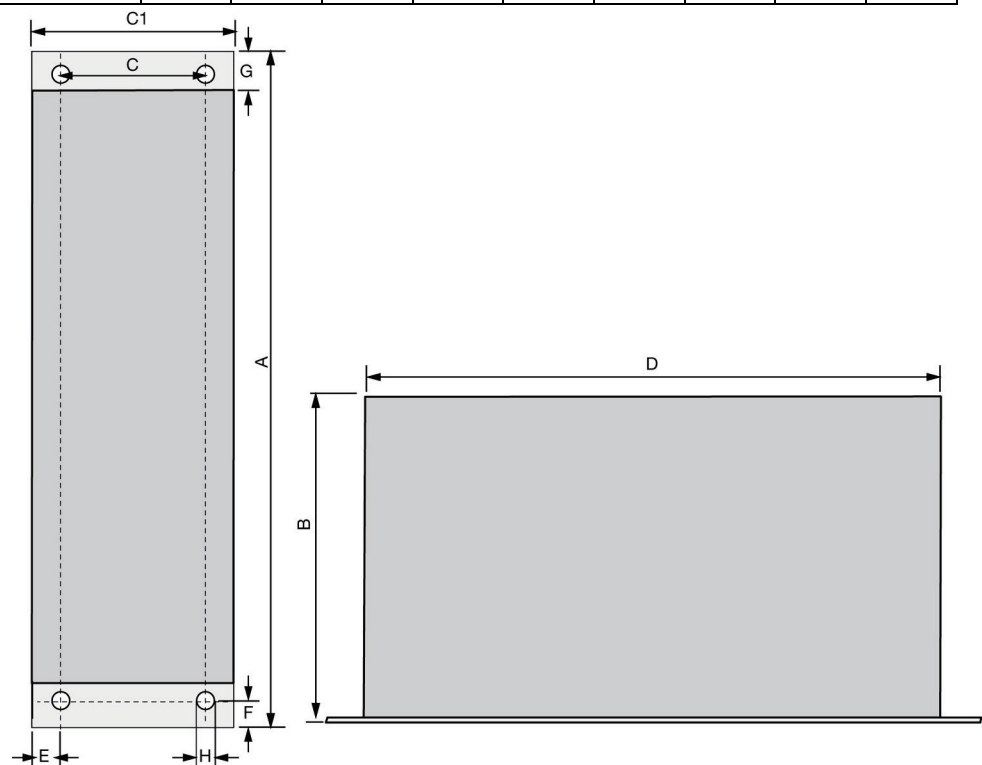

10.6 Operator control module BDM

Order Code operating module

Operating module (for Compax3S and Compax3F)

BDM		0	1	/	0	1	

Flexible service and maintenance



Functions:

- ◆ Mobile or stationary handling: can remain on the unit for display and diagnostic purposes, or can be plugged into any unit.
- ◆ Can be plugged in while in operation
- ◆ Power supply via Compax3 servo control
- ◆ Display with 2 times 16 places.
- ◆ Menu-driven operation using 4 keys.
- ◆ Displays and changing of values.
- ◆ Display of Compax3 messages.
- ◆ Duplication of device properties and IEC61131-3 program to another Compax3 with identical hardware.
- ◆ Additional information can be found in the BDM manual This can be found on the Compax3 CD or on our Homepage: **BDM-manual** (http://divapps.parker.com/divapps/EME/EME/Literature_List/dokumentation/BDM.pdf).

10.7 EAM06: terminal block for inputs and outputs

Order Code terminal block

for I/Os without luminous indicator
for I/Os with luminous indicator

for X11, X12, X22
for X12, X22

EAM		0	6	/	0	1	
EAM		0	6	/	0	2	

The terminal block EAM06/.. can be used to route the Compax3 plug connector X11 or X12 for further wiring to a terminal strip and to a Sub-D plug connector.

Via a supporting rail (Design: or) the terminal unit can be attached to a mounting rail in the switch cabinet.

EAM06/ is available in 2 variants:

- ◆ EAM06/01: Terminal block for X11, X12, X22 without luminous indicator
 - ◆ EAM06/02: Terminal block for X12, X22 with luminous indicator
- Corresponding connecting cables EAM06 - Compax3 are available:
- ◆ from X11 - EAM06/01: SSK23/..
 - ◆ from X12, X22 - EAM06/xx: SSK24/..

EAM6/01: Terminal block without luminous indicator for X11, X12 or X22

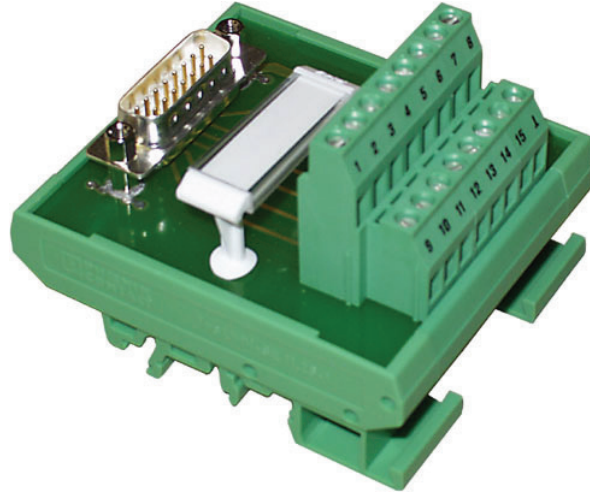

Width: 67.5mm

Figure similar

EAM6/02: Terminal block with luminous indicator for X12, X22

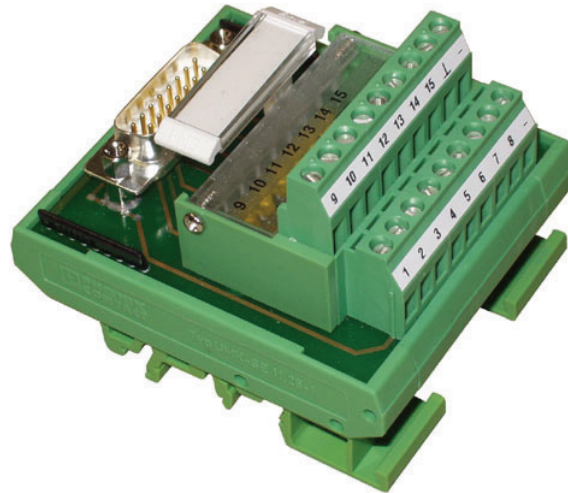

Width: 67.5mm

Figure similar

Cable plan SSK23/...: X11 to EAM 06/01

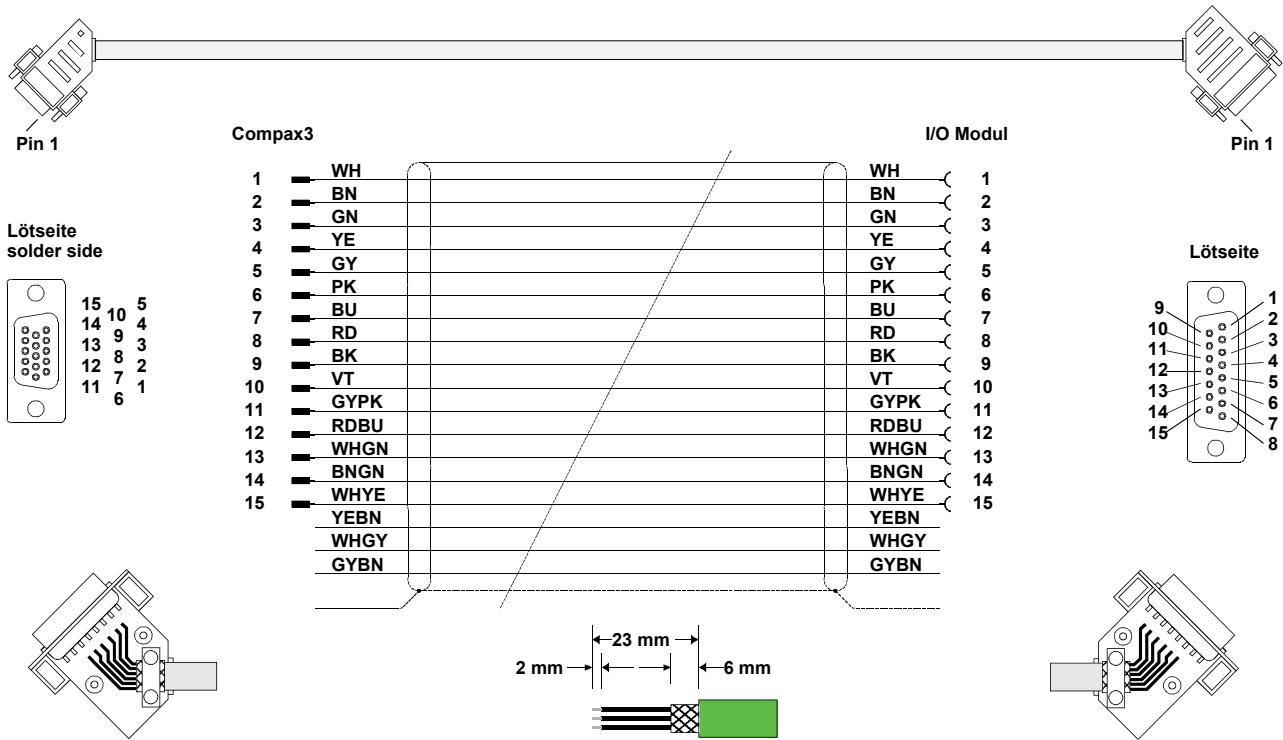

Cable plan SSK24/...: X12 to EAM 06/xx

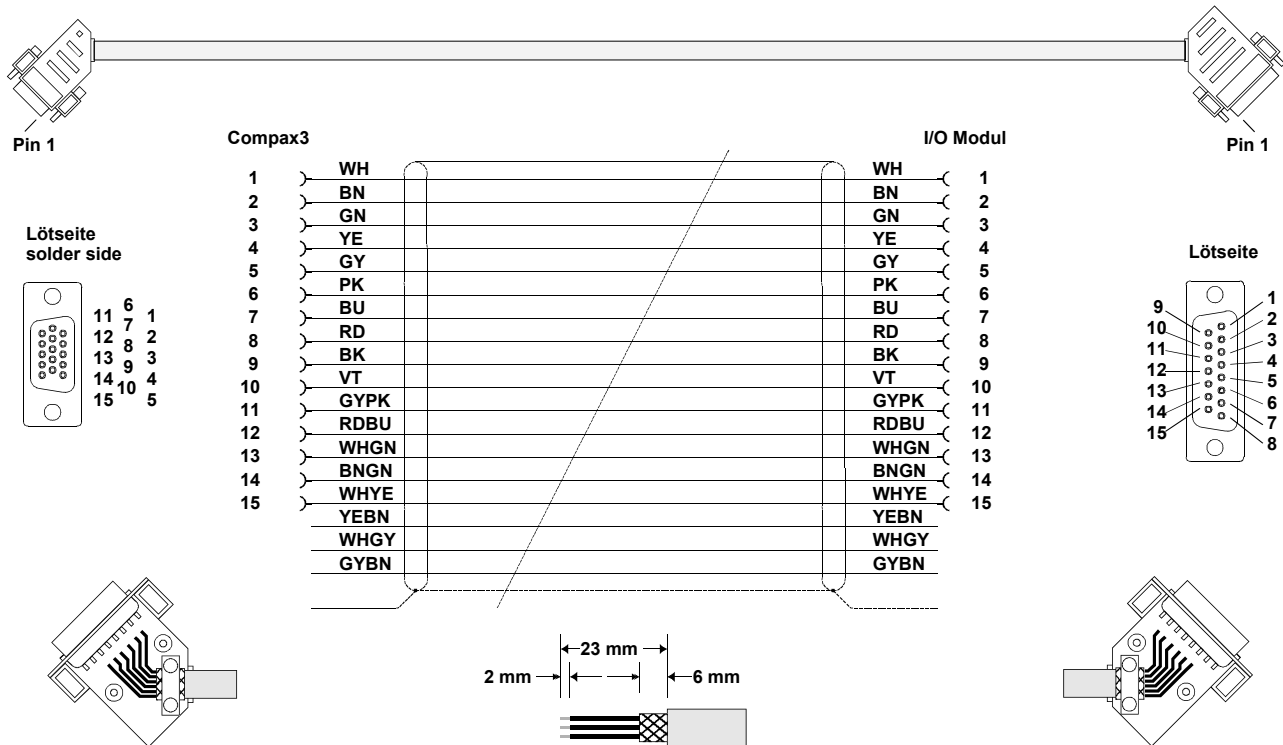

10.8.2. RS485 cable to Pop / SSK27

SSK27: Connection Pop - Compax3 - Compax3 - ...

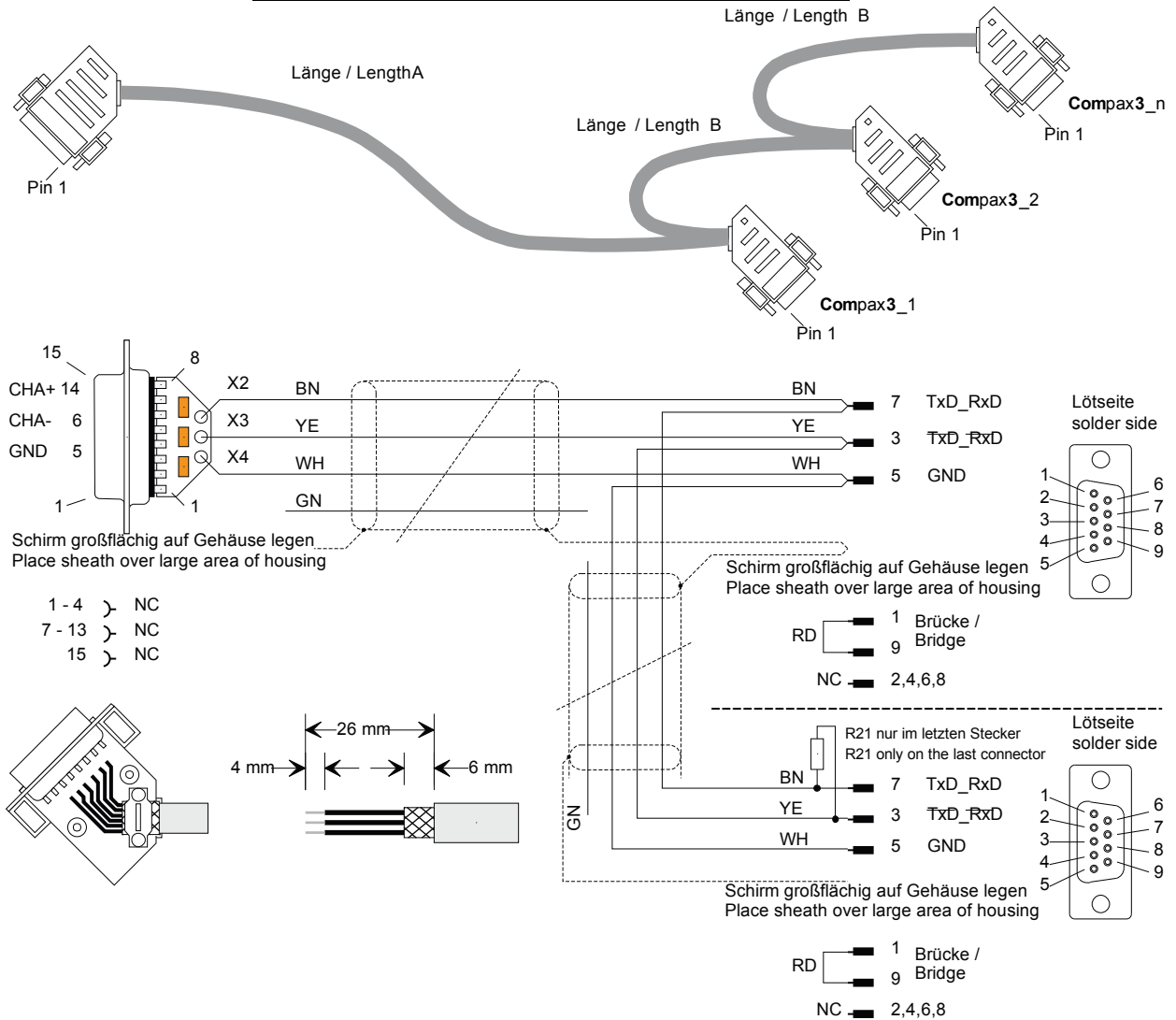

R21 = 220 Ohm

⁽⁶⁾ **Order code: SSK27/nn/..**

Length A (Pop - 1. Compax3) variable (the last two numbers according to the length code for cable, for example SSK27/nn/01)

Length B (1. Compax3 - 2. Compax3 - ... - n. Compax3) fixed 50 cm (only if there is more than 1 Compax3, i.e. nn greater than 01)

Number n (the last two digits)

Examples include:

SSK27/05/.. for connecting from Pop to 5 Compax3.

SSK27/01/.. for connecting from Pop to one Compax3

10.8.3. I/O-interface X12 / X22 / SSK22

SSK22/...: Cable for X12 / X22 with flying leads

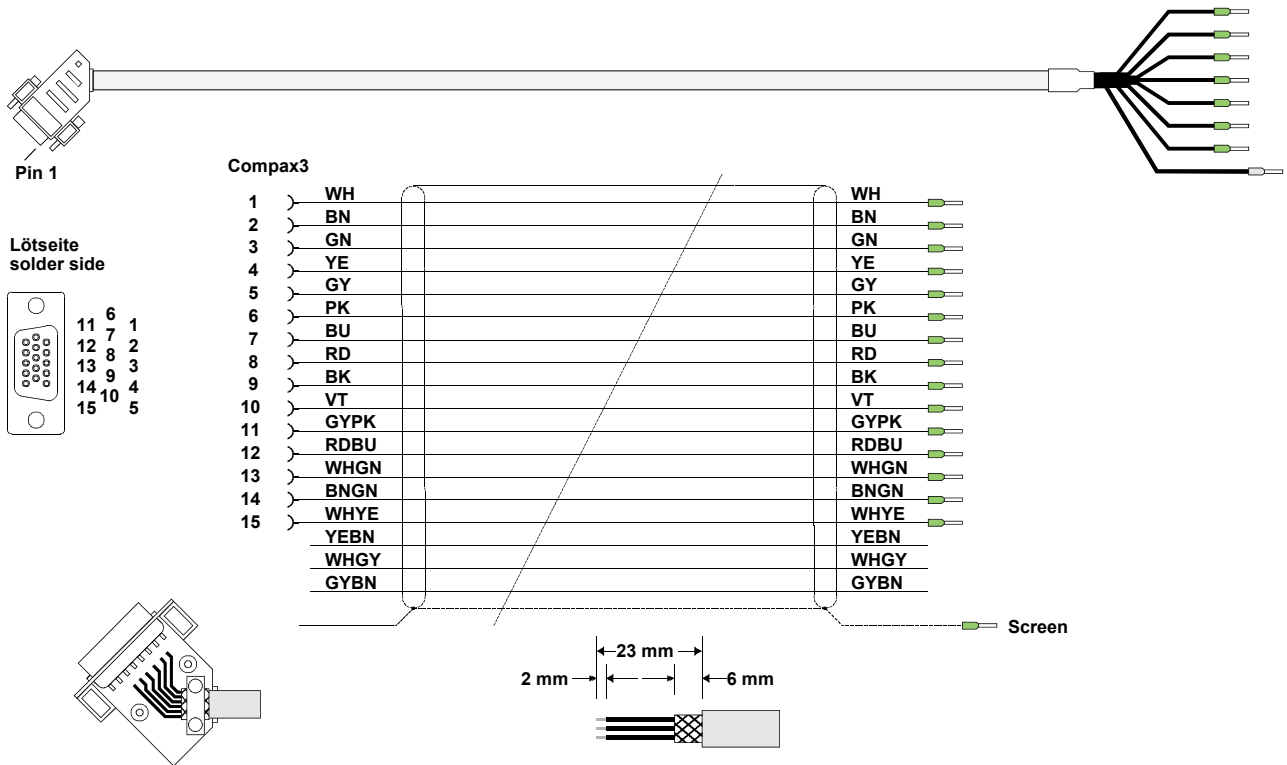

You will find the length code in the **accessories order code** (see on page 304).

10.8.4. Ref X11 / SSK21

SSK21/...: Cable for X11 with flying leads

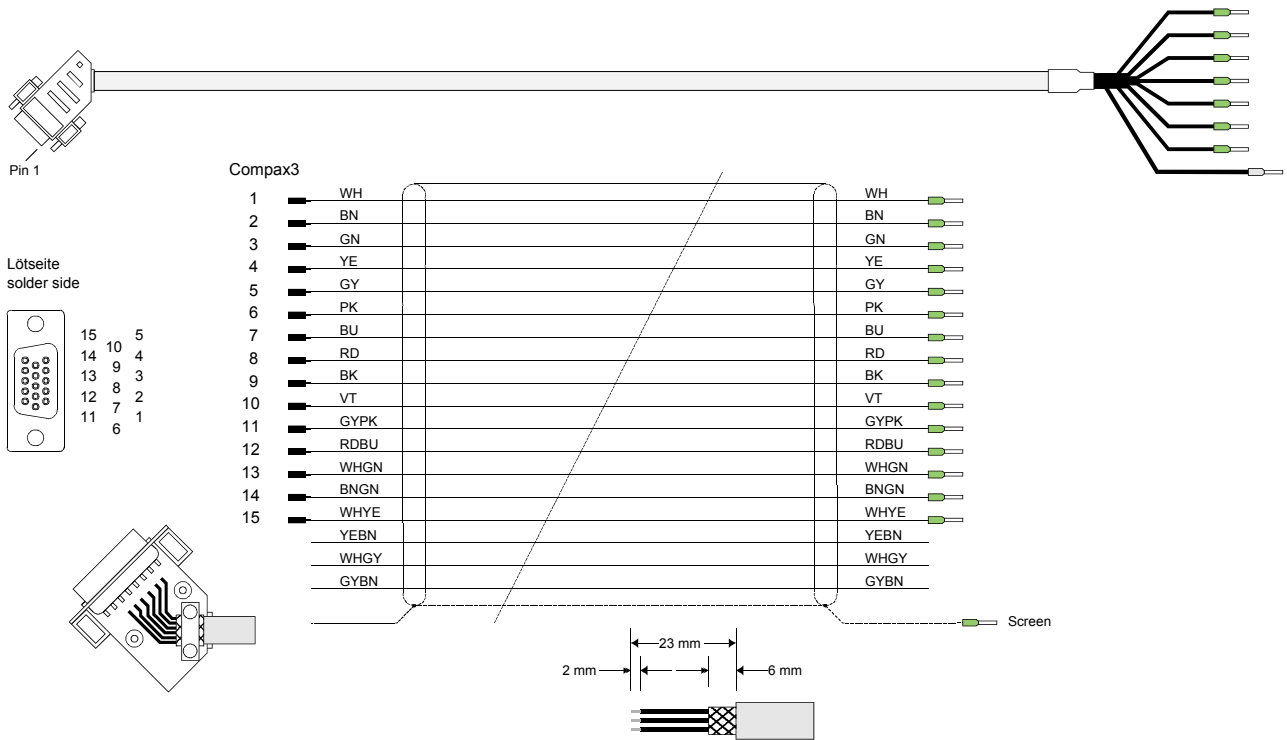

You will find the length code in the **accessories order code** (see on page 304).

10.8.5. Encoder coupling of 2 Compax3 axes / SSK29

SSK29/...: Cable from Compax3 X11 to Compax3 X11

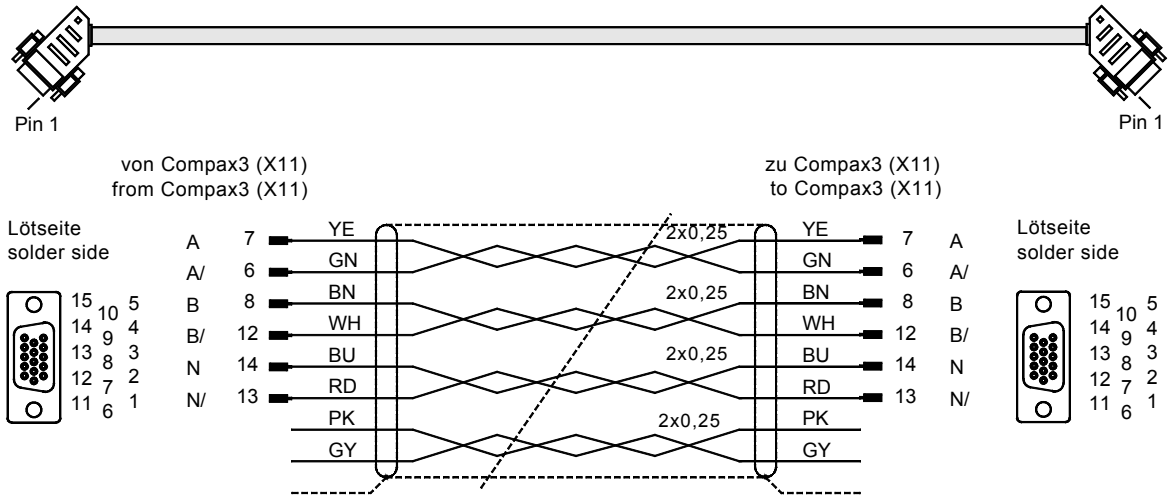

Schirm großflächig auf Gehäuse legen
Place sheath over large area of housing

Schirm großflächig auf Gehäuse legen
Place sheath over large area of housing

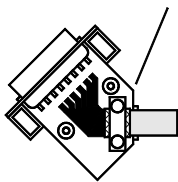

- 1 NC
- 2 NC
- 3 NC
- 4 NC
- 5 NC
- 9 NC
- 10 NC
- 11 NC
- 15 NC

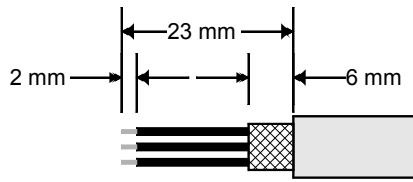

- NC 1
- NC 2
- NC 3
- NC 4
- NC 5
- NC 9
- NC 10
- NC 11
- NC 15

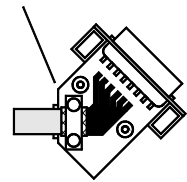

You will find the length code in the **accessories order code** (see on page 304).

Compax3 HEDA ⇔ Compax3 HEDA or PC ⇔ C3powerPLmC
Compax3 I30 ⇔ Compax3 I30 or C3M-multi axis communication

Profinet, EtherCAT, Ethernet Powerlink

Layout of SSK28:

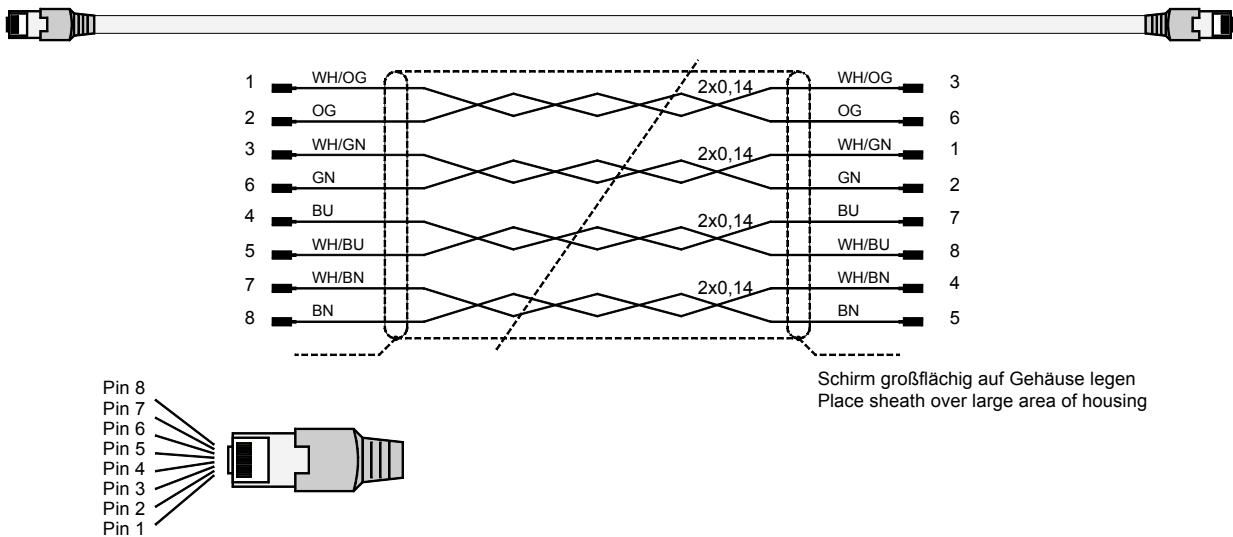

10.8.6. Modem cable SSK31

SSK31/..

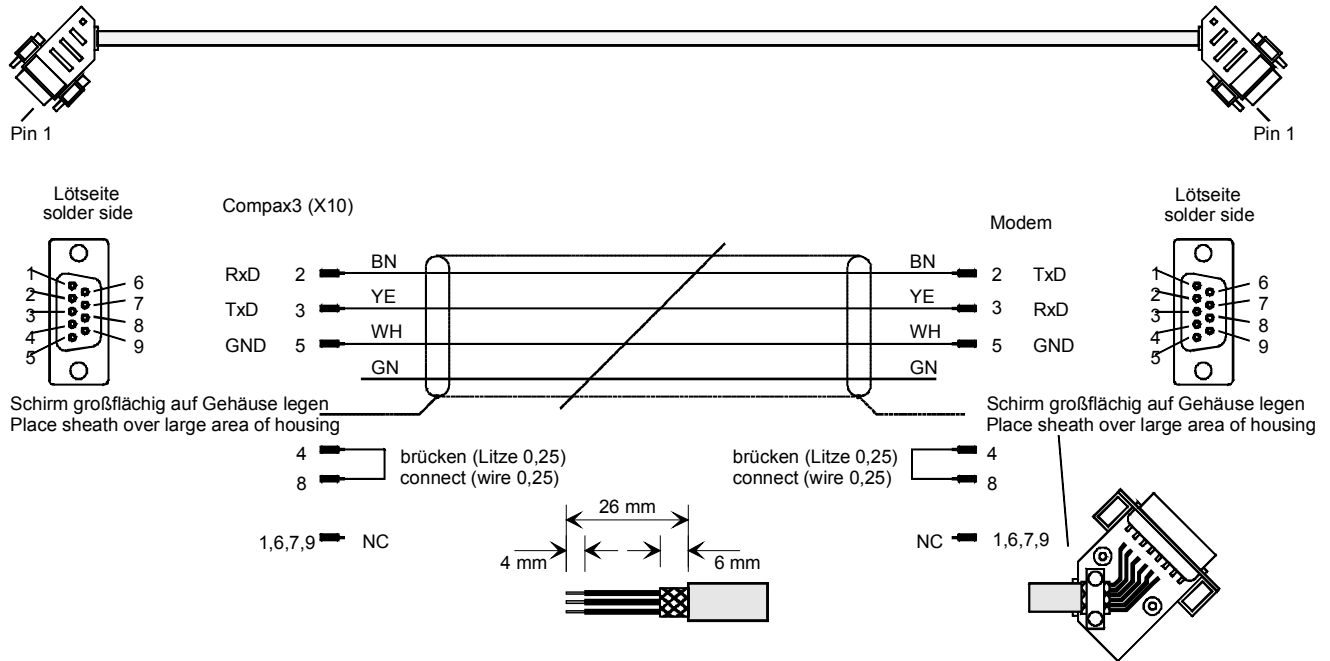

You can find the length code in the **Order Code Accessories** (see on page 304)

10.8.7. Adapter cable SSK32/20

10.9 Options M1x

In this chapter you can read about:

Digital input/output option M12 (I12) 347
 HEDA (motion bus) - Option M11 348
 Option M10 = HEDA (M11) & I/Os (M12)..... 349

10.9.1. Digital input/output option M12 (I12)

Option M12 (or M10: with HEDA) offers 8 digital 24V inputs and 4 digital outputs on X22.

10.9.1.1 Assignment of the X22 connector

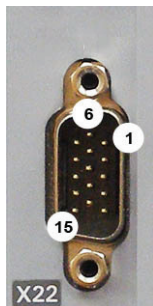

Pin X22/	Input/output	High density/Sub D
1	n.c.	factory use
2	M.I0	Address 0
3	M.I1	Address 1
4	M.I2	Address 2
5	M.I3	Address 3
6	M.I4	Address 4
7	M.I5	Start (edge triggered)
8	M.I6	no Stop (2nd Stop input)
9	M.I7	Open motor holding brake
10	M.O8	Machine zero (home) Position known
11	I	24 VDC power supply
12	M.O9	programmable status bit 0 (PSB0)
13	M.O10	programmable status bit 1 (PSB1)
14	M.O11	programmable status bit 2 (PSB2)
15	E	GND24V

* free assignment at operation via RS232 / RS485 as well as configurable in groups of 4 as inputs or outputs (C3 ServoManager).

- ◆ All inputs and outputs have 24V level.
- ◆ The input/output designation **M.I0** ... helps to make the distinction between the standard I/Os on X12 and the inputs/outputs of the **M** options.
- ◆ Maximum load on an output: 100mA
- ◆ Maximum capacitive load: 50nF (max. 4 Compax3 inputs)

Caution! The 24VDC power supply (X22/11) must be supplied from an external source and must be protected by a 1.2A delayed fuse!

Input wiring of digital inputs

SPS/PLC

Compax3

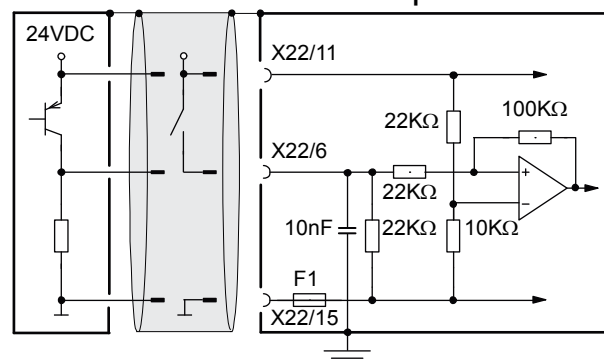

The circuit example is valid for all digital inputs!

F1: Quick action electronic fuse; can be reset by switching the 24VDC supply off and on again.

Connections of digital inputs and outputs M10 & M12

Input wiring of digital inputs

SPS/PLC

Compax3

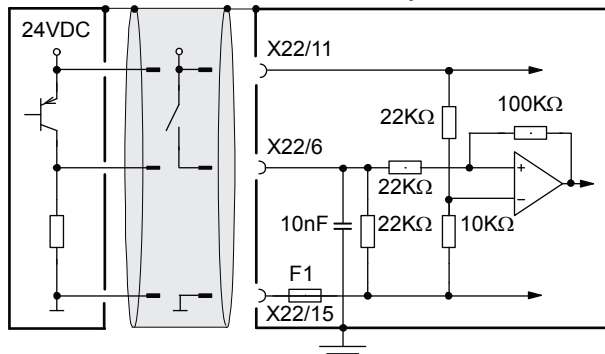

Output wiring of digital outputs

Compax3

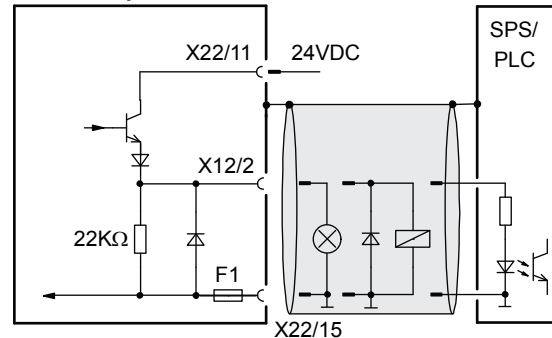

The outputs are short circuit proof; a short circuit generates an error.

F1: Quick action electronic fuse; can be reset by switching the 24VDC supply off and on again.

10.9.2. HEDA (motion bus) - Option M11

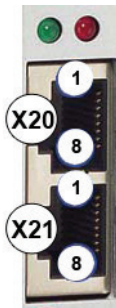

	RJ45 (X20)	RJ45 (X21)
Pin	HEDA in	HEDA out
1	Rx	Tx
2	Rx/	Tx/
3	Lx	Lx
4	-	factory use
5	-	factory use
6	Lx/	Lx/
7	-	factory use
8	-	factory use

Function of the HEDA LEDs

Green LED (left)

HEDA module energized

Red LED (right)

Error in the receive area

Possible causes:

- ◆ at the Master
 - ◆ no slave sending back
 - ◆ Wrong cabling
 - ◆ Terminal plug is missing
 - ◆ several masters are sending in the same slot
- ◆ at the slave
 - ◆ several masters in the system
 - ◆ no master active
 - ◆ Terminal plug is missing
 - ◆ no transmission from one or several receive slots (neither by the master nor by another slave)

HEDA-wiring:
HEDA-Master



Layout of SSK28 (see on page 306, see on page 345)

Design of the HEDA bus terminator BUS 07/01:

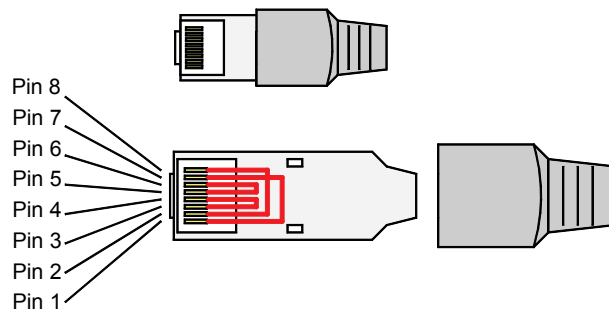

Jumpers: 1-7, 2-8, 3-4, 5-6

Function of the HEDA LEDs

Green LED (left)

HEDA module energized

Red LED (right)

Error in the receive area

Possible causes:

- ◆ at the Master
 - ◆ no slave sending back
 - ◆ Wrong cabling
 - ◆ Terminal plug is missing
 - ◆ several masters are sending in the same slot
- ◆ at the slave
 - ◆ several masters in the system
 - ◆ no master active
 - ◆ Terminal plug is missing
 - ◆ no transmission from one or several receive slots (neither by the master nor by another slave)

10.9.3. Option M10 = HEDA (M11) & I/Os (M12)

The M10 option includes the M12 input/output option and the HEDA M11 option.

11. Technical Data

Mains connection Compax3S0xxV2 1AC

Controller type	S025V2	S063V2
Continuous working voltage	Single phase 230VAC/240VAC 80-253VAC / 50-60Hz	
Receiver current consumption	6Arms	13Arms
Maximum fuse rating per device	10 A (automatic circuit breaker K)	16A (automatic circuit breaker K)

Mains connection Compax3S1xxV2 3AC

Controller type	S100V2	S150V2
Supply voltage	Three phase 3* 230VAC/240VAC 80-253VAC / 50-60Hz	
Input current	10Arms	13Arms
Maximum fuse rating per device	16A	20A
	MCB miniature circuit breaker, K characteristic	

Mains connection Compax3SxxxV4 3AC

Controller type	S015V4	S038V4	S075V4	S150V4	S300V4
Continuous working voltage	Three phase 3*400VAC/480VAC 80-528VAC / 50-60Hz				
Receiver current consumption	3Aeff	6Arms	10Arms	16Arms	22Arms
Maximum fuse rating per device	6A	10A	16A	20A	25A
	MCB miniature circuit breaker, K characteristic				D*

Mains connection PSUP10D6

Device type PSUP10	230V	400V	480V
Supply voltage	230VAC ±10% 50-60Hz	400VAC ±10% 50-60Hz	480VAC ±10% 50-60Hz
Rated voltage	3AC 230V	3AC 400V	3AC 480V
Input current	22Arms	22Arms	18Arms
Output Voltage	325VDC ±10%	565VDC ±10%	680VDC ±10%
Output power	6kW	10 kW	10 kW
Pulse power (<5s)	12kW	20kW	20kW
Heat dissipation	60W	60W	60W
Maximum fuse rating per device	Measure for line and device protection: MCB miniature circuit breaker (K characteristic) 25A in accordance with UL category DIVQ Recommendation: (ABB) S203UP-K25 (480VAC)		

Mains connection PSUP20D6

Device type PSUP20	230V	400V	480V
Supply voltage	230VAC ±10% 50-60Hz	400VAC ±10% 50-60Hz	480VAC ±10% 50-60Hz
Rated voltage	3AC 230V	3AC 400V	3AC 480V
Input current	44Arms	44Arms	35Arms
Output Voltage	325VDC ±10%	565VDC ±10%	680VDC ±10%
Output power	12kW	20kW	20kW
Pulse power (<5s)	24kW	40kW	40kW
Heat dissipation	120W	120W	120W
Maximum fuse rating per device 2 special purpose fuses in line are required	Cable protection measure: MCB (K characteristic) with a rating of 50A / 4xxVAC (depending on the input voltage) Recommendation: (ABB) S203U-K50 (440VAC) Device protection measure: Circuit breakers 80A / 700VAC per supply leg in accordance with UL category JFHR2 Requirement: Bussmann 170M1366 or 170M1566D		

PSUP30D6 Mains connection

Device type PSUP30	230V	400V	480V
Supply voltage	230VAC ±10% 50-60Hz	400VAC ±10% 50-60Hz	480VAC ±10% 50-60Hz
Rated voltage	3AC 230V	3AC 400V	3AC 480V
Input current	50Arms	50Arms	42Arms
Output Voltage	325VDC ±10%	565VDC ±10%	680VDC ±10%
Output power	17kW	30kW	30kW
Pulse power (<5s)	34kW	60kW	60kW
Heat dissipation	140W	140W	140W
Maximum fuse rating per device 2 special purpose fuses in line are required	Cable protection measure: MCB (K characteristic) with a rating of 63A / 4xxVAC (depending on the input voltage) Recommendation: (ABB) S203U-K63 (440VAC) Device protection measure: Circuit breakers 125A / 700VAC per supply leg in accordance with UL category JFHR2 Requirement: Bussmann 170M1368 or 170M1568D		

Mains connection Compax3HxxxV4 3*400VAC

Device type Compax3	H050V4	H090V4	H125V4	H155V4
Continuous working voltage	Three-phase 3*400VAC 350-528VAC / 50-60Hz			
Receiver current consumption	66Arms	95Arms	143Arms	164Arms
Output current	50Arms	90Arms	125Arms	155Arms
Maximum input fuse rating per device	80A	100A	160A	200A
Recommended line protection in accordance with UL	JDDZ Class K5 or H JDRX Class H			

Mains connection Compax3HxxxV4 3*480VAC

Device type Compax3	H050V4	H090V4	H125V4	H155V4
Continuous working voltage	Three-phase 3*480VAC 350-528VAC / 50-60Hz			
Receiver current consumption	54Arms	82Arms	118Arms	140Arms
Output current	43Arms	85Arms	110Arms	132Arms
Maximum input fuse rating per device	80A	100A	160A	200A
Recommended line protection in accordance with UL	JDDZ Class K5 or H JDRX Class H			

Control voltage 24VDC Compax3S and Compax3H

Controller type	Compax3
Voltage range	21 - 27VDC
Current drain of the device	0.8 A
Total current drain	0.8 A + Total load of the digital outputs + current for the motor holding brake
Ripple	0.5Vpp
Requirement according to safe extra low voltage (SELV)	yes
Short-circuit proof	conditional (internally protected with 3.15AT)

Control voltage 24 VDC PSUP

Device type	PSUP
Voltage range	21 - 27VDC
Ripple	0.5Vpp
Requirement according to safe extra low voltage (SELV)	yes (class 2 mains module)
Current drain PSUP	PSUP10: 0.2A PSUP20 / PSUP30: 0.3A
Electric current drain Compax3M	C3M050D6: 0.85 3M100D6: 0.85A C3M150D6: 0.85A C3M300D6: 1.0 A + Total load of the digital outputs + current for the motor holding brake

Output data Compax3S0xx at 1*230VAC/240VAC

Controller type	S025V2	S063V2
Output voltage	3x 0-240V	3x 0-240V
Nominal output current	2.5Arms	6.3Arms
Pulse current for 5s	5.5Arms	12.6Arms
Power	1kVA	2.5kVA
Switching frequency	16kHz	16kHz
Power loss for In	30W	60W

Output data Compax3S1xx at 3*230VAC/240VAC

Controller type	S100V2	S150V2
Output voltage	3x 0-240V	3x 0-240V
Nominal output current	10Arms	15Arms
Pulse current for 5s	20Arms	30Arms
Power	4kVA	6kVA
Switching frequency	16kHz	8kHz
Power loss for In	80W	130W

Output data Compax3Sxxx at 3*400VAC

Controller type	S015V4	S038V4	S075V4	S150V4	S300V4
Output voltage	3x 0-400V				
Nominal output current	1.5Arms	3.8Arms	7.5Arms	15Arms	30Arms
Pulse current for 5s	4.5Arms	9.0Arms	15Arms	30Arms	60Arms*
Power	1kVA	2.5kVA	5kVA	10kVA	20kVA
Switching frequency	16kHz	16kHz	16kHz	8kHz	8kHz
Power loss for In	60W	80W	120W	160W	350W

* With cyclic peak currents (S8 or S9 operation), the device utilization (683.2) may not be > 70%; otherwise it is necessary to use a condenser module "**C4Module** (see on page 338)".

Output data Compax3Sxxx at 3*480VAC

Controller type	S015V4	S038V4	S075V4	S150V4	S300V4
Output voltage	3x 0-480V				
Nominal output current	1.5Arms	3.8Arms	6.5Arms	13.9Arms	30Arms
Pulse current for 5s	4.5Arms	7.5Arms	15Arms	30Arms	60Arms*
Power	1.25kVA	3.1kVA	6.2kVA	11.5kVA	25kVA
Switching frequency	16kHz	16kHz	16kHz	8kHz	8kHz
Power loss for In	60W	80W	120W	160W	350W

* With cyclic peak currents (S8 or S9 operation), the device utilization (683.2) may not be > 70%; otherwise it is necessary to use a condenser module "**C4Module** (see on page 338)".

Output data Compax3Mxxx at 3*230VAC

Device type Compax3	M050D6	M100D6	M150D6	M300D6
Input Voltage	325VDC ±10%			
Output Voltage	3x 0-230V (0...500Hz)			
Output nominal current	5Arms	10Arms	15Arms	30Arms
Pulse current for 5s*	10Arms	20Arms	30Arms	60Arms
Power	2kVA	4kVA	6kVA	12kVA
Switching frequency of the motor current	8kHz	8kHz	8kHz	8kHz
Heat dissipation for In	70W+**	90W+**	120W+**	270W+**

* Turning frequency for pulse current: $f > 5$ Hz; with an electrical turning frequency of $f < 5$ Hz, the maximum pulse current time is 100ms

** Maximum additional losses with option card 5 W.

Output data Compax3Mxxx at 3*400VAC

Device type Compax3	M050D6	M100D6	M150D6	M300D6
Input Voltage	565VDC ±10%			
Output Voltage	3x 0-400V (0...500Hz)			
Output nominal current	5Arms	10Arms	15Arms	30Arms
Pulse current for 5s*	10Arms	20Arms	30Arms	60Arms
Power	3.33kVA	6.66kVA	10kVA	20kVA
Switching frequency of the motor current	8kHz	8kHz	8kHz	8kHz
Heat dissipation for In	70W+**	90W+**	120W+**	270W+**

* Turning frequency for pulse current: f>5 Hz; with an electrical turning frequency of f<5 Hz, the maximum pulse current time is 100ms

** Maximum additional losses with option card 5 W.

Output data Compax3Mxxx at 3*480VAC

Device type Compax3	M050D6	M100D6	M150D6	M300D6
Input Voltage	680VDC ±10%			
Output Voltage	3x 0-480V (0...500Hz)			
Output nominal current	4Arms	8Arms	12.5Arms	25Arms
Pulse current for 5s*	8Arms	16Arms	25Arms	50Arms
Power	3.33kVA	6.66kVA	10kVA	20kVA
Switching frequency of the motor current	8kHz	8kHz	8kHz	8kHz
Heat dissipation for In	70W+**	90W+**	120W+**	270W+**

* Turning frequency for pulse current: f>5 Hz; with an electrical turning frequency of f<5 Hz, the maximum pulse current time is 100ms

** Maximum additional losses with option card 5 W.

Output data Compax3Hxxx at 3*400VAC

Controller type	H050V4	H090V4	H125V4	H155V4
Output voltage	3x 0-400V			
Nominal output current	50Arms	90Arms	125Arms	155Arms
Pulse current for 5s *	75Arms	135Arms	187.5Arms	232.5Arms
Power	35kVA	62kVA	86kVA	107kVA
Switching frequency	8kHz	8kHz	8kHz	8kHz
Power loss for In	880W	900W	1690W	1970W

* during low speeds, the overload time is reduced to 1s. Limit:

< 2.5 electric rev/s (= actual revolutions/s * number of pole pairs) resp. >2.5 pitch/s

Output data Compax3Hxxx at 3*480VAC

Controller type	H050V4	H090V4	H125V4	H155V4
Output voltage	3x 0-480V			
Nominal output current	43Arms	85Arms	110Arms	132Arms
Pulse current for 5s*	64.5Arms	127.5Arms	165Arms	198Arms
Power	35kVA	70kVA	91kVA	109kVA
Switching frequency	8kHz	8kHz	8kHz	8kHz
Power loss for In	850W	1103W	1520W	1800W

* during low speeds, the overload time is reduced to 1s. Limit:

< 2.5 electric rev/s (= actual revolutions/s * number of pole pairs) resp. >2.5 pitch/s

Resulting nominal and peak currents depending on the switching frequency

Compax3S0xxV2 at 1*230VAC/240VAC

Switching frequency*		S025V2	S063V2
16kHz	I_{nom}	2.5A _{rms}	6.3A _{rms}
	$I_{peak} (<5s)$	5.5A _{rms}	12.6A _{rms}
32kHz	I_{nom}	2.5A _{rms}	5.5A _{rms}
	$I_{peak} (<5s)$	5.5A _{rms}	12.6A _{rms}

Compax3S1xxV2 at 3*230VAC/240VAC

Switching frequency*		S100V2	S150V2
8kHz	I_{nom}	-	15A _{rms}
	$I_{peak} (<5s)$	-	30A _{rms}
16kHz	I_{nom}	10A _{rms}	12.5A _{rms}
	$I_{peak} (<5s)$	20A _{rms}	25A _{rms}
32kHz	I_{nom}	8A _{rms}	10A _{rms}
	$I_{peak} (<5s)$	16A _{rms}	20A _{rms}

Compax3S0xxV4 at 3*400VAC

Switching frequency*		S015V4	S038V4	S075V4	S150V4	S300V4
8kHz	I_{nom}	-	-	-	15A _{rms}	30A _{rms}
	$I_{peak} (<5s)$	-	-	-	30A _{rms}	60A _{rms}
16kHz	I_{nom}	1.5A _{rms}	3.8A _{rms}	7.5A _{rms}	10.0A _{rms}	26A _{rms}
	$I_{peak} (<5s)$	4.5A _{rms}	9.0A _{rms}	15.0A _{rms}	20.0A _{rms}	52A _{rms}
32kHz	I_{nom}	1.5A _{rms}	2.5A _{rms}	3.7A _{rms}	5.0A _{rms}	14A _{rms}
	$I_{peak} (<5s)$	3.0A _{rms}	5.0A _{rms}	10.0A _{rms}	10.0A _{rms}	28A _{rms}

Compax3S0xxV4 at 3*480VAC

Switching frequency*		S015V4	S038V4	S075V4	S150V4	S300V4
8kHz	I_{nom}	-	-	-	13.9A _{rms}	30A _{rms}
	$I_{peak} (<5s)$	-	-	-	30A _{rms}	60A _{rms}
16kHz	I_{nom}	1.5A _{rms}	3.8A _{rms}	6.5A _{rms}	8.0A _{rms}	21.5A _{rms}
	$I_{peak} (<5s)$	4.5A _{rms}	7.5A _{rms}	15.0A _{rms}	16.0A _{rms}	43A _{rms}
32kHz	I_{nom}	1.0A _{rms}	2.0A _{rms}	2.7A _{rms}	3.5A _{rms}	10A _{rms}
	$I_{peak} (<5s)$	2.0A _{rms}	4.0A _{rms}	8.0A _{rms}	7.0A _{rms}	20A _{rms}

The values marked with grey are the pre-set values (standard values)!
*corresponds to the frequency of the motor current

Resulting nominal and peak currents depending on the switching frequency

Compax3MxxxD6 at 3*400VAC

Switching frequency*		M050D6	M100D6	M150D6	M300D6
8kHz	I_{nom}	5A _{rms}	10A _{rms}	15A _{rms}	30A _{rms}
	$I_{peak} (<5s)$	10A _{rms}	20A _{rms}	30A _{rms}	60A _{rms}
16kHz	I_{nom}	3.8A _{rms}	7.5A _{rms}	10A _{rms}	20A _{rms}
	$I_{peak} (<5s)$	7.5A _{rms}	15A _{rms}	20A _{rms}	40A _{rms}
32kHz	I_{nom}	2.5A _{rms}	3.8A _{rms}	5A _{rms}	11A _{rms}
	$I_{peak} (<5s)$	5A _{rms}	7.5A _{rms}	10A _{rms}	22A _{rms}

Compax3MxxxD6 at 3*480VAC

Switching frequency*		M050D6	M100D6	M150D6	M300D6
8kHz	I_{nom}	4A _{rms}	8A _{rms}	12.5A _{rms}	25A _{rms}
	$I_{peak} (<5s)$	8A _{rms}	16A _{rms}	25A _{rms}	50A _{rms}
16kHz	I_{nom}	3A _{rms}	5.5A _{rms}	8A _{rms}	15A _{rms}
	$I_{peak} (<5s)$	6A _{rms}	11A _{rms}	16A _{rms}	30A _{rms}
32kHz	I_{nom}	2A _{rms}	2.5A _{rms}	4A _{rms}	8.5A _{rms}
	$I_{peak} (<5s)$	4A _{rms}	5A _{rms}	8A _{rms}	17A _{rms}

The values marked with grey are the pre-set values (standard values)!
*corresponds to the frequency of the motor current

Resulting nominal and peak currents depending on the switching frequency

Compax3HxxxV4 at 3*400VAC

Switching frequency*		H050V4	H090V4	H125V4	H155V4
8kHz	I_{nom}	50A _{rms}	90A _{rms}	125A _{rms}	155A _{rms}
	$I_{peak} (<5s)$	75A _{rms}	135A _{rms}	187.5A _{rms}	232.5A _{rms}
16kHz	I_{nom}	33A _{rms}	75A _{rms}	82A _{rms}	100A _{rms}
	$I_{peak} (<5s)$	49.5A _{rms}	112.5A _{rms}	123A _{rms}	150A _{rms}
32kHz	I_{nom}	19A _{rms}	45A _{rms}	49A _{rms}	59A _{rms}
	$I_{peak} (<5s)$	28.5A _{rms}	67.5A _{rms}	73.5A _{rms}	88.5A _{rms}

Compax3HxxxV4 at 3*480VAC

Switching frequency*		H050V4	H090V4	H125V4	H155V4
8kHz	I_{nom}	43A _{rms}	85A _{rms}	110A _{rms}	132A _{rms}
	$I_{peak} (<5s)$	64.5A _{rms}	127.5A _{rms}	165A _{rms}	198A _{rms}
16kHz	I_{nom}	27A _{rms}	70A _{rms}	70A _{rms}	84A _{rms}
	$I_{peak} (<5s)$	40.5A _{rms}	105A _{rms}	105A _{rms}	126A _{rms}
32kHz	I_{nom}	16A _{rms}	40A _{rms}	40A _{rms}	48A _{rms}
	$I_{peak} (<5s)$	24A _{rms}	60A _{rms}	60A _{rms}	72A _{rms}

The values marked with grey are the pre-set values (standard values)!
*corresponds to the frequency of the motor current

Resolution of the motor position

For option F10: Resolver	<ul style="list-style-type: none"> ◆ Position resolution: 16 Bits (= 0.005°) ◆ Absolute accuracy: ±0.167°
For option F11: SinCos®	<ul style="list-style-type: none"> ◆ Position resolution: 13.5 Bits / Encoder sine period => 0.03107°/encoder resolution
For option F12:	<ul style="list-style-type: none"> ◆ Maximum position resolution <ul style="list-style-type: none"> ◆ Linear: 24 Bits per motor magnet spacing ◆ Rotary: 24 Bits per motor revolution ◆ For 1Vss Sine-Cosine encoders (e.g. EnDat): 13.5 bits / graduation of the scale of the encoder ◆ For RS 422 encoders: 4x encoder resolution ◆ Accuracy of the feedback zero pulse acquisition = accuracy of the feedback resolution. ◆ Resolution for analog hall sensors with 1Vpp signal: 13.5 Bits / motor magnet spacing

Accuracy

The exactitude of the position signal is above all determined by the exactitude of the feedback system used.

Supported Motor and Feedback Systems

Motors Direct drives ◆ Linear motors ◆ Torque motors	<ul style="list-style-type: none"> ◆ Sinusoidally commutated synchronous motors <ul style="list-style-type: none"> ◆ Maximum electrical turning frequency: 1000Hz* ◆ Max. velocity on 8 pole motors: 15 000min⁻¹. ◆ General max. speed: 60*1000/number of pole pairs in [min⁻¹]. ◆ Max. number of poles = 600 ◆ Sinusoidal commutated asynchronous motors <ul style="list-style-type: none"> ◆ Maximum electrical turning frequency: 1000Hz ◆ Max. velocity: 60*1000/number of pole pairs - slip in [min⁻¹]. ◆ Field weakening: typically up to triple (higher on request). ◆ Temperature sensor: KTY84-130 (insulated in accordance with EN60664-1 or IEC60664-1) ◆ 3 phase synchronous direct drives
Position encoder (Feedback)	Option F10: Resolver
LTN:	◆ RE-21-1-A05, RE-15-1-B04
Tamagawa:	◆ TS2610N171E64, TS2620N21E11, TS2640N321E64, TS2660N31E64
Tyco (AMP)	◆ V23401-T2009-B202
	Option F11: SinCos®
	<ul style="list-style-type: none"> ◆ Rotary feedback with HIPERFACE® interface: <ul style="list-style-type: none"> ◆ Singleturn (SICK Stegmann) ◆ Multiturn (SICK Stegmann) Absolute position up to 4096 motor revolutions. ◆ For example: SRS50, SRM50, SKS36, SKM36, SEK52, SEK52, SEL52, SEK37, SEL37, SEK160, SEK90

* higher values on request

Special Feedback Systems	Option F12
Analog hall sensors	<ul style="list-style-type: none"> ◆ Sine-Cosine signal (max. 5Vpp*; typical 1Vpp) 90° offset ◆ U-V signal (max. 5Vpp*; typical 1Vpp) 120° offset.
Encoder (linear or rotary)	<ul style="list-style-type: none"> ◆ Sine-Cosine (max. 5Vpp*; typical 1Vpp) (max. 400kHz) or ◆ TTL (RS422) (max. 5MHz; track A or B) ◆ Bypass function for encoder signals (limit frequency** 5MHz, track A or B) with the following modes of commutation: <ul style="list-style-type: none"> ◆ Automatic commutation (see on page 310) or ◆ U, V, W or R, S, T commutation signals (NPN open collector) e.g. digital hall sensors, incremental encoders made by Hengstler (F series with electrical ordering variant 6)
EnDat*** with incremental (Sine - Cosine) track	<ul style="list-style-type: none"> ◆ EnDat 2.1 or EnDat 2.2 (Endat01, Endat02) feedback ◆ linear or rotary ◆ max. 400kHz Sine-Cosine
EnDat 2.2*** (fully digital)	<ul style="list-style-type: none"> ◆ EnDat 2.2 (Endat01, Endat02) feedback ◆ linear or rotary ◆ max. Cable length: 25 m
EnDat2.1*** (fully digital)	<ul style="list-style-type: none"> ◆ EnDat 2.1 without incremental track ◆ Supported types: EQI11xx, ECI11xx, ECI11x ◆ max. Cable length: 90 m
Distance coded feedback systems	<ul style="list-style-type: none"> ◆ Distance coding with 1 VSS interface ◆ Distance coding with RS422 - Interface (Encoder)

*Max. differential input between SIN- (X13/7) and SIN+ (X13/8).

** Limit frequency = 1MHz for Compax3M (higher bandwidths on request)

*** Digital, bidirectional interface

Feedback error compensation

Feedback error compensation	<ul style="list-style-type: none"> ◆ Automatic feedback error compensation (offset & amplification) for analog hall sensors and sine-cosine encoder can be activated in the MotorManager.
-----------------------------	--

Motor holding brake output

Motor holding brake output	Compax3
Voltage range	21 – 27VDC
Maximum output current (short circuit proof)	1.6A
Securing of brake Compax3M	3.15A

Braking operation Compax3S0xxV2 1AC

Controller type	S025V2	S063V2
Capacitance / storable energy	560µF / 15Ws	1120µF / 30Ws
Minimum braking- resistance	100Ω	56Ω
Recommended nominal power rating	20 ... 60W	60 ... 180W
Maximum continuous current	8A	15A

Braking operation Compax3S1xxV2 3AC

Controller type	S100V2	S150V2
Capacitance / storable energy	780µF / 21Ws	1170µF / 31Ws
Minimum braking- resistance	22Ω	15Ω
Recommended nominal power rating	60 ... 450W	60 ... 600W
Maximum continuous current	20A	20A

Braking operation Compax3SxxxV4 3AC

Controller type	S015V4	S038V4	S075V4	S150V4	S300V4
Capacity / storable energy 400V / 480V	235 μ F 37 / 21 Ws	235 μ F 37 / 21 Ws	470 μ F 75 / 42 Ws	690 μ F 110 / 61 Ws	1230 μ F 176 / 98 Ws
Minimum ballast - resistance	100 Ω	100 Ω	56 Ω	47 Ω	15 Ω
Recommended nominal power rating	60 ... 100W	60 ... 250W	60 ... 500 W	60 ... 1000 W	60 ... 1000 W
Maximum continuous current	10A	10A	15A	20A	30A

Braking operation Compax3MxxxD6 (axis controller)

Device type Compax3	M050	M100	M150	M300
Capacity/ storable energy	110 μ F/ 18Ws at 400V 10Ws at 480V	220 μ F/ 37Ws at 400V 21Ws at 480V	220 μ F/ 37Ws at 400V 21Ws at 480V	440 μ F/ 74Ws at 400V 42Ws at 480V

Braking operation of Compax3HxxxV4

Controller type	H050V4	H090V4	H125V4	H155V4
Capacitance / storable energy 400V / 480V	2600 μ F 602 / 419 Ws	3150 μ F 729 / 507 Ws	5000 μ F 1158 / 806 Ws	5000 μ F 1158 / 806 Ws
Minimum braking- resistance	24 Ω	15 Ω	8 Ω	8 Ω
Maximum continuous current	11 A	17 A	31 A	31 A

Braking operation PSUPxxD6 (mains module)

Device type	PSUP10	PSUP20	PSUP30
Capacitance / storable energy	550 μ F/ 92 Ws at 400 V 53 Ws at 480 V	1175 μ F/ 197 Ws at 400 V 114 Ws at 480 V	1175 μ F/ 197 Ws at 400 V 114 Ws at 480 V
Minimum braking- resistance	27 Ω	15 Ω	10 Ω
Recommended nominal power rating	500 ... 1500 W	500 ... 3500 W	500 ... 5000 W
Pulse power rating for 1s	22 kW	40 kW	60 kW
Maximum permissible continuous current	13 A	15 A	15 A

Ballast resistors Compax3

Ballast resistor (see on page 325)	Device	Nominal Power
BRM08/01 (100 Ω)	Compax3S025V2 Compax3S015V4 Compax3S038V4	60 W
BRM05/01 (56 Ω)	Compax3S063V2 Compax3S075V4	180 W
BRM05/02 (56 Ω)	Compax3S075V4	570 W
BRM10/01 (47 Ω)	Compax3S150V4	570 W
BRM10/02 (47 Ω)	Compax3S150V4	1500 kW
BRM04/01 (15 Ω)	Compax3S150V2 Compax3S300V4 PSUP20D6	570 W
BRM04/02 (15 Ω)	Compax3S150V2 Compax3S300V4 PSUP20D6	740 W
BRM04/03 (15 Ω)	Compax3S300V4 PSUP20D6	1500 W
BRM09/01 (22 Ω)	Compax3S100V2	570 W
BRM11/01 (27 Ω)	Compax3H0xxV4	3500 W
BRM13/01 (30 Ω)	PSUP10D6 PSUP20D6** PSUP30D6**	500 W
BRM14/01 (15 Ω)	PSUP10D6* PSUP20D6 PSUP30D6	500 W
BRM12/01 (18 Ω)	Compax3H1xxV4 PSUP30D6	4500 W

*for PSUP10D6 2x15Ω in series

**for PSUP20D6 and PSUP30D6 2x30Ω parallel

Size / weight Compax3S

Controller type	Dimensions HxWxD [mm]	Weight [kg]
Compax3S025V2	191 x 84 x 172	2.0
Compax3S063V2	191 x 100 x 172	2.5
Compax3S015V4	248 x 84 x 172	3.1
Compax3S100V2	248 x 115 x 172	4.3
Compax3S150V2	248 x 158 x 172	6.8
Compax3S038V4	248 x 100 x 172	3.5
Compax3S075V4	248 x 115 x 172	4.3
Compax3S150V4	248 x 158 x 172	6.8
Compax3S300V4	380 x 175 x 172	10.9

Minimum mounting distance: 15mm at the sides, above & below 100mm

Protection type IP20

Drawings, Mounting (see on page 66, see on page 72)

Size / weight PSUP/Compax3M

Device type	Dimensions HxWxD [mm]	Weight [kg]
PSUP10D6	360 x 50 x 263	3.95
PSUP20D6 & PSUP30D6	360 x 100 x 263	6.3
Compax3M050D6	360 x 50 x 263	3.5
Compax3M100D6	360 x 50 x 263	3.6
Compax3M150D6	360 x 50 x 263	3.6
Compax3M300D6	360 x 100 x 263	5.25

Protection type IP20**Size / weight Compax3H**

Mounting (see on page 66, see on page 72)

Controller type	Dimensions HxWxD [mm]	Weight [kg]
Compax3H050V4	453 x 252 x 245	17.4
Compax3H090V4	668.6 x 257 x 312	32.5
Compax3H125V4	720 x 257 x 355	41
Compax3H155V4	720 x 257 x 355	41

Protection class IP20 when mounted in a control cabinet (not for Compax3H1xxV4)

Digital Inputs/outputs

Digital Inputs	<ul style="list-style-type: none"> ◆ 8 digital inputs ◆ Input resistor 22 kΩ ◆ Signal level <ul style="list-style-type: none"> ◆ > 9.15V = "1" (38.2% of the control voltage applied) ◆ < 8.05V = "0" (33.5% of the control voltage applied)
Digital Outputs	<ul style="list-style-type: none"> ◆ 4 digital outputs ◆ Load max. 100mA

Safety technology Compax3S

Safe torque-off in accordance with EN ISO 13849: 2008, Category 3, PL d/e Certified. Test mark IFA 1003004	<ul style="list-style-type: none"> ◆ For implementation of the "protection against unexpected start-up" function described in EN1037. ◆ Please note the circuitry examples (see on page 75).
---	---

Compax3S STO (=safe torque off)

Nominal voltage of the inputs	24 V
Required isolation of the 24V control voltage	Grounded protective extra low voltage, PELV
Protection of the STO control voltage	1 A
Grouping of safety level	<p><500 000 STO cycles per year are assumed.</p> <ul style="list-style-type: none"> ◆ STO switch-off via internal safety relay & digital input: PL e, PFHd=2.98E-8 ◆ STO switch-off via internal safety relay & fieldbus: PL d, PFHd=1.51E-7 (is applicable for a MTTFd=15 years of the external PLC) ◆ Lifetime: 20 Years

Safety technology Compax3M

Safe torque-off in accordance with EN ISO 13849-1: 2007, Category 3, PL=e Certified. Test mark MFS 09029	◆ Please respect the stated safety technology on the type designation plate (see on page 12) and the circuitry examples (see on page 85)
---	--

Compax3M S1 Option: Signal inputs for connector X14

Nominal voltage of the inputs	24V
Required isolation of the 24V control voltage	Grounded protective extra low voltage, PELV
Protection of the STO control voltage	1A
Number of inputs Signal inputs via optocoupler	2 Low = 0...7V DC or open High = 15...30V DC I _{in} at 24V DC: 8mA
STO1/	Low = STO activated High = STO deactivated Reaction time max. 3ms
STO2/	Low = STO activated High = STO deactivated Reaction time max. 3ms
Switch-off time with unequal input statuses	20 s (max. error reaction time)
Grouping of safety level	◆ Category 3 ◆ PL=e (according to table 4 in EN ISO 13849-1 this corresponds to SIL 3) ◆ PFHd=4.29E-8 ◆ Lifetime: 20 years

UL certification for Compax3S

conform to UL:	◆ according to UL508C
Certified	◆ E-File_No.: E235342

The UL certification is documented by a "UL" logo on the device (type specification plate).



UL approval for Compax3M

Conform to UL:	◆ in accordance with UL508C
Certified	◆ E-File_No.: E235342

The UL approval is documented by a "UL" logo on the device (type specification plate).



Insulation requirements

Enclosure rating	Protection class in accordance with EN 60664-1
Protection against human contact with dangerous voltages	In accordance with EN 61800-5-1
Overvoltage category	Voltage category III in accordance with EN 60664-1
Degree of contamination	Degree of contamination 2 in accordance with EN 60664-1 and EN 61800-5-1

Environmental conditions Compax3S and Compax3H

General ambient conditions	In accordance with EN 60 721-3-1 to 3-3 Climate (temperature/humidity/barometric pressure): Class 3K3	
Permissible ambient temperature:		
Operation storage transport	0 to +45 °C class 3K3 -25 to +70 °C class 2K3 -25 to +70 °C class 2K3	
Tolerated humidity:	no condensation	
Operation storage transport	<= 85% class 3K3 <= 95% class 2K3 <= 95% class 2K3	(Relative humidity)
Elevation of operating site	<=1000m above sea level for 100% load ratings <=2000m above sea level for 1% / 100m power reduction please inquire for greater elevations	
Mechanic resonances:	EN 60068-2-6 (sinusoidal excitation)	
Sealing	Protection type IP20 in accordance with EN 60 529	

Cooling Compax3S and Compax3H

Cooling mode:	C3S025V2 ... S150V4: Convection C3S300V4 & C3H: Forced air ventilation with fan in the heat dissipator Air flow rate: 459m ³ /h (C3H)
Supply:	C3S300V4, C3H050, C3H090 internal C3H125, C3H155 external 220/240VAC: 140W, 2.5µF, Stator - 62Ω Optionally on request: 110/120VAC: 130W, 10µF, Stator - 16Ω Circuit breaker: 3A

EMC limit values Compax3S and Compax3H

EMC interference emission	Limit values in accordance with EN 61 800-3, Limit value class C3/C4 without additional mains filter: Information on C2 limit value classes (see on page 17)
EMC disturbance immunity	Industrial area limit values in accordance with EN 61 800-3

Ambient conditions PSUP/Compax3M

General ambient conditions	In accordance with EN 60 721-3-1 to 3-3 Climate (temperature/humidity/barometric pressure): Class 3K3	
Permissible ambient temperature:		
Operation	0 to +40 °C	Class 3K3
storage	-25 to +70 °C	
transport	-25 to +70 °C	
Tolerated humidity:	no condensation	
Operation	<= 85% class 3K3	(Relative humidity)
storage	<= 95%	
transport	<= 95%	
Elevation of operating site	<=1000m above sea level for 100% load ratings <=2000m above sea level for 1% / 100m power reduction please inquire for greater elevations	
Sealing	Protection type IP20 in accordance with EN 60 529	
Mechanic resonances:	Class 2M3, 20m/s ² ;8-200Hz	

Cooling PSUP/Compax3M

Cooling mode:	Forced air ventilation with fan in the heat dissipator
----------------------	--

EMV limit values PSUP/Compax3M

EMC interference emission	Limit values in accordance with EN 61 800-3, Limit value class C3 with mains filter.
EMC disturbance immunity	Industrial area limit values in accordance with EN 61 800-3

EC directives and applied harmonized EC norms

EC low voltage directive 2006/95/EG	EN 61800-5-1 , Standard for electric power drives with settable speed; requirements to electric safety EN 60664-1 , isolation coordinates for electrical equipment in low-voltage systems EN 60204-1, machinery norm partly applied
EC-EMC-directive 2004/108/EC	EN 61800-3, EMC standard Product standard for variable speed drives

COM ports

RS232	<ul style="list-style-type: none"> ◆ 115200 baud ◆ Word length: 8 bits, 1 start bit, 1 stop bit ◆ Hardware handshake XON, XOFF
RS485 (2 or 4-wire)	<ul style="list-style-type: none"> ◆ 9600, 19200, 38400, 57600 or 115200 baud ◆ Word length 7/8 bit, 1 start bit, 1 stop bit ◆ Parity (can be switched off) even/odd ◆ 2 or 4-wire
USB (Compax3M)	◆ USB 2.0 Full Speed compatible

Load position control

Dual Loop Option	◆ 2. Feedback system for load position control (see on page 153) possible.
-------------------------	---

Signal interfaces

Signal inputs / signal sources	<ul style="list-style-type: none"> ◆ Encoder input track A/B (RS422) <ul style="list-style-type: none"> ◆ up to max. 10MHz ◆ Internal quadrature of the resolution ◆ Step / direction input (24V level) Max. 300kHz at $\geq 50\Omega$ source impedance and minimum pulse width of 1.6μs. ◆ +/-10V analog input 14Bit; 62.5μs scanning rate. ◆ SSI - feedback
Signal outputs	<ul style="list-style-type: none"> ◆ Encoder simulation <ul style="list-style-type: none"> ◆ 1...16384 increments/revolution or pitch ◆ Limit frequency** 620kHz (track A or B) ◆ Bypass function for encoder feedback with feedback module F12 (Limit frequency* 5MHz, track A or B).
Signal transmission	<p>HEDA (Option M10 or M11) Transfer of process values:</p> <ul style="list-style-type: none"> ◆ from Master to Slave, ◆ from Slave to Master and ◆ from Slave to Slave.

** Limit frequency = 1MHz for Compax3M (higher bandwidths on request)

Functions

Motion control via I/Os (Option M10 or M12 required) or via RS232 / RS485	<ul style="list-style-type: none"> ◆ up to 31 motion sets possible with the following functions. <ul style="list-style-type: none"> ◆ Absolute positioning ◆ Relative positioning ◆ Electronic Gearbox (Gearing) ◆ Reg-related positioning (exactitude < 1μs) ◆ Speed control ◆ Stop - Set ◆ Definition of status bits for sequence control (with M10 or M12) ◆ ◆ Specification of speed, acceleration, deceleration and jerk ◆ Different machine zero modes ◆ Absolute / continuous operation
Actual position	<ul style="list-style-type: none"> ◆ Encoder simulation ◆ Resolution: 4 - 16384 Increments / revolution
Signal monitor	<ul style="list-style-type: none"> ◆ 2 channels ± 10 V analog ◆ Resolution: 8 Bit
8 digital inputs (24V level) (standard)	<ul style="list-style-type: none"> ◆ Energize motor/Ackn; Stop; Manual+, Manual-, Reg input, 2 limit switches, machine zero initiator,
8 additional digital inputs (with M10 or M12 Option)	<ul style="list-style-type: none"> ◆ Address 0 - 4, Start, 2. Stop, open brake, ◆ 24V level
4 digital outputs	<ul style="list-style-type: none"> ◆ Error, Position/Speed/Gear reached, power output stage currentless, motor stationary with current with setpoint value 0. ◆ Load max. 100mA
4 additional digital outputs (with M10 or M12 Option)	<ul style="list-style-type: none"> ◆ Ref detected / referenced, status bits Bit 1 - 3

12. Index

+

+/-10V analog speed setpoint value as signal source • 151

A

Absolute- /continuous mode • 135
 Absolute encoder • 104
 Absolutposition im Geber speichern • 105
 Access to the hazardous area • 84
 Acknowledge error (example) • 275
 Activation • 235
 Adapterkabel SSK32/20 • 346
 Additional conditions of utilization • 19
 Adjusting the basic address • 60
 Adjusting the machine zero proximity switch • 118
 Advanced • 200
 Advantages of using the • 76
 Alignment of the analog inputs • 231
 Allgemeine Gefahren • 14
 Analog Inputs/Outputs • 300
 Analogue / encoder (plug X11) • 63
 Analyses in the time range • 236
 Application parameters • 165
 Applikationsbeispiel STO (= Sicher abgeschaltetes Moment) • 81
 Approximation of a well-attenuated control loop • 184
 ASCII - record • 287
 Assignment of the different motion functions • 277
 Assignment of the X22 connector • 347
 Asynchronmotoren • 178
 Asynchronous motors
 Extension of the controller structure • 181
 Attenuation of the excitation amplitude • 246
 Aufbau der Satztable • 277
 Automated controller design • 191
 Automatic controller design • 182

B

Ballast resistor • 35, 99, 358
 Ballast resistor BRM13/01 & BRM14/01 • 337
 Ballastwiderstand / Leistungsspannung
 Stecker X2 bei 1AC
 230VAC/240VAC-Geräten • 35
 Basic structure of the control with Compax3 • 164
 Basics of frequency response measurement • 261
 Bedeutung der Status-LEDs - PSUP (Netzmodul) • 28
 Begrenzung der Sollgeschwindigkeit • 197
 Begrenzung des Sollstroms • 197
 Beispiel

Elektronisches Getriebe mit Lageerfassung über Encoder • 150

Bestellhinweis Kabel • 308
 Bestellschlüssel Ein-/Ausgangsklemmen (PIO) • 307
 Bestellschlüssel Feedbackkabel • 305
 Bestellschlüssel Kondensatormodul • 306
 Bestellschlüssel Netzfilter (C3S) • 306
 Bestellschlüssel Zubehör • 304
 Bewegungsobjekte in Compax3 • 228
 Bewegungszyklus ohne Vorsteuerung • 199
 Binary record • 288
 Boundary conditions • 229
 Brake delay times • 268
 Braking resistor / high voltage DC C3S connector X2 • 35
 Braking resistor / high voltage supply connector X2 for 3AC
 400VAC/480VAC_C3S devices • 37
 Braking resistor / high voltage supply plug X2 for 3AC 230VAC/240VAC devices • 35
 Braking resistor / supply voltage C3H • 57
 Braking resistor / temperature switch PSUP (mains module) • 46
 Braking resistor BRM11/01 & BRM12/01 • 337
 Braking resistor BRM4/0x and BRM10/02 • 336
 Braking resistor BRM5/02, BRM9/01 & BRM10/01 • 336
 BRM10/02 • 325, 329, 336
 BRM5/01 braking resistor • 335
 BRM8/01braking resistors • 335

C

C3 ServoSignalAnalyzer • 233
 C3 settings for RS485 four wire operation • 286
 C3 settings for RS485 two wire operation • 285
 C3I2T11 Function overview • 25
 Calculation of the BRM cooling time • 326
 Calculation of the reference current from the characteristic line. • 168
 Calling up the input simulation • 226
 Capacitors • 13
 Cascade control • 188
 Cascade structure of Compax3 • 189
 Change assignment direction reversal / limit switches • 123
 Change initiator logic • 123
 Changing the switching frequency and the reference point • 177
 Characteristics of a control loop setpoint response • 187
 Circuit layout overview • 81
 Circuit: • 82
 COM port protocol • 287
 Communication Compax3M • 59
 Communication interfaces • 58

Commutation settings of the automatic commutation • 207

Compax3 - Objekte • 295

Compax3 communication variants • 278

Compax3 device description • 27

Compax3H connections front plate • 53

Compax3H plugs/connections • 50

Compax3M STO application description • 88

Compax3S connectors • 29

Compax3Sxxx V2 • 34

Compax3Sxxx V4 • 36

Conditions of utilization • 17

Conditions of utilization for cables / motor filter • 18

Conditions of utilization for CE-conform operation • 17

Conditions of utilization for the STO function with Compax3M • 86

Conditions of utilization for UL approval Compax3M • 21

Conditions of utilization mains filter • 17

Conditions of utilization STO (=safe torque off) Safety function • 80

Configuration name / comments • 147

Configuration of load control • 154

Configuration of local modem 1 • 293

Configuration of remote modem 2 • 294

Configuring the signal Source • 148

Connect braking resistor C3H • 57

Connection of a braking resistor • 35, 37

Connection of terminal box MH145 & MH205 • 323

Connection of the digital Outputs/Inputs • 65

Connection of the power voltage • 51

Connection of the power voltage of 2 C3H 3AC devices • 57

Connection of the power voltage of 2 C3S 3AC devices • 37

Connections of Compax3H • 50

Connections of Compax3S • 29

Connections of digital inputs and outputs M10 & M12 • 348

Connections of the axis combination • 42

Connections of the encoder interface • 63

Connections on the device bottom • 41

Connections to the motor • 320

Control path • 166

Control structures • 195, 200, 202

Control signal filter / filter of actual acceleration value • 200

Control signal limitations • 196

Control via RS232 / RS485 / USB • 269

Control voltage 24 VDC • 32

Control voltage 24 VDC C3H • 56

Control voltage 24VDC / enable connector X4 C3S • 32

Control voltage 24VDC PSUP (mains module) • 43

Control word (example) • 275

Controller coefficients • 192

Controller optimization • 164

Controller optimization Advanced • 222

Controller optimization disturbance and setpoint behavior (advanced) • 221

Controller optimization disturbance and setpoint behavior (standard) • 219

Controller optimization guiding transmission behavior • 224

Controller optimization of toothed belt drive • 220

Controller optimization standard • 219

Correlation between the terms introduced • 191

Course of the automatic commutation function • 208

Current (Torque) Limit • 126

Current control • 248

Current jerk response • 213

Current jerk response with the activated saturation characteristic line • 213

Cut-off frequency for the field weakening range • 180

D

D/A-Monitor • 300

Deadband following error • 214

Debouncing
Limit switch, machine zero and input 0 • 123

Defining jerk / ramps • 124

Defining the reference system • 100

Defining the STOP function • 135

Definition of the states of the programmable status bits (PSBs): • 278

Demand behavior • 186

Description of jerk • 124

Determination of the commutation settings • 180

Devices with the STO (=safe torque off) safety function • 77

Digital inputs/outputs • 65

Digitale Ein-/Ausgänge (Stecker X12) • 64

Digitale Ein-/Ausgangsoption M12 (I12) • 347

Dimensions of the braking resistors • 335

Direktantriebe • 309

Display of the commutation error in incremental feedback systems • 207

Display of the measurement point at the cursor position • 260

Display of the measurement result • 259

Distinction between signals and systems • 261

Disturbance behavior • 186

Disturbance jerk response • 190

D-term of the KD velocity controller • 193

Dynamic positioning • 139

Dynamic stiffness • 189

Dynamics of a control • 182

E

E/A - Belegung • 131, 271

E/A-Belegung, Steuer- und Zustandswort bei Steuerung über COM - Schnittstelle • 130, 271

E/A-Schnittstelle X12 / X22 / SSK22 • 344

EAM06

Klemmenblock für Ein- und Ausgänge • 339
 Effect of the notch filter • 211
 Eingangssimulation • 226
 Einleitung • 10, 164
 Einsatzbedingungen für die UL-Zulassung
 Compax3H • 23
 Einsatzbedingungen für die UL-Zulassung
 Compax3S • 20
 Einsatzbedingungen für die UL-Zulassung
 PSUP • 22
 Electronic gearbox (Gearing) • 145
 Electronic simulation of a disturbance torque
 jerk with the disturbance current jerk • 190
 EMC feedforward • 204
 EMC measures • 312
 Emergency stop and protective door
 monitoring without external safety switching
 device. • 90
 Encoder A/B 5V, step/direction or SSI
 feedback as signal source • 150
 Encoder bypass with Feedback module F12
 (for direct drives) • 134
 Encoder cable • 324
 Encoderkopplung von 2 Compax3 - Achsen /
 SSK29 • 345
 Encodernachbildung • 134
 EnDat - Kabel • 322
 Energizing the axis (example) • 275
 Error
 Position difference between load mounted and
 motor feedback too high • 155
 Error history • 275
 Error response • 147
 Ersatzschaltbild - Daten für eine Phase • 178
 ETHERNET-RS485 NetCOM 113 adapter •
 283
 Example
 Setting the Oscilloscope • 162
 Example 1
 Reg comes after the reg restriction window •
 142
 Example 2
 Reg within the reg restriction window • 142
 Example 3
 Reg is missing or comes after termination of
 the RegSearch motion set • 143
 Example 4
 Reg comes before the reg restriction window •
 144
 Example 5
 The registration mark comes after the reg
 restriction window, registration mark can,
 however, not be reached without direction
 reversal • 144
 Examples include
 Control via COM port • 275
 Excitation Signal • 245
 Extended cascade (structure variant 1) • 200
 Extended cascade structure (structure variant
 2 with disturbance variable observer) • 202
 External braking resistors • 325
 External Moment of Inertia • 177

external position correction • 153
 External setpoint generation • 217

F

Feedback error compensation • 171
 Feedforward channels • 198
 Fehler • 301
 Ferrite • 33
 Filter • 204
 Flow chart controller optimization of a direct
 drive • 223
 Following Error (Position Error) • 175
 Following error limit • 128
 Fremdmotor • 176
 Frequency response of the notch filter. • 212
 Frequency settings • 252
 Frequenzgang des P-TE Gliedes (Betrag und
 Phase) • 185
 Front connector • 40
 Function principle of the automatic
 commutation with movement • 209
 Functionality of the measurement • 239, 242

G

Gain alignment • 232
 Gebersysteme für Direktantriebe • 310
 General Description • 75
 General drive • 99
 General layout of the table • 277
 Gerätezuordnung • 10

H

Hardware-Endgrenzen • 122
 HEDA (motion bus) - Option M11 • 348
 Homing modes with home switch (on X12/14) •
 108

I

I/O assignment for control via the Compax3
 inputs/outputs • 129
 I²t - monitoring of the motor • 172
 Ignore zone (example) • 137, 275
 Important terms and explanations • 75
 Inbetriebnahme Compax3 • 94
 Inbetriebnahmefenster • 215
 Increased following error • 170
 Influence of the feedforward measures • 198
 Input wiring of digital inputs • 347
 Instable behavior • 171
 Installation instructions Compax3M • 38
 Installation und Freischaltung des
 ServoSignalAnalyzers • 235
 Intended use • 76
 Interface • 169
 Interface cable • 342
 Interface cable order code • 307
 Internal setpoint generation • 215
 Introduction observer • 204

J

Jerk limitation • 124

Jerk value • 124

K

Kommunikation im Achsverbund (Stecker X30, X31) • 59

Kommutierungseinstellungen • 172

Kondensatormodul ModulC4 • 338

Konfiguration • 94, 166

L

Lastidentifikation • 215, 229

Lastregelung • 153, 204

Leak effect and windowing • 240

LEDs • 27, 28

Level • 65

Limit and monitoring settings • 126, 178

Limitation behavior • 188

Limitation of the control voltage • 198

Linear motors • 311

Linear Systems (LTI System) • 262

Linear two mass system • 265

Linearized motor characteristic lien for different operating points • 173

Load control signal image • 155

Logic proximity switch types • 65

Luenberg observer • 204

M

Machine Zero • 103

Machine zero modes overview • 106

Machine zero modes without home switch • 114

Machine zero only from motor reference • 116

Machine zero run (example) • 275

Machine zero speed and acceleration • 119

Main flow chart of the controller optimization • 218

Main voltage supply C3S connector X1 • 34

Mains connection Compax3H • 56

Mains filter • 312

Mains filter for NFI01/03 • 314

Mains filter for PSUP30 • 319

Mains filter NFI01/01 • 313

Mains filter NFI01/02 • 313

Mains filter NFI02/0x • 314

Mains filter NFI03/01& NFI03/03 • 315

Mains filter NFI03/02 • 316

Mains supply PSUP (mains module) X41 • 44

Manual motion (example) • 275

Mass inertia • 167

Maximum operating speed • 128

Meaning of the status LEDs - Compax3 axis controller • 27

Measure reference • 100

Measurement of frequency responses • 242

Measurement of frequency spectra • 239

Measurement of the motor temperature of Compax3M (axis controller) • 49

Mechanical system • 249, 263

MN-M 1,2

Limit switch as machine zero • 117

MN-M 11...14

With direction reversal switches on the negative side • 113

MN-M 128/129

Stromschwelle while moving to block • 114

MN-M 130, 131

Acquire absolute position via distance coding • 116

MN-M 132, 133

Determine absolute position via distance coding with direction reversal switches • 118

MN-M 17,18

Limit switch as machine zero • 115

MN-M 19,20

MN-Initiator = 1 on the positive side • 108

MN-M 21,22

MN Initiator = 1 on the negative side • 109

MN-M 23...26

Direction reversal switches on the positive side • 110

MN-M 27...30

Direction reversal switches on the negative side • 110

MN-M 3,4

MN-Initiator = 1 on the positive side • 111

MN-M 33,34

MN at motor zero point • 116

MN-M 35

MN (machine zero) at the current position • 114

MN-M 5,6

MN-Initiator = 1 auf der negativen Seite • 112

MN-M 7...10

Direction reversal switches on the positive side • 113

Mode 1

Time and maximum values are deduced from Compax3 input values • 266

Mode 2

Compax3 input values are deduced from times and maximum values • 267

Modem cable SSK31 • 346

Modem MB-Connectline MDH 500 / MDH 504 • 284

Monitor information • 157

Motion cycle with feedforward measures • 199

Motion profile at jerk-controlled setpoint generation • 216

Motion set • 228

Motor - Dauerauslastung: • 172

Motor / Motor brake C3S connector X3 • 33

Motor / motor brake Compax3M (axis controller) • 48

Motor / Motorbremse C3H • 55

Motor cable • 323

Motor characteristic line of a synchronous servo motor (torque via velocity) • 168

Motor Connection • 33

Motor holding brake • 33

Motor output filter • 317

Motor output filter MDR01/01 • 317

Motor output filter MDR01/02 • 318

Motor output filter MDR01/04 • 317
 Motor parameters • 176, 204
 Motor parameters relevant for the control • 167
 Motor pulse usage • 174
 Motor reference point • 177
 Motor selection • 96
 Motor types supported • 177
 Mounting and dimensions • 66
 Mounting and dimensions C3H • 72
 Mounting and dimensions Compax3S • 66
 Mounting and dimensions Compax3S0xxV2 • 66
 Mounting and dimensions Compax3S100V2 and S0xxV4 • 67
 Mounting and dimensions Compax3S150V2 and S150V4 • 68
 Mounting and dimensions Compax3S300V4 • 69
 Mounting and dimensions PSUP/C3M • 70
 Mounting and dimensions PSUP10/C3M050D6, C3M100D6, C3M150D6 • 70
 Mounting and dimensions PSUP20/PSUP30/C3M300D6 • 71
 Mounting distances, air currents Compax3H050V4 • 73
 Mounting distances, air currents Compax3H090V4 • 73
 Mounting distances, air currents Compax3H1xxV4 • 74
 MoveAbs und MoveRel • 140

N

Netzrosseln • 319
 Noise • 170
 Nominal point • 173
 Nominal point data • 167
 Non-linearities and their effects • 245
 Notch filter • 211
 Note on error switch-off • 81
 Notes on the STO function • 80

O

Objekt Overview I12 T11 • 296
 Offset alignment • 231
 Open/Closed Loop frequency response measurement • 244
 Operating and status field • 257
 Operating mode / I/O assignment • 129
 Operating Principle • 226
 Operation with MultiTurn emulation • 105
 Operator control module BDM • 339
 Optimierung • 156
 Optimization parameter Advanced • 203
 Optimization window • 156
 Optimize motor reference point and switching frequency of the motor current • 96
 Option M10 = HEDA (M11) & I/Os (M12) • 349
 Options M1x • 347
 Order code • 302
 Order Code braking resistors • 305

Order code device Compax3 • 303
 Order code for mains module PSUP • 304
 Oscillating plant • 182
 Oscilloscope operating mode switch: • 159
 Other • 211
 Other settings • 254
 Overview of the user interface • 248

P

Parameterization by 3 objects. • 212
 Parker Motor • 176
 Parker Servomotoren • 309
 Path optimized positioning • 135
 PC - PSUP (Mains module) • 59
 PC <-> C3M device combination (USB) • 281
 PC <-> Compax3 (RS232) • 279
 PC <-> Compax3 (RS485) • 280
 Permissible braking pulse power
 BRM04/01 with C3S150V2 • 331
 BRM04/01 with C3S300V4 • 332
 BRM04/02 with C3S150V2 • 332
 BRM04/02 with C3S300V4 • 333
 BRM04/03 with C3S300V4 • 333
 BRM05/01 with C3S063V2 • 330
 BRM05/01 with C3S075V4 • 330
 BRM05/02 with C3S075V4 • 331
 BRM08/01 with C3S015V4 / C3S038V4 • 327
 BRM08/01 with C3S025V2 • 328
 BRM09/01 with C3S100V2 • 328
 BRM10/01 with C3S150V4 • 329
 BRM10/02 with C3S150V4 • 329
 BRM11/01 with C3H0xxV4 • 334
 BRM12/01 with C3H1xxV4 • 334
 BRM13/01 with PSUP10D6 • 335
 BRM14/01 with PSUP10D6 • 335
 Permissible braking pulse powers of the braking resistors • 326
 Plug assignment Compax3S0xx V2 • 32, 33, 34, 35, 58, 61
 Position control • 250
 Position correction • 153
 Position measurement external • 153
 Position mode in reset operation • 135
 Positioning after homing run • 103
 Positioning window - Position reached • 126
 Power supply • 34
 Power supply connector X1 for 3AC 400VAC/480VAC-C3S devices • 36
 Power supply plug X1 for 1 AC 230VAC/240VAC devices • 34
 Power supply plug X1 for 3AC 230VAC/240VAC devices • 34
 Power supply voltage DC C3H • 57
 Prerequisites for the automatic commutation • 208
 Principle • 229
 Proceeding during controller optimization • 217
 Process of the automatic determination of the load characteristic value (load identification) • 230

ProfileViewer for the optimization of the motion profile • 266
 Programmable status bits (PSBs) • 139, 140
 PSUP/Compax3M Connections • 40
 P-TE - Symbol • 184
 P-term KV position loop • 193

Q

Quality of different feedback systems • 169

R

Ramp upon error / deenergize • 125
 Reaction times • 130
 Recommendations for preparing the modem operation • 294
 Reduction of the current ripple • 176
 Ref X11 / SSK21 • 344
 Reference point 1
 higher velocity at reduced torque • 173
 Reference point 2
 Increased torque thanks to additional cooling • 174
 Regelungsmaßnahmen für reibungsbehaftete Antriebe • 214
 Reg-related positioning (RegSearch, RegMove) • 141
 Reg-related positioning / defining ignore zone • 137
 Reibungskompensation • 215
 Relevant application parameters • 175
 Remote diagnosis via Modem • 292
 Resolution • 169
 Resolver • 61
 Resolver / Feedback (connector X13) • 61
 Resolver cable • 321
 Resonance points and their causes • 264
 Response • 188
 Rigidity • 189
 Rotary servo motors • 311
 Rotary two mass system • 264
 Rotor time constant • 180
 RS232 - Kabel / SSK1 • 342
 RS232 / RS485 interface (plug X10) • 58
 RS232 plug assignment • 58
 RS485 - Kabel zu Pop / SSK27 • 343
 RS485 plug assignment • 58
 RS485 settings values • 287

S

Safe torque off • 75
 Safe torque off basic function • 83
 Safe torque off description • 83
 Safety function - STO (=safe torque off) • 75
 Safety instructions • 14
 Safety instructions concerning the frequency response measurement • 242
 Safety notes for the STO function in the Compax3M • 86
 Safety switching circuits • 85
 Safety technology option S3 for Compax3M (axis controller) • 49
 Safety-conscious working • 14

Sättigungsverhalten • 179, 213
 Saturation values • 169
 Satztable beschreiben • 138
 Scope • 157
 Scope of delivery • 10
 Selection of the signal or system to be measured. • 248
 Selection of the supply voltage used • 95
 ServoSignalAnalyzer - function range • 233
 Set selection • 140
 Setpoint and disturbance behavior of a control loop • 186
 Setpoint generation • 215
 Setting the axis function • 60
 Setting the time basis XDIV • 159
 Settings for channels 1..4 • 160
 Setup and optimization of the control • 194
 Setup mode • 227
 Shifting the working point into a linear range • 246
 Signal analysis overview • 234
 Signal processing of the analog input 0 • 151
 Signal processing of the analog inputs • 232
 Signal source of the load feedback system • 148
 Signalfilterung bei externer Sollwertvorgabe • 224
 Signalfilterung bei externer Sollwertvorgabe und elektronischem Getriebe • 225
 Signalflussplan Luenberger-Beobachter • 205
 Signalquelle für Gearing wählen • 148
 Signalquelle HEDA • 149
 Signalschnittstellen • 61
 SinCos© cable • 322
 Slip • 153
 Slip Frequency • 179
 Software end limits • 120
 Software zur Unterstützung der Konfiguration, Inbetriebnahme und Optimierung • 165
 Special functions • 161
 Special safety instructions • 15
 Speed control • 253
 Speed specification (Velocity) • 147
 Stability problem in the high-frequency range: • 183
 Stability problem in the low-frequency range: • 183
 Stability, attenuation • 182
 Standard • 194
 Standard cascade structure • 195
 Standard optimization parameters • 196
 Start edge (example) • 275
 Static stiffness • 189
 Status diagram • 270
 Status LEDs • 27, 28
 Status values • 300
 Status word • 130
 Stecker- und Pinbelegung C3H • 53
 Stecker- und Pinbelegung C3S • 30
 Step response of a delay component • 184
 Step response of the velocity loop depending on the optimization parameter • 192

Control word • 130
 Steuerwort • 132
 Steuerwort • 273
 STO (= safe torque off) with Compax3m
 (Option S1) • 85
 STO (= safe torque off) with Compax3S • 78
 STO delay times • 79, 87
 STO function description • 89
 STO function test • 91
 STO function with safety switching device via
 Compax3M inputs • 88
 STO Principle (= Safe Torque Off) with
 Compax3S • 78
 STO Test-Protokoll-Vorschlag
 (Sicherheitsoption S1) • 92
 Stop command (Stop) • 147
 Storage • 13
 Strom auf dem Netz-PE (Ableitstrom) • 24
 Structure • 292
 Structure of a cascade control • 188
 Structure of a control • 182
 Supply networks • 24
 Switching frequency of the motor current /
 motor reference point • 175

T

Teach machine zero • 114
 Technical Characteristics STO Compax3S • 84
 Technische Daten • 350
 Technische Daten der Compax3M S1-Option •
 93
 Temperature switch PSUP (mains module) •
 47
 Test functions • 187
 The calculation of the physically possible
 acceleration • 216
 Time frame signal source master • 152
 Time function and power density spectrum of
 Compax3 setpoint generator with different
 jerk settings • 217
 Tips • 231
 Too high overshoot on velocity • 170
 Toothed belt drive as two mass system • 265
 Toroidal core ferrite • 33
 Torque motors • 311
 Tracking filter • 224
 Traditional generation of a disturbance
 torque/force jerk • 190
 Travel Limit Settings • 120
 Trigger settings • 161
 Turning the motor holding brake on and off •
 268
 Type specification plate • 12
 Type specification plate data • 178
 Typical problems of a non optimized control •
 170

U

Usage in accordance with intended purpose •
 14
 USB - RS232 converter • 58
 USB-RS485 Adapter Moxa Uport 1130 • 282

User interface • 158

V

Velocity Loop P Term • 192
 Velocity, bandwidth • 183
 Verpackung, Transport, Lagerung • 13
 Voltage decoupling • 204
 Vorgehen bei der Konfiguration,
 Inbetriebnahme und Optimierung • 164

W

Warranty conditions • 16
 Wiring of analog interfaces • 63
 Wiring of the motor output filter • 318
 With direction reversal switches • 109, 112,
 117
 With motor reference point • 111, 116
 With upper mounting, the housing design may
 be different • 71
 Without direction reversal switches • 108, 111
 Without motor reference point • 108, 114
 Write set table (example) • 275
 Wrongly set notch filter • 211

X

X1 • 34
 X10 • 58
 X11 • 63
 X12 • 64
 X13 • 61
 X14 Safety technology option S1 for
 Compax3M (axis controller) • 49
 X2 • 35
 X3 • 33
 X4 • 32

Z

Zubehör Compax3 • 309
 Zustandswort 1 & 2 • 133, 274